

Hold 72	Skive 1	Jeppe Niss	
-------------------	-------------------	-------------------	--

15m	Mou & Omegns Skf.	BK3
-----	-------------------	-----

24.10.2013	15 meter riffelstævne 2013	Aalborg Skyttekreds
------------	----------------------------	---------------------

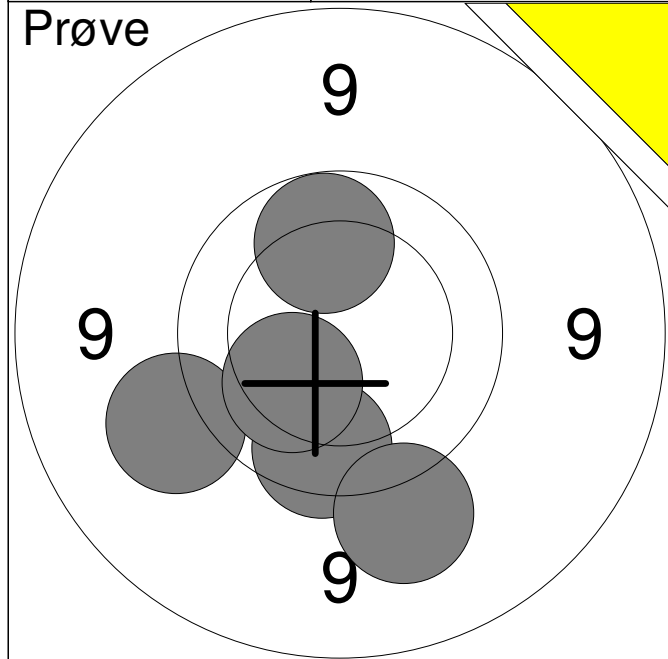

1:	9.8	↓
2:	9.3	↓
3:	9.4	↙
4:	10.2	↙
5:	10.0	↑
Serie	47.0	
Total	0.0	

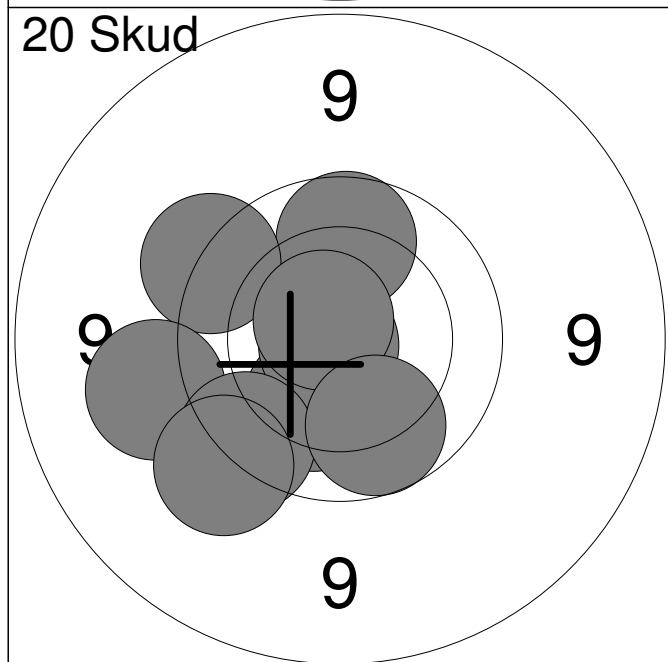

1:	10.4	↓
2:	9.9	↑
3:	9.6	↖
4:	10.2	↓
5:	9.3	↙
6:	10.8x	↙
7:	9.7	↙
8:	10.7x	↗
9:	9.5	↙
10:	9.9	↓
Serie	94.0	
Total	94.0	

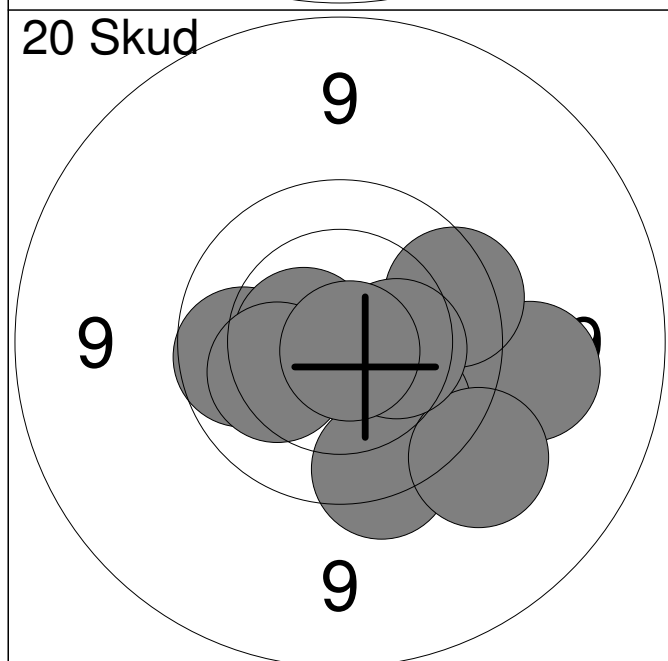

11:	9.3	→
12:	9.9	↙
13:	10.0	↓
14:	10.6x	↙
15:	10.2	↙
16:	9.7	↓
17:	9.8	→
18:	9.4	↙
19:	10.3	→
20:	10.8x	↓
Serie	95.0	
Total	189.0	

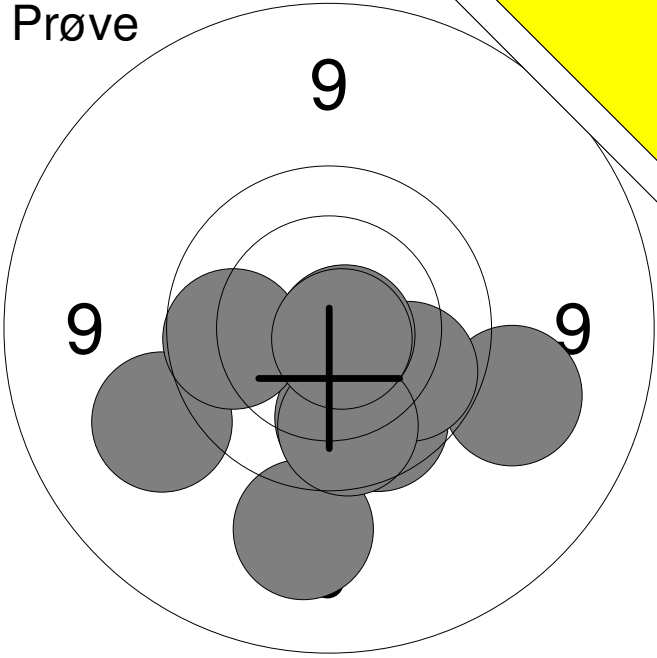
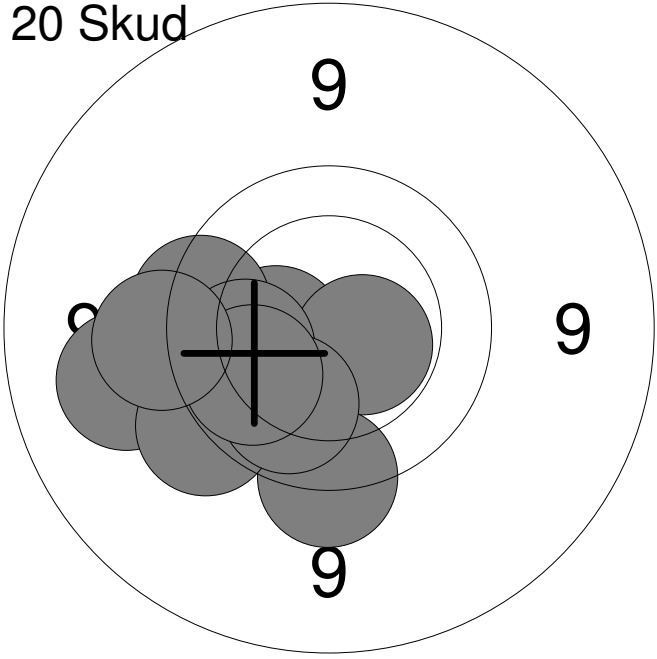
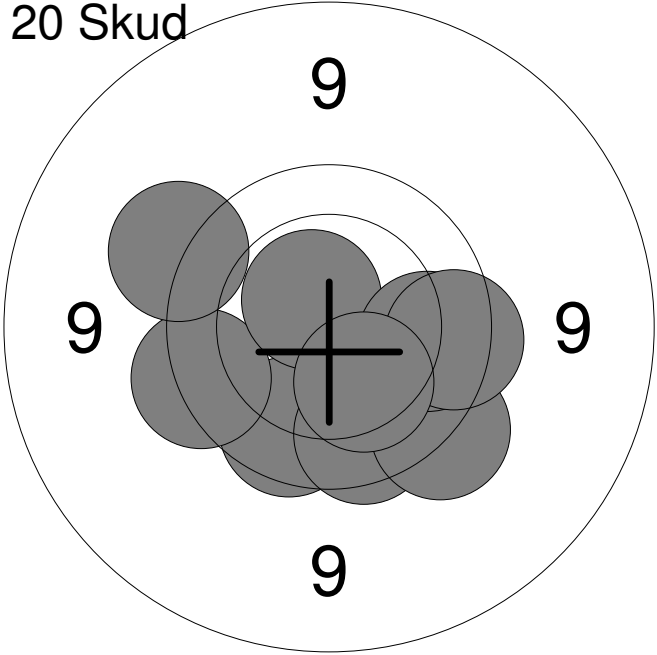
Hold	Skive	Jens Niss	
72	5	15m	Mou & Omegns Skf. ÅK2
24.10.2013	15 meter riffelstævne 2013	Aalborg Skyttekreds	
Prøve 	1:	9.9	↘
	2:	9.3	↙
	3:	10.0	↘
	4:	9.3	↘
	5:	9.3	↘
	6:	10.0	↘
	7:	9.9	↙
	8:	9.9	↘
	9:	10.8x	↘
	10:	10.8x	↘
	Serie		94.0
Total		0.0	
20 Skud 	1:	10.4	←
	2:	9.2	←
	3:	10.6x	↘
	4:	9.6	↘
	5:	9.6	↙
	6:	9.7	↙
	7:	10.0	←
	8:	10.0	↘
	9:	10.0	↙
	10:	9.5	←
	Serie		95.0
Total		95.0	
20 Skud 	11:	9.9	↘
	12:	9.9	↘
	13:	9.7	↙
	14:	9.8	↘
	15:	9.6	↘
	16:	10.6x	↗
	17:	9.9	↘
	18:	9.5	↗
	19:	9.7	↘
	20:	10.2	↘
	Serie		92.0
Total		187.0	

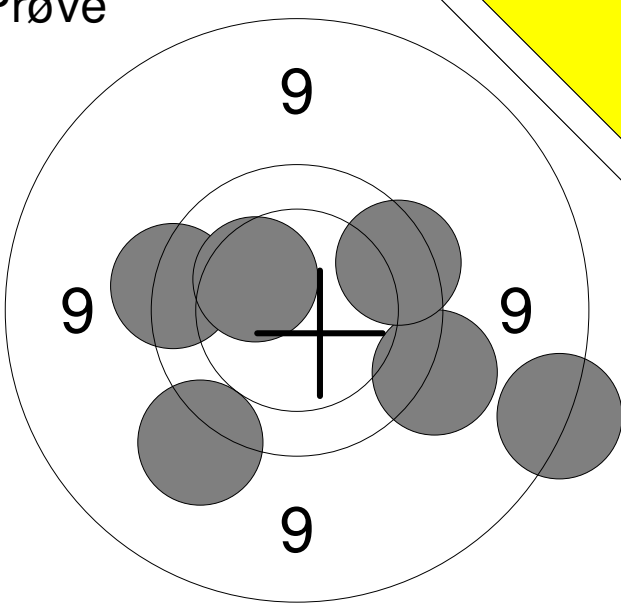
<p>Prøve</p> 	<table style="width:100%; border-collapse: collapse;"> <tr><td style="width:10%;">1:</td><td style="width:20%;">9.4</td><td style="width:10%; text-align: right;">↙</td></tr> <tr><td>2:</td><td>9.5</td><td style="text-align: right;">→</td></tr> <tr><td>3:</td><td>9.7</td><td style="text-align: right;">←</td></tr> <tr><td>4:</td><td>8.7</td><td style="text-align: right;">↘</td></tr> <tr><td>5:</td><td>10.3</td><td style="text-align: right;">↗</td></tr> <tr><td>6:</td><td>9.8</td><td style="text-align: right;">→</td></tr> </table>	1:	9.4	↙	2:	9.5	→	3:	9.7	←	4:	8.7	↘	5:	10.3	↗	6:	9.8	→
1:	9.4	↙																	
2:	9.5	→																	
3:	9.7	←																	
4:	8.7	↘																	
5:	10.3	↗																	
6:	9.8	→																	
<table style="width:100%; border-collapse: collapse;"> <tr> <td style="width:80%;">Serie</td> <td style="text-align: right;">54.0</td> </tr> <tr> <td>Total</td> <td style="text-align: right;">0.0</td> </tr> </table>		Serie	54.0	Total	0.0														
Serie	54.0																		
Total	0.0																		

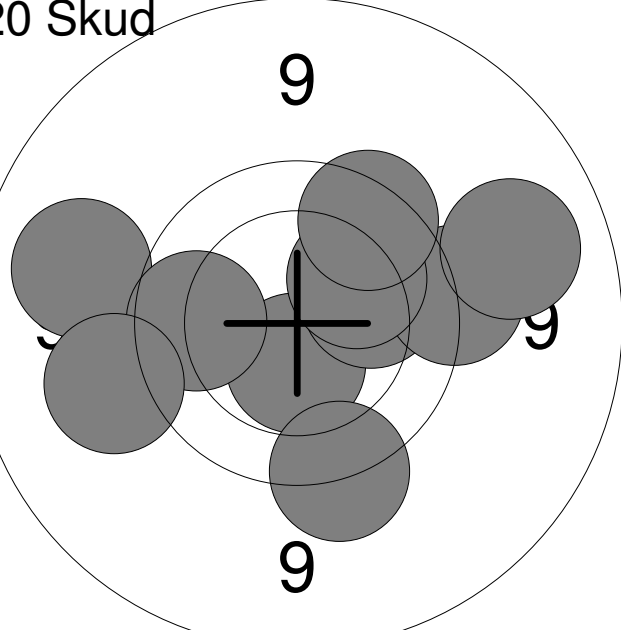
<p>20 Skud</p> 	<table style="width:100%; border-collapse: collapse;"> <tr><td style="width:10%;">1:</td><td style="width:20%;">10.5x</td><td style="width:10%; text-align: right;">↓</td></tr> <tr><td>2:</td><td>10.1</td><td style="text-align: right;">→</td></tr> <tr><td>3:</td><td>9.5</td><td style="text-align: right;">→</td></tr> <tr><td>4:</td><td>9.2</td><td style="text-align: right;">←</td></tr> <tr><td>5:</td><td>10.1</td><td style="text-align: right;">↗</td></tr> <tr><td>6:</td><td>9.1</td><td style="text-align: right;">→</td></tr> <tr><td>7:</td><td>9.9</td><td style="text-align: right;">←</td></tr> <tr><td>8:</td><td>9.7</td><td style="text-align: right;">↗</td></tr> <tr><td>9:</td><td>9.6</td><td style="text-align: right;">↓</td></tr> <tr><td>10:</td><td>9.3</td><td style="text-align: right;">←</td></tr> </table>	1:	10.5x	↓	2:	10.1	→	3:	9.5	→	4:	9.2	←	5:	10.1	↗	6:	9.1	→	7:	9.9	←	8:	9.7	↗	9:	9.6	↓	10:	9.3	←
1:	10.5x	↓																													
2:	10.1	→																													
3:	9.5	→																													
4:	9.2	←																													
5:	10.1	↗																													
6:	9.1	→																													
7:	9.9	←																													
8:	9.7	↗																													
9:	9.6	↓																													
10:	9.3	←																													
<table style="width:100%; border-collapse: collapse;"> <tr> <td style="width:80%;">Serie</td> <td style="text-align: right;">93.0</td> </tr> <tr> <td>Total</td> <td style="text-align: right;">93.0</td> </tr> </table>		Serie	93.0	Total	93.0																										
Serie	93.0																														
Total	93.0																														

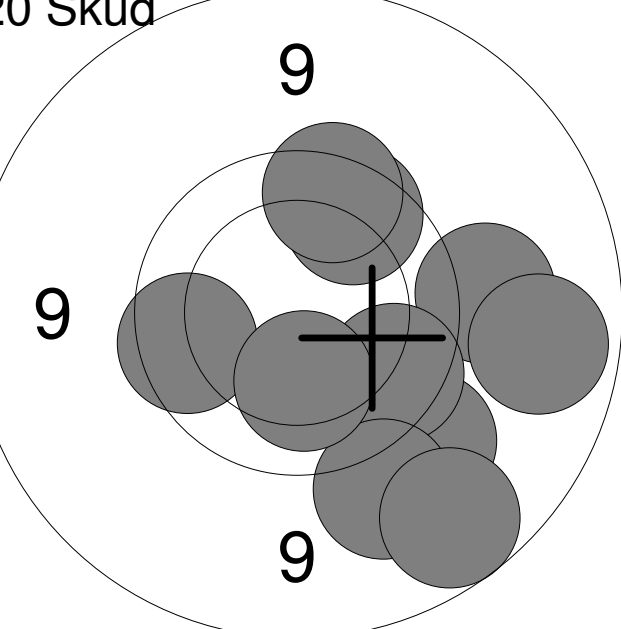
<p>20 Skud</p> 	<table style="width:100%; border-collapse: collapse;"> <tr><td style="width:10%;">11:</td><td style="width:20%;">9.8</td><td style="width:10%; text-align: right;">↗</td></tr> <tr><td>12:</td><td>9.7</td><td style="text-align: right;">↗</td></tr> <tr><td>13:</td><td>9.4</td><td style="text-align: right;">↘</td></tr> <tr><td>14:</td><td>9.4</td><td style="text-align: right;">→</td></tr> <tr><td>15:</td><td>9.8</td><td style="text-align: right;">←</td></tr> <tr><td>16:</td><td>9.8</td><td style="text-align: right;">↘</td></tr> <tr><td>17:</td><td>9.3</td><td style="text-align: right;">↘</td></tr> <tr><td>18:</td><td>8.9</td><td style="text-align: right;">↘</td></tr> <tr><td>19:</td><td>9.0</td><td style="text-align: right;">→</td></tr> <tr><td>20:</td><td>10.2</td><td style="text-align: right;">↓</td></tr> </table>	11:	9.8	↗	12:	9.7	↗	13:	9.4	↘	14:	9.4	→	15:	9.8	←	16:	9.8	↘	17:	9.3	↘	18:	8.9	↘	19:	9.0	→	20:	10.2	↓
11:	9.8	↗																													
12:	9.7	↗																													
13:	9.4	↘																													
14:	9.4	→																													
15:	9.8	←																													
16:	9.8	↘																													
17:	9.3	↘																													
18:	8.9	↘																													
19:	9.0	→																													
20:	10.2	↓																													
<table style="width:100%; border-collapse: collapse;"> <tr> <td style="width:80%;">Serie</td> <td style="text-align: right;">90.0</td> </tr> <tr> <td>Total</td> <td style="text-align: right;">183.0</td> </tr> </table>		Serie	90.0	Total	183.0																										
Serie	90.0																														
Total	183.0																														

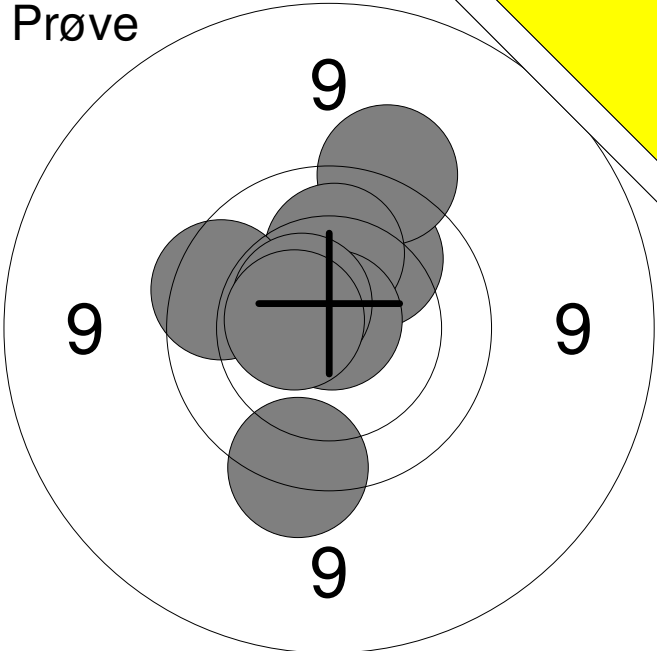
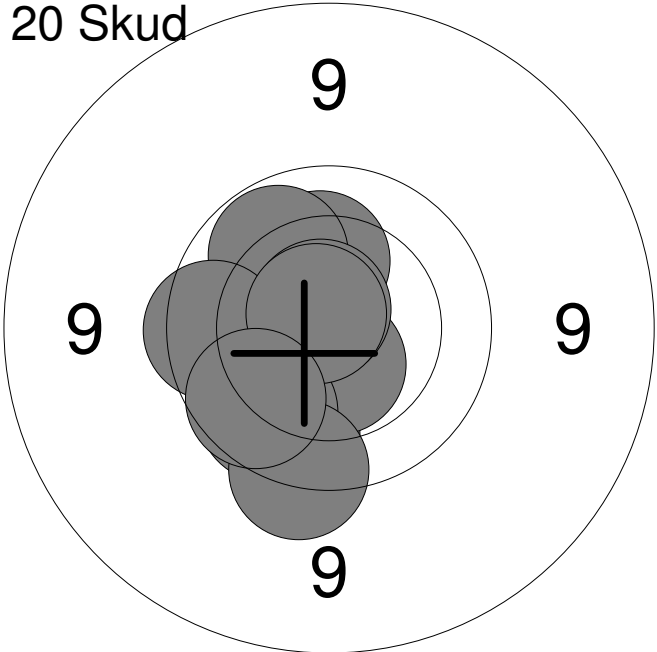
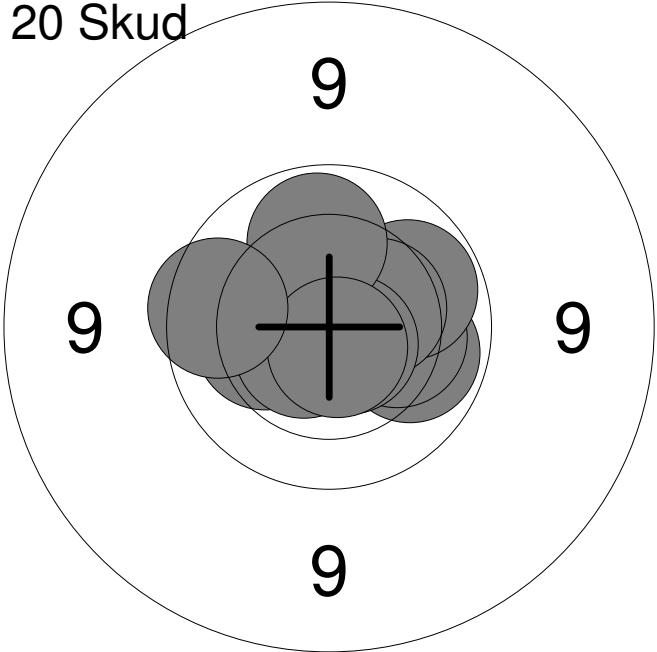
Hold	Skive	Frederik B. Sørensen	
72	9	15m	Løgstør Sportsskytteklub MJ2
24.10.2013	15 meter riffelstævne 2013	Aalborg Skyttekreds	
Prøve		1: 10.1 ↗	
		2: 9.5 ↗	
		3: 10.1 ↑	
		4: 10.9x ↗	
		5: 9.8 ←	
		6: 10.5x ↗	
		7: 9.6 ↓	
		8: 10.6x ←	
		Serie	77.0
		Total	0.0
20 Skud		1: 9.8 ↓	
		2: 10.2 ↑	
		3: 10.0 ↗	
		4: 9.8 ←	
		5: 10.6x ↓	
		6: 9.9 ↓	
		7: 9.6 ↓	
		8: 10.7x ↗	
		9: 10.7x ↗	
		10: 9.9 ↓	
		Serie	95.0
		Total	95.0
20 Skud		11: 10.0 →	
		12: 10.2 →	
		13: 10.0 →	
		14: 10.4 →	
		15: 10.2 ←	
		16: 10.7x ↓	
		17: 10.6x ←	
		18: 10.0 ↑	
		19: 10.7x ↓	
		20: 9.8 ←	
		Serie	99.0
		Total	194.0

Hold 72	Skive 10	Simon Andersen	
-------------------	--------------------	-----------------------	--

15m	Løgstør Sportsskytteklub	MJ1	
-----	--------------------------	-----	--

24.10.2013	15 meter riffelstævne 2013	Aalborg Skyttekreds	
------------	----------------------------	---------------------	--

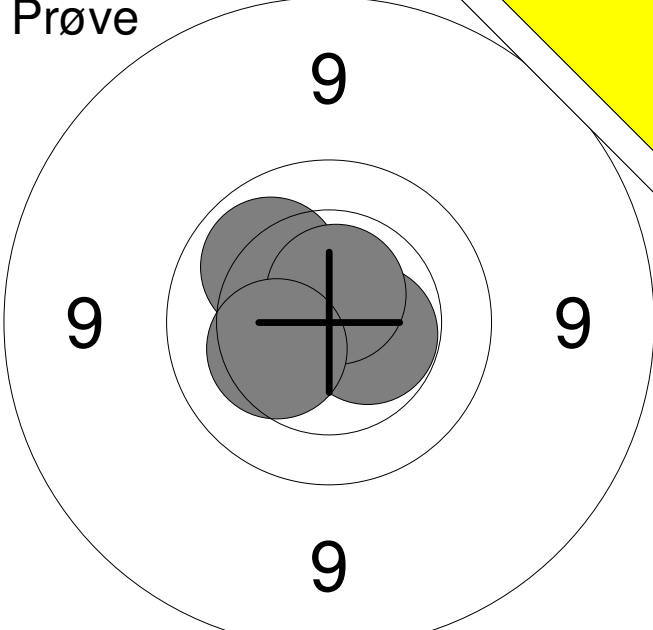
Prøve 	1:	10.1	↗
	2:	10.8x	↗
	3:	10.5x	→
	4:	10.6x	↑
	5:	10.3	↙
	Serie		50.0
Total		0.0	

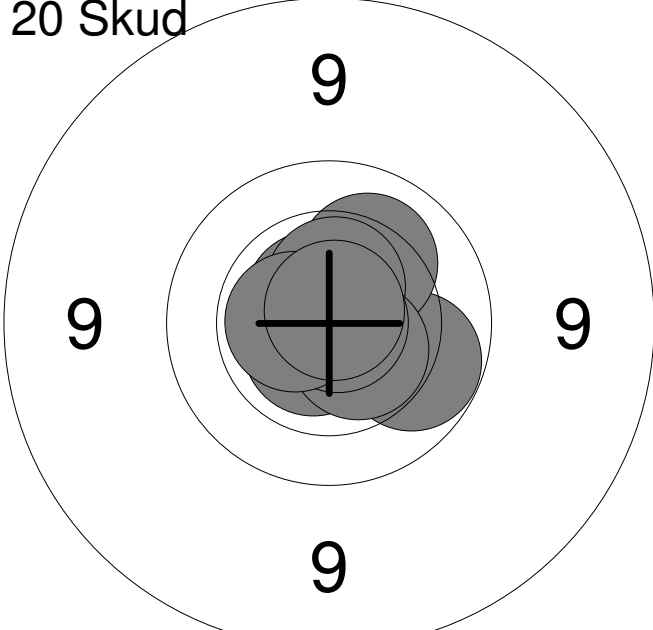
20 Skud 	1:	10.0	→
	2:	10.7x	↗
	3:	10.2	↗
	4:	10.8x	↗
	5:	10.6x	↙
	6:	10.6x	↑
	7:	10.5x	↘
	8:	10.9x	→
	9:	10.6x	←
	10:	10.8x	↑
	Serie		100.0
Total		100.0	

20 Skud 	11:	10.4	↑
	12:	10.4	↗
	13:	10.4	←
	14:	10.8x	↗
	15:	10.3	↗
	16:	10.6x	↗
	17:	10.7x	→
	18:	10.6x	↙
	19:	10.8x	←
	20:	10.3	→
	Serie		100.0
Total		200.0	

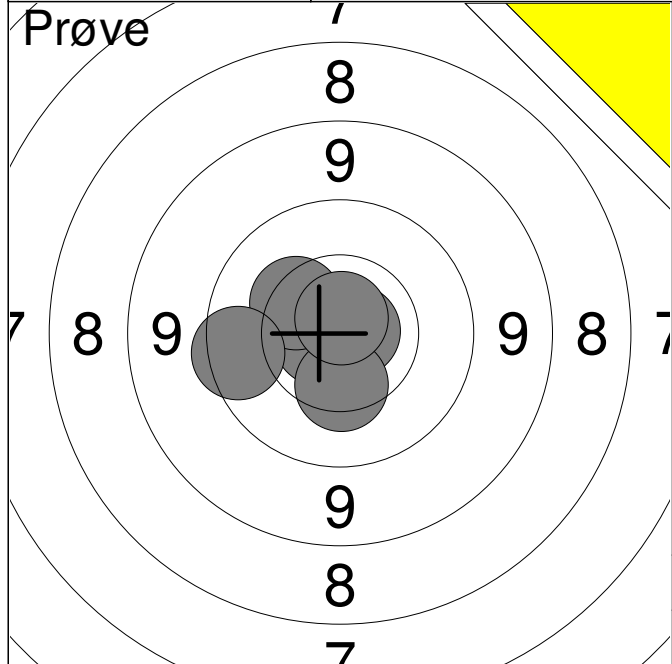

1:	10.7x	←
2:	10.8x	→
3:	10.3	↗
4:	9.7	←
5:	10.4	↓
6:	10.8x	↑
Serie		59.0
Total		0.0

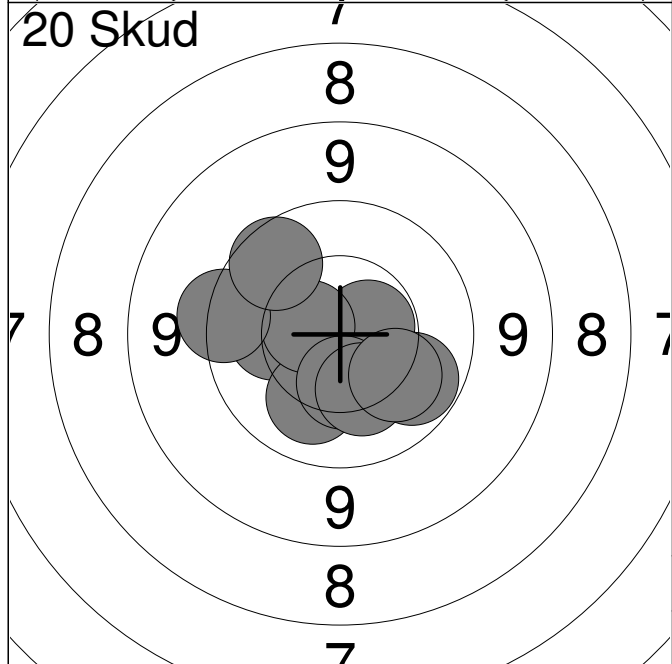

1:	10.6x	→
2:	10.2	←
3:	10.1	↘
4:	10.6	←
5:	10.0	↘
6:	10.4	↓
7:	9.5	←
8:	10.3	↘
9:	10.2	↘
10:	9.8	↗
Serie		98.0
Total		98.0

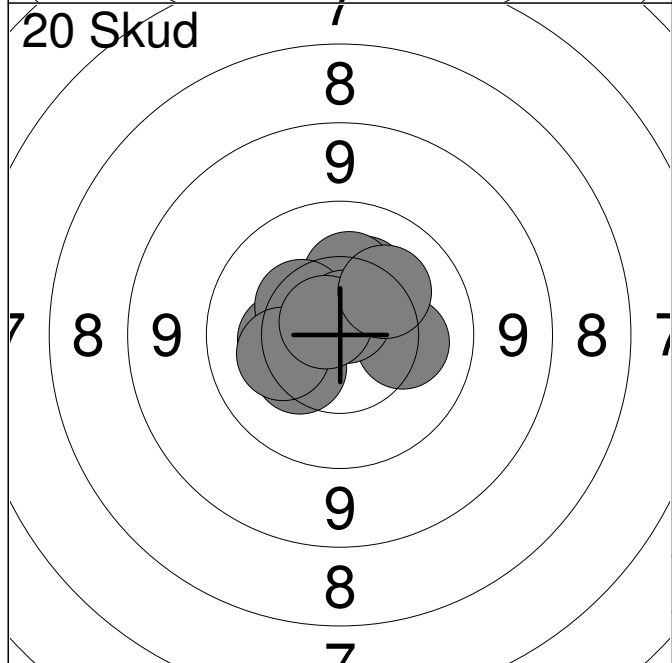

11:	10.3	↙
12:	10.3	←
13:	10.3	↗
14:	10.2	→
15:	10.3	↗
16:	10.4	↗
17:	10.3	←
18:	10.7x	↗
19:	10.7x	↗
20:	10.2	↗
Serie		100.0
Total		198.0

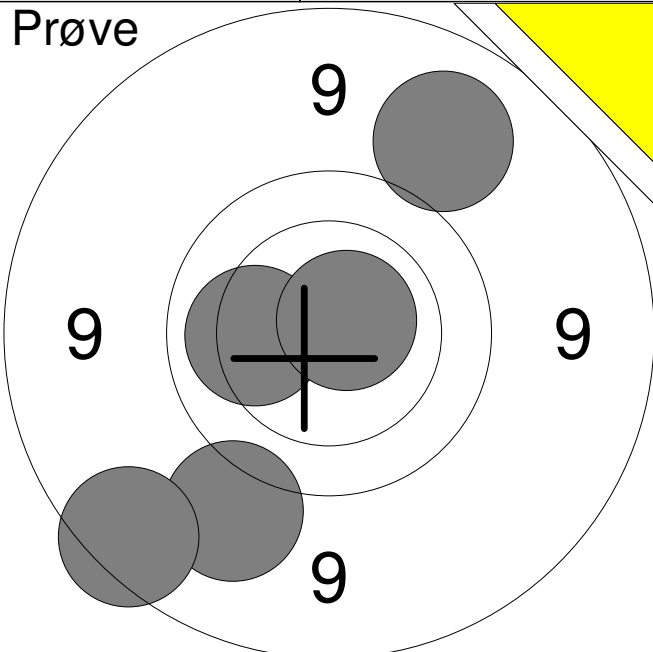
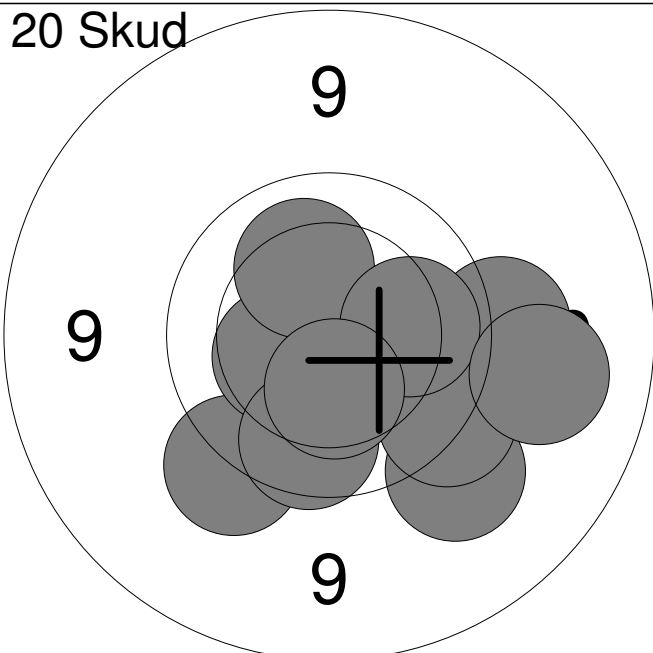
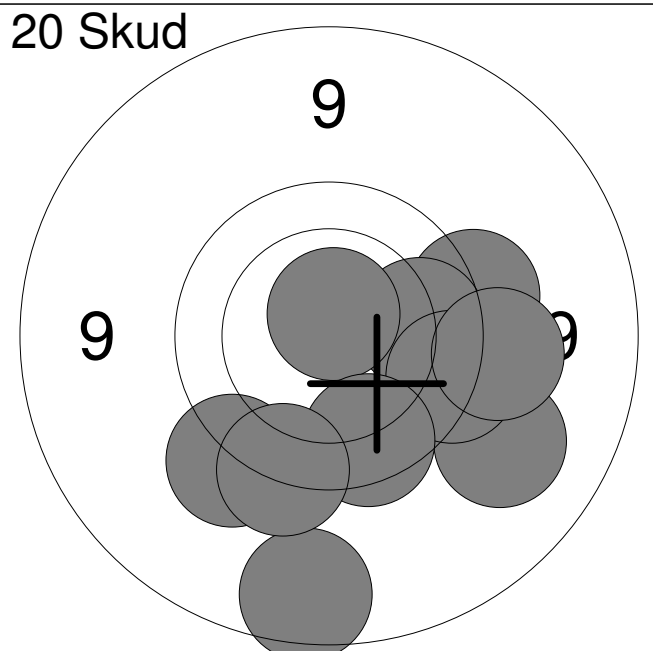
Hold	Skive	Sune Harbo Andersen	
72	12	15m	Mou & Omegns Skf. BK3
24.10.2013	15 meter riffelstævne 2013	Aalborg Skyttekreds	
Prøve 	1:	9.3	↙
	2:	10.1	←
	3:	10.7x	↗
	4:	9.1	↗
	5:	8.8	↙
	Serie	46.0	
	Total	0.0	
20 Skud 	1:	9.5	→
	2:	9.5	↙
	3:	10.4	←
	4:	9.4	↙
	5:	10.2	↗
	6:	9.9	↙
	7:	9.6	↙
	8:	10.1	→
	9:	9.2	→
	10:	10.4	↓
	Serie	94.0	
	Total	94.0	
20 Skud 	11:	9.6	→
	12:	9.2	↙
	13:	8.9	↓
	14:	9.9	→
	15:	9.7	→
	16:	10.7x	↗
	17:	9.5	↙
	18:	9.8	↙
	19:	9.4	→
	20:	9.6	↓
	Serie	90.0	
	Total	184.0	

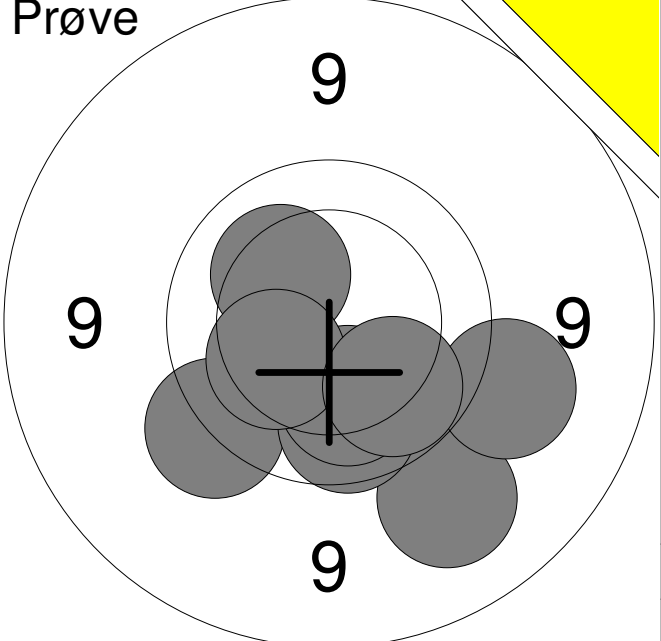
<p>Prøve</p> 	<table style="width:100%; border-collapse: collapse;"> <tr><td style="width:10%;">1:</td><td style="width:15%;">9.2</td><td style="width:10%; text-align: right;">↘</td></tr> <tr><td>2:</td><td>10.2</td><td style="text-align: right;">↗</td></tr> <tr><td>3:</td><td>9.6</td><td style="text-align: right;">↘</td></tr> <tr><td>4:</td><td>9.9</td><td style="text-align: right;">↘</td></tr> <tr><td>5:</td><td>10.1</td><td style="text-align: right;">↘</td></tr> <tr><td>6:</td><td>10.3</td><td style="text-align: right;">↘</td></tr> <tr><td>7:</td><td>9.4</td><td style="text-align: right;">↗</td></tr> <tr><td>8:</td><td>10.0</td><td style="text-align: right;">↘</td></tr> </table>	1:	9.2	↘	2:	10.2	↗	3:	9.6	↘	4:	9.9	↘	5:	10.1	↘	6:	10.3	↘	7:	9.4	↗	8:	10.0	↘
1:	9.2	↘																							
2:	10.2	↗																							
3:	9.6	↘																							
4:	9.9	↘																							
5:	10.1	↘																							
6:	10.3	↘																							
7:	9.4	↗																							
8:	10.0	↘																							
<table style="width:100%; border-collapse: collapse;"> <tr> <td style="width:10%;">Serie</td> <td style="width:80%;"></td> <td style="width:10%; text-align: right;">76.0</td> </tr> <tr> <td>Total</td> <td></td> <td style="text-align: right;">0.0</td> </tr> </table>		Serie		76.0	Total		0.0																		
Serie		76.0																							
Total		0.0																							

<p>20 Skud</p> 	<table style="width:100%; border-collapse: collapse;"> <tr><td style="width:10%;">1:</td><td style="width:15%;">10.0</td><td style="width:10%; text-align: right;">↙</td></tr> <tr><td>2:</td><td>9.0</td><td style="text-align: right;">←</td></tr> <tr><td>3:</td><td>10.3</td><td style="text-align: right;">↘</td></tr> <tr><td>4:</td><td>9.6</td><td style="text-align: right;">↘</td></tr> <tr><td>5:</td><td>9.8</td><td style="text-align: right;">↙</td></tr> <tr><td>6:</td><td>10.1</td><td style="text-align: right;">↗</td></tr> <tr><td>7:</td><td>9.9</td><td style="text-align: right;">↘</td></tr> <tr><td>8:</td><td>10.5x</td><td style="text-align: right;">↘</td></tr> <tr><td>9:</td><td>10.6x</td><td style="text-align: right;">↗</td></tr> <tr><td>10:</td><td>9.5</td><td style="text-align: right;">↘</td></tr> </table>	1:	10.0	↙	2:	9.0	←	3:	10.3	↘	4:	9.6	↘	5:	9.8	↙	6:	10.1	↗	7:	9.9	↘	8:	10.5x	↘	9:	10.6x	↗	10:	9.5	↘
1:	10.0	↙																													
2:	9.0	←																													
3:	10.3	↘																													
4:	9.6	↘																													
5:	9.8	↙																													
6:	10.1	↗																													
7:	9.9	↘																													
8:	10.5x	↘																													
9:	10.6x	↗																													
10:	9.5	↘																													
<table style="width:100%; border-collapse: collapse;"> <tr> <td style="width:10%;">Serie</td> <td style="width:80%;"></td> <td style="width:10%; text-align: right;">95.0</td> </tr> <tr> <td>Total</td> <td></td> <td style="text-align: right;">95.0</td> </tr> </table>		Serie		95.0	Total		95.0																								
Serie		95.0																													
Total		95.0																													

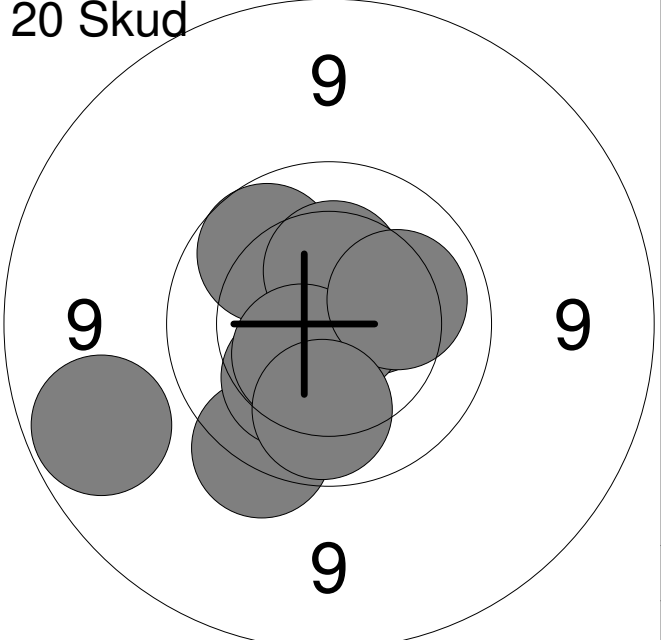
<p>20 Skud</p> 	<table style="width:100%; border-collapse: collapse;"> <tr><td style="width:10%;">11:</td><td style="width:15%;">9.9</td><td style="width:10%; text-align: right;">↗</td></tr> <tr><td>12:</td><td>9.7</td><td style="text-align: right;">↘</td></tr> <tr><td>13:</td><td>10.4</td><td style="text-align: right;">→</td></tr> <tr><td>14:</td><td>10.9x</td><td style="text-align: right;">→</td></tr> <tr><td>15:</td><td>10.4</td><td style="text-align: right;">↗</td></tr> <tr><td>16:</td><td>10.2</td><td style="text-align: right;">↘</td></tr> <tr><td>17:</td><td>10.5x</td><td style="text-align: right;">↘</td></tr> <tr><td>18:</td><td>10.2</td><td style="text-align: right;">→</td></tr> <tr><td>19:</td><td>9.0</td><td style="text-align: right;">↙</td></tr> <tr><td>20:</td><td>10.0</td><td style="text-align: right;">↘</td></tr> </table>	11:	9.9	↗	12:	9.7	↘	13:	10.4	→	14:	10.9x	→	15:	10.4	↗	16:	10.2	↘	17:	10.5x	↘	18:	10.2	→	19:	9.0	↙	20:	10.0	↘
11:	9.9	↗																													
12:	9.7	↘																													
13:	10.4	→																													
14:	10.9x	→																													
15:	10.4	↗																													
16:	10.2	↘																													
17:	10.5x	↘																													
18:	10.2	→																													
19:	9.0	↙																													
20:	10.0	↘																													
<table style="width:100%; border-collapse: collapse;"> <tr> <td style="width:10%;">Serie</td> <td style="width:80%;"></td> <td style="width:10%; text-align: right;">97.0</td> </tr> <tr> <td>Total</td> <td></td> <td style="text-align: right;">192.0</td> </tr> </table>		Serie		97.0	Total		192.0																								
Serie		97.0																													
Total		192.0																													

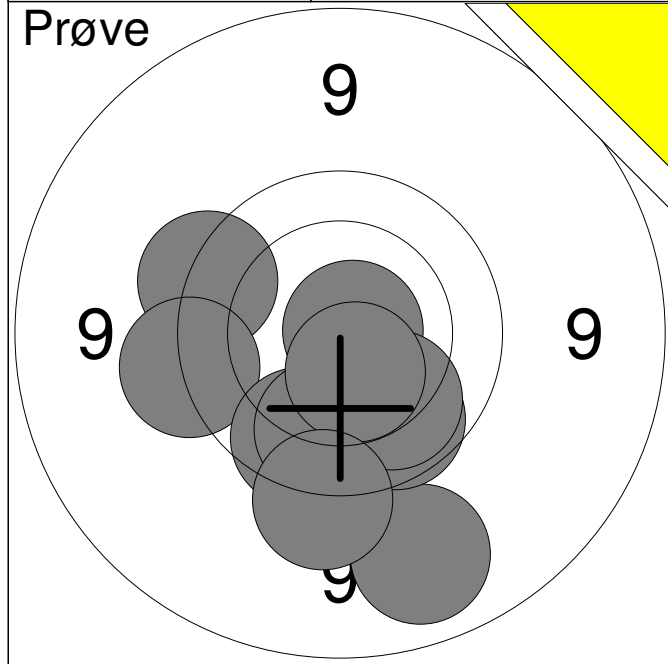

1:	9.6	↗
2:	9.1	↓
3:	10.8x	→
4:	9.9	↓
5:	9.6	←
6:	9.8	↓
7:	9.9	↓
8:	10.0	↓
9:	10.5x	↓
10:	9.5	↓
Serie		93.0
Total		0.0

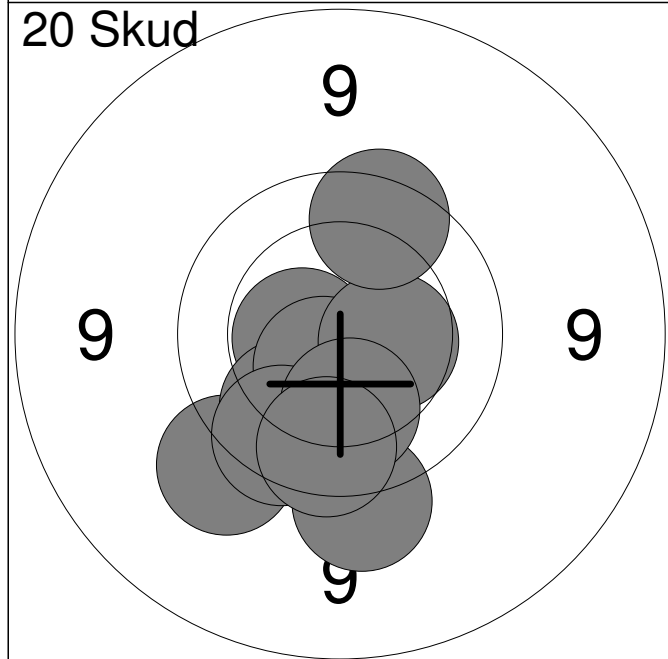

1:	9.5	↙
2:	10.5x	←
3:	10.0	↙
4:	10.6x	↙
5:	9.8	↙
6:	9.5	↓
7:	10.4	→
8:	9.8	↑
9:	10.1	↓
10:	9.8	↓
Serie		95.0
Total		95.0

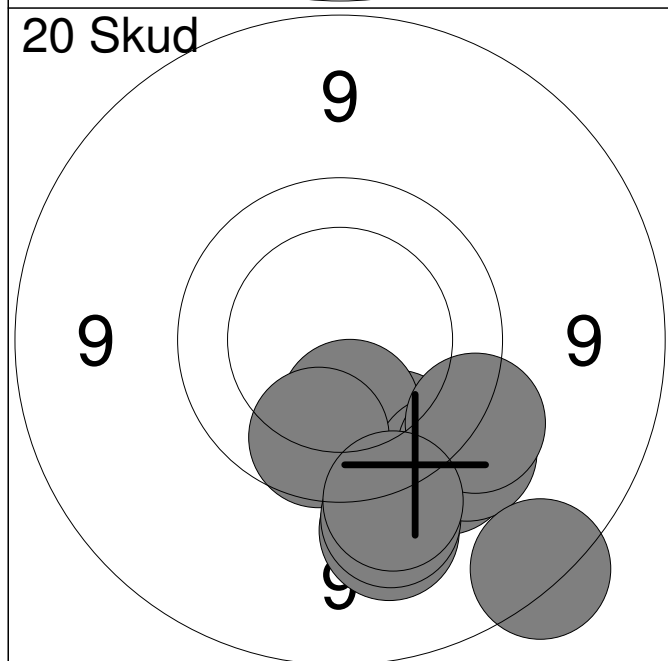

11:	9.3	↓
12:	9.8	↓
13:	10.2	↓
14:	9.5	↓
15:	9.9	↙
16:	9.4	↙
17:	9.5	↙
18:	9.5	↙
19:	8.8	↙
20:	9.5	↙
Serie		90.0
Total		185.0

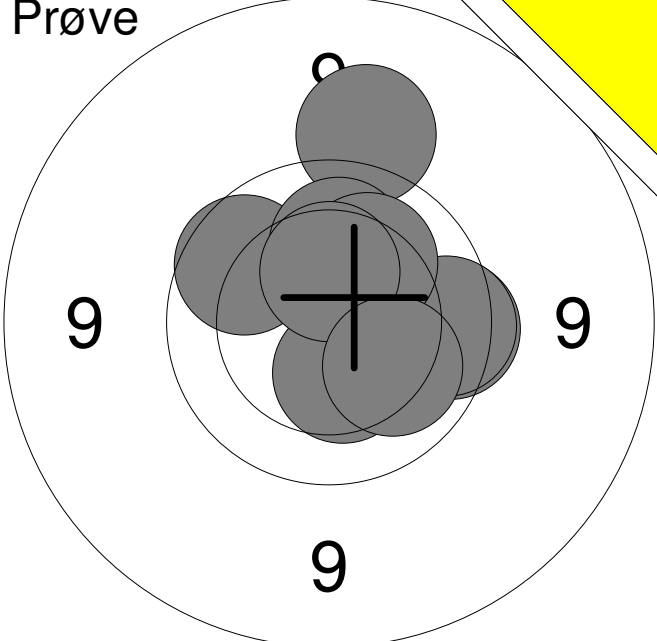
Prøve 	1:	9.9	↗
	2:	9.3	↑
	3:	10.4	↗
	4:	9.8	→
	5:	9.8	→
	6:	10.4	↓
	7:	10.1	↑
	8:	10.2	↗
	9:	10.4	↑
	10:	10.1	↘
	Serie		96.0
Total		0.0	

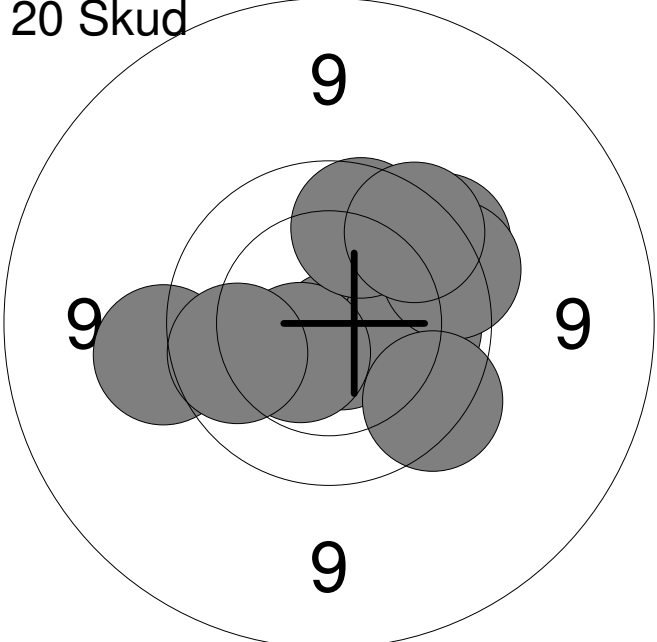
20 Skud 	1:	10.7x	↘
	2:	10.1	→
	3:	10.5x	↙
	4:	9.7	↗
	5:	9.9	↑
	6:	9.7	→
	7:	9.5	←
	8:	9.8	↗
	9:	9.7	↘
	10:	9.9	←
	Serie		93.0
Total		93.0	

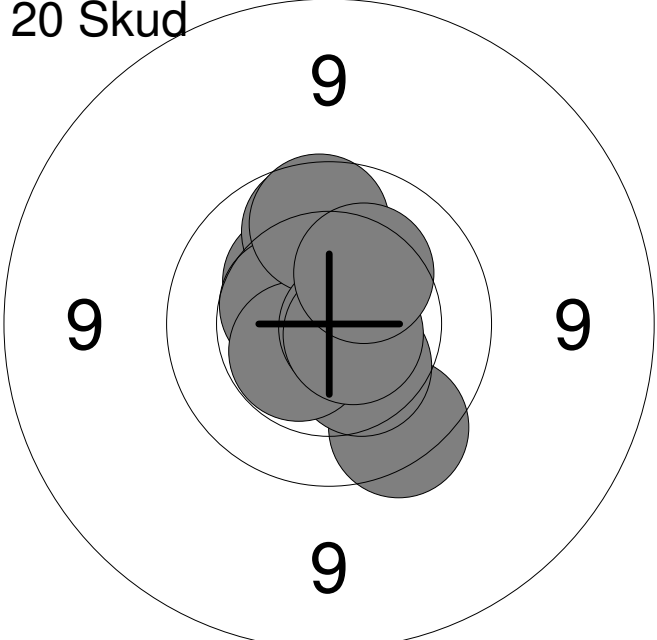
20 Skud 	11:	10.3	↗
	12:	9.9	↑
	13:	10.5	↗
	14:	9.8	↘
	15:	10.4	↘
	16:	10.5x	↙
	17:	9.9	↑
	18:	10.7x	→
	19:	10.7x	↘
	20:	10.3	↗
	Serie		97.0
Total		190.0	

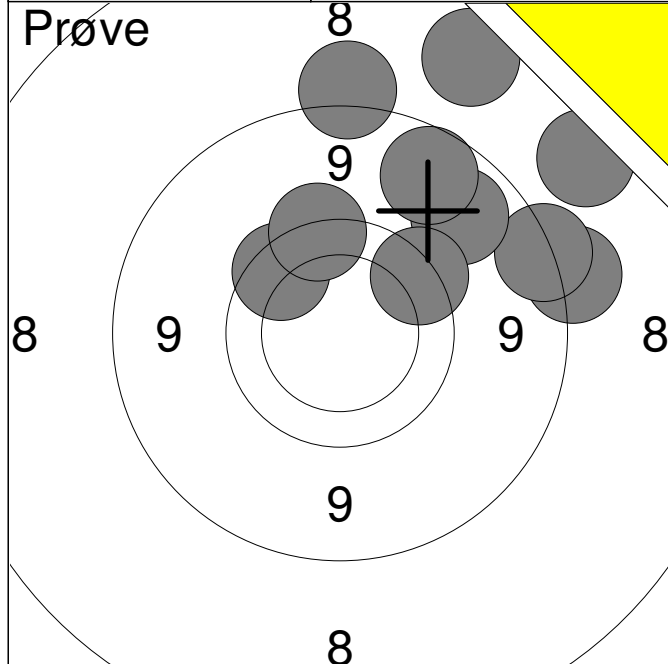

1:	9.8	↖
2:	9.6	↑
3:	8.2	↗
4:	8.6	→
5:	8.2	↗
6:	8.6	↑
7:	8.7	→
8:	9.0	↗
9:	9.7	↗
10:	8.9	↗

Serie	84.0
Total	0.0

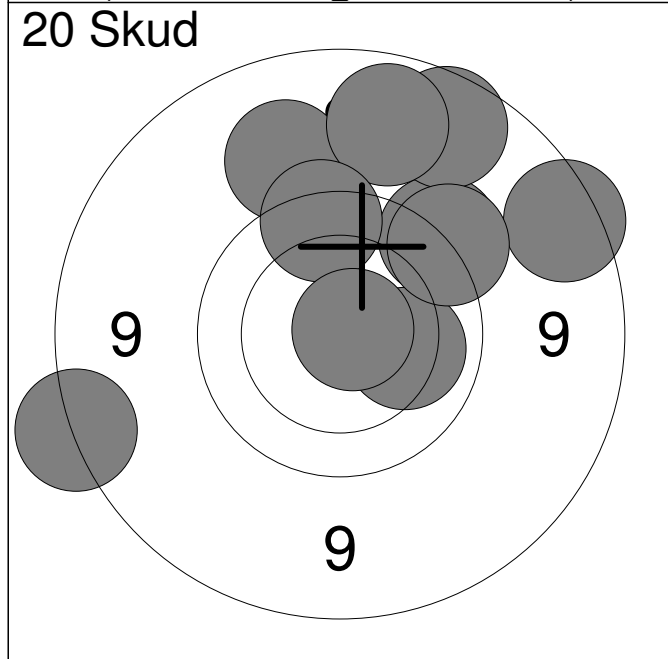

1:	8.8	↗
2:	9.5	↗
3:	8.9	↗
4:	8.7	←
5:	9.2	↑
6:	10.1	→
7:	9.0	↑
8:	9.5	↗
9:	9.7	↑
10:	10.8x	→

Serie	89.0
Total	89.0

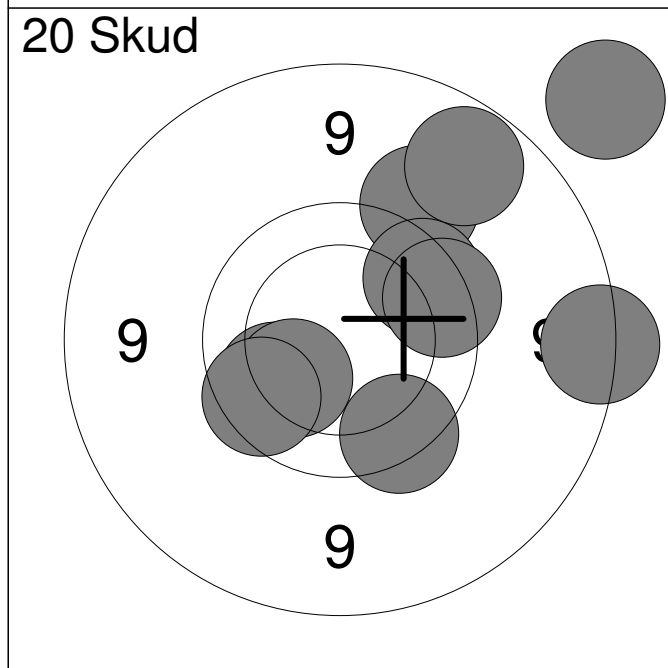

11:	9.4	↗
12:	10.0	↖
13:	9.8	↗
14:	10.2	↖
15:	8.7	→
16:	9.7	↗
17:	9.7	↘
18:	8.3	↗
19:	9.8	↖
20:	9.0	↗

Serie	90.0
Total	179.0

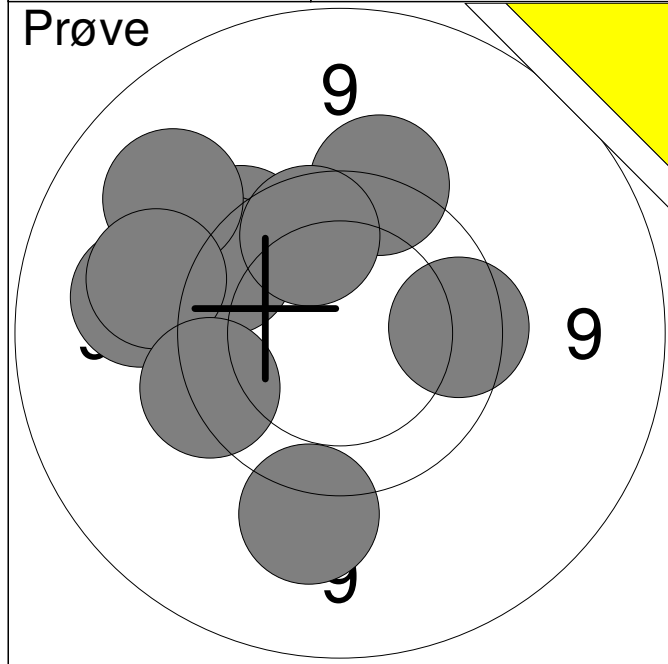

1:	9.4	↓
2:	9.7	↗
3:	9.3	←
4:	9.7	↗
5:	9.2	↗
6:	9.3	←
7:	9.6	↑
8:	9.7	←
9:	9.8	→
10:	9.9	↑
Serie		90.0
Total		0.0

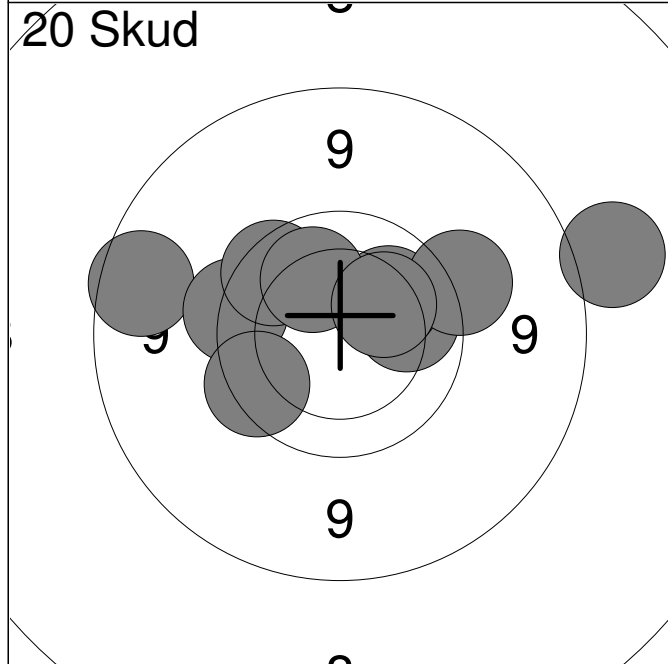

1:	8.9	←
2:	10.0	→
3:	9.7	←
4:	10.1	↗
5:	9.8	↗
6:	9.5	→
7:	10.1	↑
8:	9.7	←
9:	10.2	↗
10:	8.5	→
Serie		92.0
Total		92.0

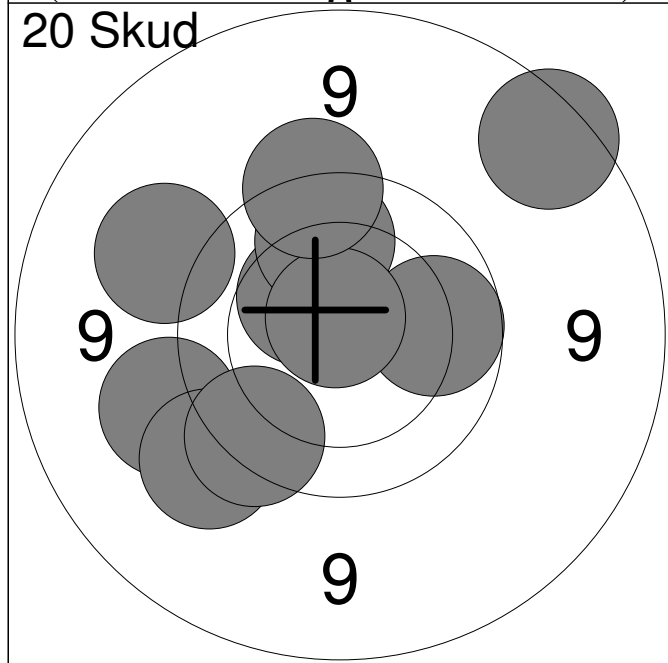

11:	9.4	←
12:	9.9	→
13:	9.3	←
14:	10.4	↗
15:	9.9	↑
16:	10.8x	↑
17:	9.4	←
18:	8.8	↗
19:	9.7	←
20:	9.6	↑
Serie		91.0
Total		183.0

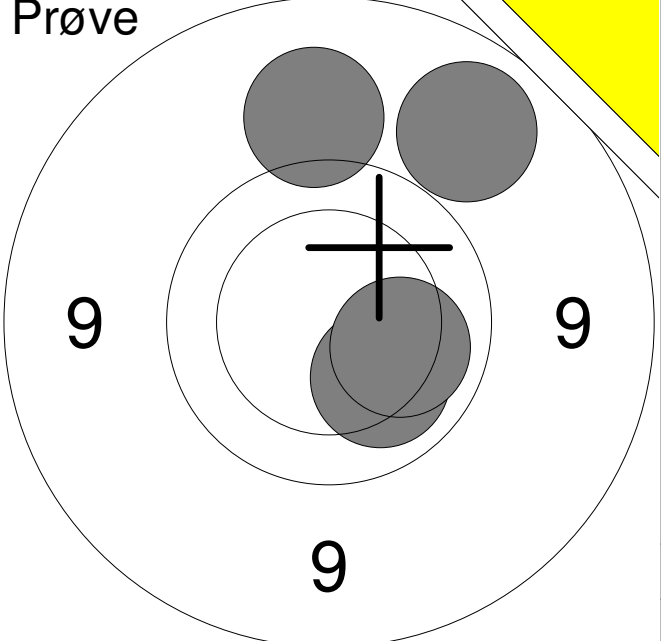
<p>Prøve</p> 	<table style="width:100%; border-collapse: collapse;"> <tr><td style="width:10%;">1:</td><td style="width:15%;">10.1</td><td style="width:10%; text-align: right;">↘</td></tr> <tr><td>2:</td><td>10.1</td><td style="text-align: right;">→</td></tr> <tr><td>3:</td><td>9.3</td><td style="text-align: right;">↑</td></tr> <tr><td>4:</td><td>9.1</td><td style="text-align: right;">↗</td></tr> </table>	1:	10.1	↘	2:	10.1	→	3:	9.3	↑	4:	9.1	↗
1:	10.1	↘											
2:	10.1	→											
3:	9.3	↑											
4:	9.1	↗											
<table style="width:100%; border-collapse: collapse;"> <tr> <td style="width:10%;">Serie</td> <td style="width:15%;"></td> <td style="width:10%; text-align: right;">38.0</td> </tr> <tr> <td>Total</td> <td></td> <td style="text-align: right;">0.0</td> </tr> </table>		Serie		38.0	Total		0.0						
Serie		38.0											
Total		0.0											

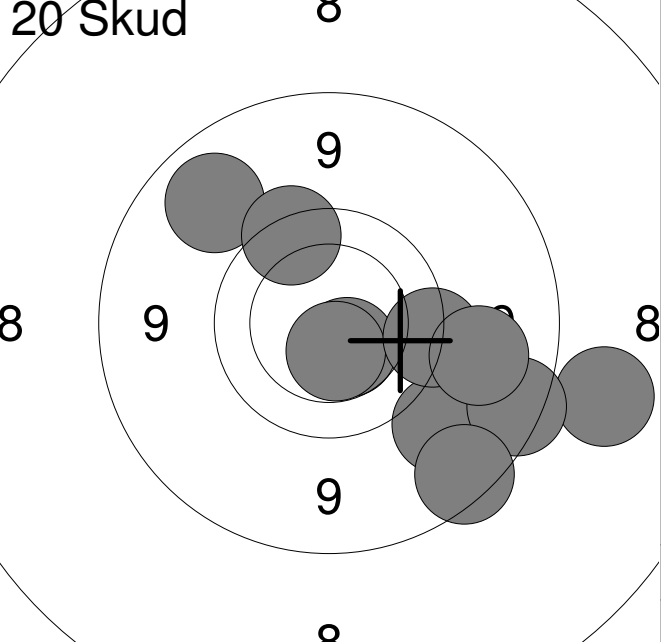
<p>20 Skud</p> 	<table style="width:100%; border-collapse: collapse;"> <tr><td style="width:10%;">1:</td><td style="width:15%;">9.2</td><td style="width:10%; text-align: right;">↘</td></tr> <tr><td>2:</td><td>8.4</td><td style="text-align: right;">→</td></tr> <tr><td>3:</td><td>8.8</td><td style="text-align: right;">↘</td></tr> <tr><td>4:</td><td>8.8</td><td style="text-align: right;">↘</td></tr> <tr><td>5:</td><td>10.5</td><td style="text-align: right;">↘</td></tr> <tr><td>6:</td><td>9.1</td><td style="text-align: right;">↗</td></tr> <tr><td>7:</td><td>10.5x</td><td style="text-align: right;">↘</td></tr> <tr><td>8:</td><td>9.6</td><td style="text-align: right;">→</td></tr> <tr><td>9:</td><td>9.7</td><td style="text-align: right;">↗</td></tr> <tr><td>10:</td><td>9.2</td><td style="text-align: right;">→</td></tr> </table>	1:	9.2	↘	2:	8.4	→	3:	8.8	↘	4:	8.8	↘	5:	10.5	↘	6:	9.1	↗	7:	10.5x	↘	8:	9.6	→	9:	9.7	↗	10:	9.2	→
1:	9.2	↘																													
2:	8.4	→																													
3:	8.8	↘																													
4:	8.8	↘																													
5:	10.5	↘																													
6:	9.1	↗																													
7:	10.5x	↘																													
8:	9.6	→																													
9:	9.7	↗																													
10:	9.2	→																													
<table style="width:100%; border-collapse: collapse;"> <tr> <td style="width:10%;">Serie</td> <td style="width:15%;"></td> <td style="width:10%; text-align: right;">89.0</td> </tr> <tr> <td>Total</td> <td></td> <td style="text-align: right;">89.0</td> </tr> </table>		Serie		89.0	Total		89.0																								
Serie		89.0																													
Total		89.0																													

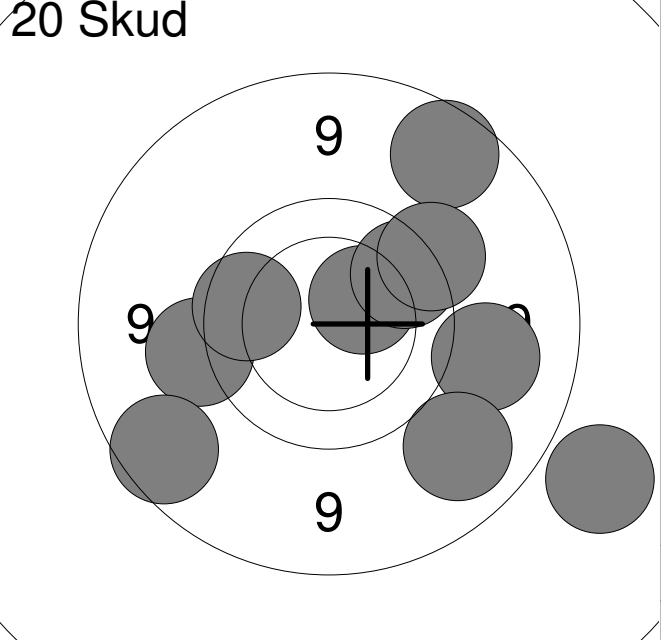
<p>20 Skud</p> 	<table style="width:100%; border-collapse: collapse;"> <tr><td style="width:10%;">11:</td><td style="width:15%;">10.4</td><td style="width:10%; text-align: right;">↗</td></tr> <tr><td>12:</td><td>9.8</td><td style="text-align: right;">↗</td></tr> <tr><td>13:</td><td>9.5</td><td style="text-align: right;">←</td></tr> <tr><td>14:</td><td>9.2</td><td style="text-align: right;">→</td></tr> <tr><td>15:</td><td>9.8</td><td style="text-align: right;">←</td></tr> <tr><td>16:</td><td>8.9</td><td style="text-align: right;">↗</td></tr> <tr><td>17:</td><td>9.5</td><td style="text-align: right;">↗</td></tr> <tr><td>18:</td><td>8.4</td><td style="text-align: right;">↘</td></tr> <tr><td>19:</td><td>9.1</td><td style="text-align: right;">↘</td></tr> <tr><td>20:</td><td>8.9</td><td style="text-align: right;">↙</td></tr> </table>	11:	10.4	↗	12:	9.8	↗	13:	9.5	←	14:	9.2	→	15:	9.8	←	16:	8.9	↗	17:	9.5	↗	18:	8.4	↘	19:	9.1	↘	20:	8.9	↙
11:	10.4	↗																													
12:	9.8	↗																													
13:	9.5	←																													
14:	9.2	→																													
15:	9.8	←																													
16:	8.9	↗																													
17:	9.5	↗																													
18:	8.4	↘																													
19:	9.1	↘																													
20:	8.9	↙																													
<table style="width:100%; border-collapse: collapse;"> <tr> <td style="width:10%;">Serie</td> <td style="width:15%;"></td> <td style="width:10%; text-align: right;">88.0</td> </tr> <tr> <td>Total</td> <td></td> <td style="text-align: right;">177.0</td> </tr> </table>		Serie		88.0	Total		177.0																								
Serie		88.0																													
Total		177.0																													

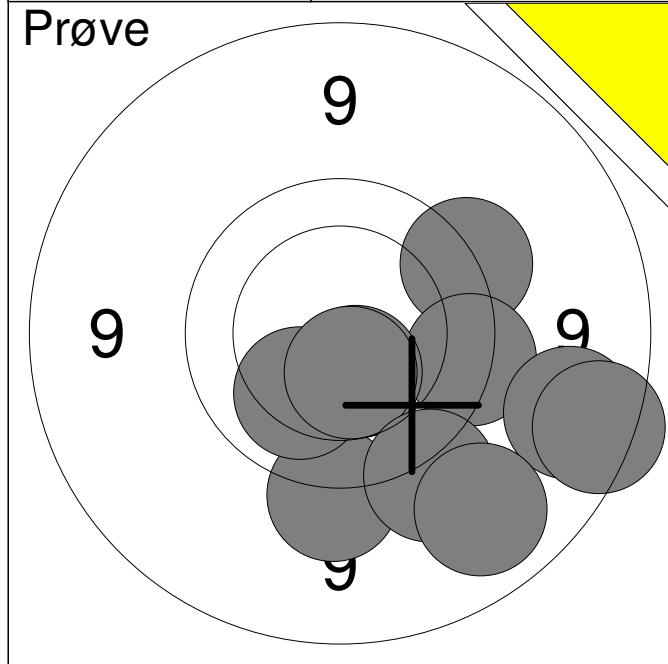

1:	9.5	↓
2:	9.6	→
3:	9.7	→
4:	10.1	↓
5:	10.5	↓
6:	10.5x	↓
7:	9.0	→
8:	8.8	→
9:	9.4	↓
10:	9.1	↓
Serie		92.0
Total		0.0

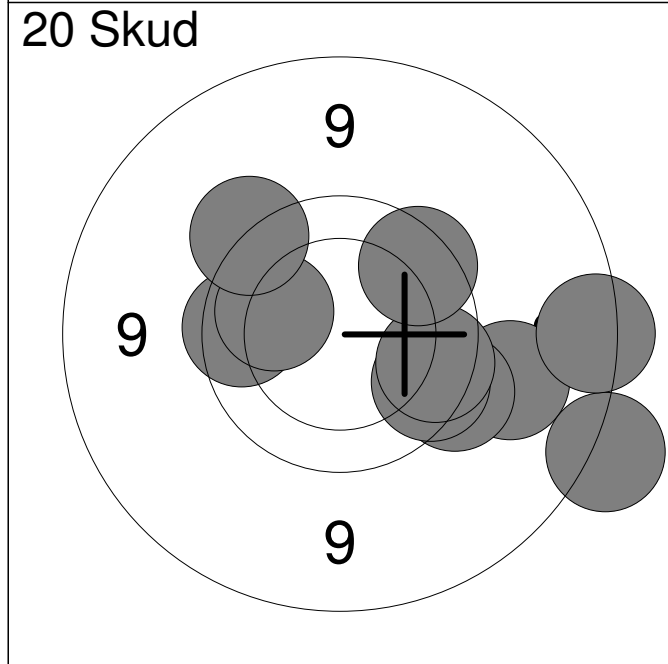

1:	9.2	→
2:	8.6	↓
3:	8.8	→
4:	9.6	↓
5:	9.8	↓
6:	9.8	←
7:	10.1	↑
8:	9.8	→
9:	9.8	→
10:	9.6	↑
Serie		89.0
Total		89.0

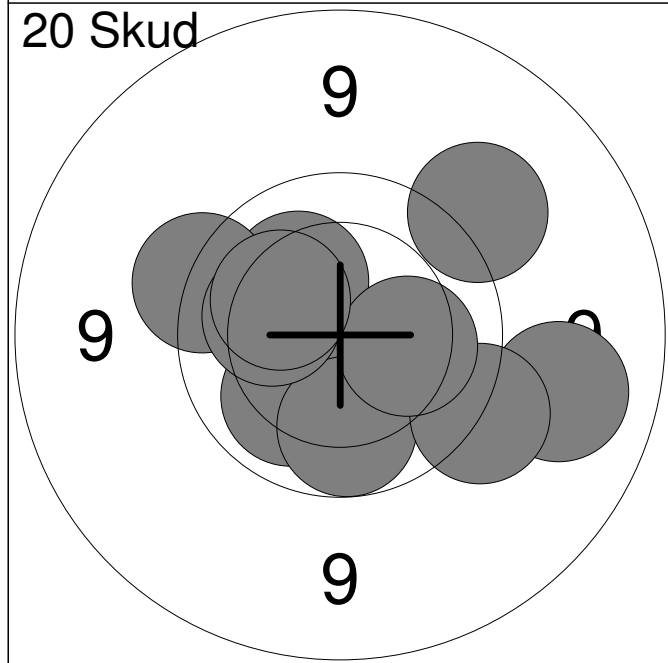

11:	10.1	↙
12:	10.2	↗
13:	9.1	→
14:	10.0	↓
15:	9.5	↓
16:	9.6	↑
17:	10.2	→
18:	10.2	↑
19:	10.2	↗
20:	9.4	↗
Serie		96.0
Total		185.0

Hold 73	Skive 8	Kåre L. Nielsen
-------------------	-------------------	------------------------

15m	Mou & Omegns Skf.	ÅK3
-----	-------------------	-----

24.10.2013	15 meter riffelstævne 2013	Aalborg Skyttekreds
------------	----------------------------	---------------------

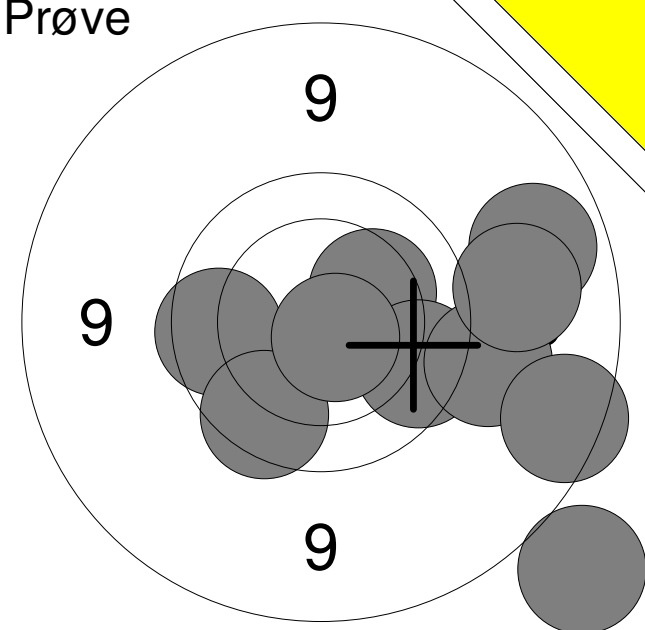
Prøve 	1:	8.4	↘
	2:	10.3	→
	3:	9.0	→
	4:	9.8	↘
	5:	9.8	←
	6:	9.8	↘
	7:	10.7x	↘
	8:	9.4	→
	9:	8.8	↘
	10:	9.2	→
	Serie		90.0
Total		0.0	

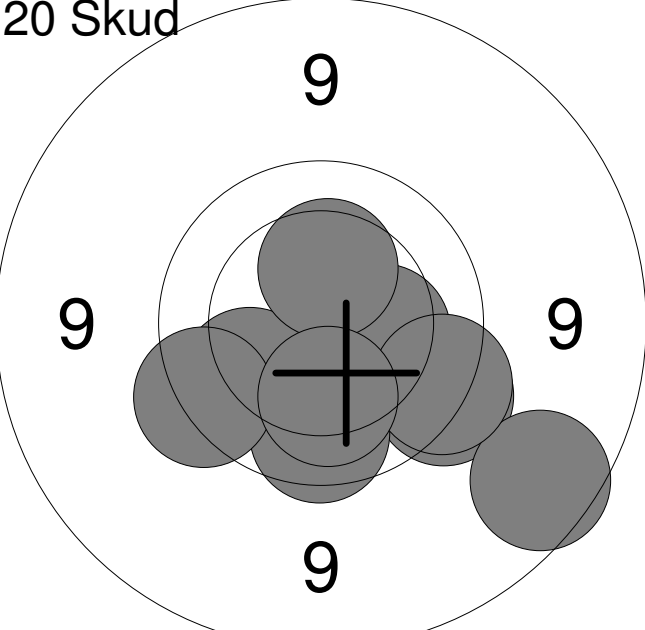
20 Skud 	1:	10.3	↓
	2:	10.3	→
	3:	9.6	↘
	4:	10.0	←
	5:	8.9	↘
	6:	9.8	↓
	7:	9.7	→
	8:	9.7	←
	9:	10.4	↑
	10:	10.2	↓
	Serie		94.0
Total		94.0	

20 Skud 	11:	10.0	→
	12:	10.5	↘
	13:	10.3	↘
	14:	9.6	↘
	15:	9.5	↘
	16:	10.7x	↘
	17:	10.5	↗
	18:	9.6	↘
	19:	9.5	↘
	20:	9.2	↘
	Serie		95.0
Total		189.0	

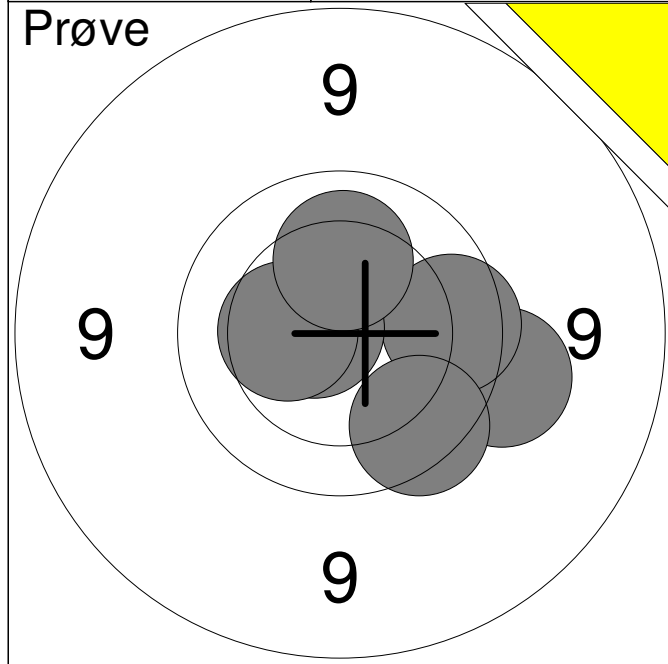

1:	9.5	→
2:	9.8	→
3:	10.7x	←
4:	9.8	↓
5:	10.4	←
6:	10.2	↑
Serie		57.0
Total		0.0

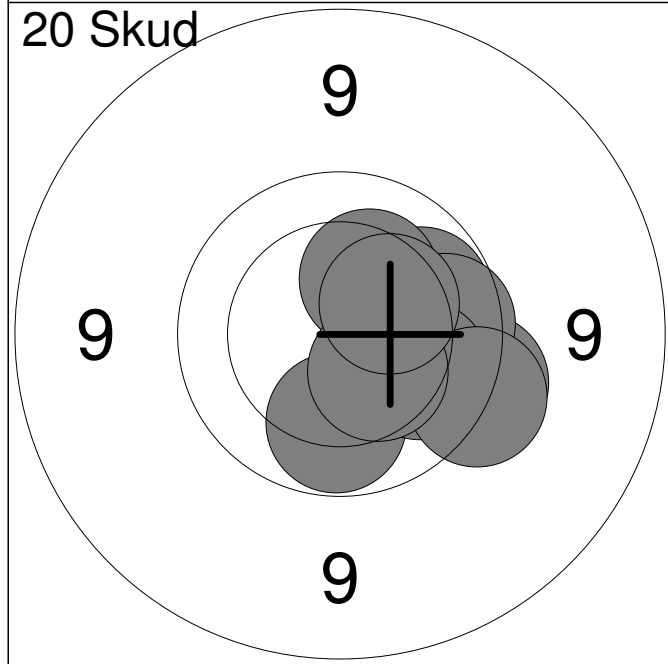

1:	9.6	→
2:	10.0	↓
3:	10.0	→
4:	10.4	↘
5:	9.9	→
6:	10.0	↘
7:	10.3	↗
8:	9.6	↘
9:	10.4	↓
10:	10.3	↗
Serie		97.0
Total		97.0

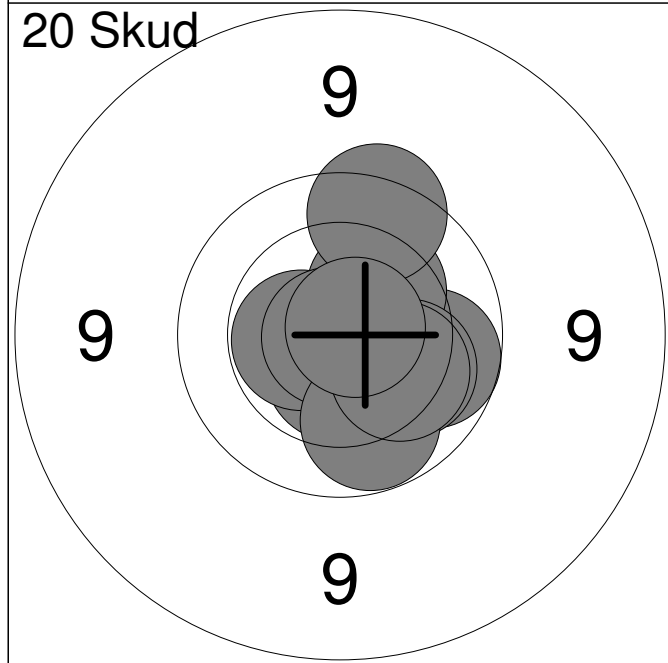

11:	9.9	→
12:	10.3	↗
13:	10.6x	↓
14:	9.7	↑
15:	10.5x	←
16:	10.9x	←
17:	10.1	↘
18:	10.0	↓
19:	10.2	↘
20:	10.8x	↗
Serie		98.0
Total		195.0

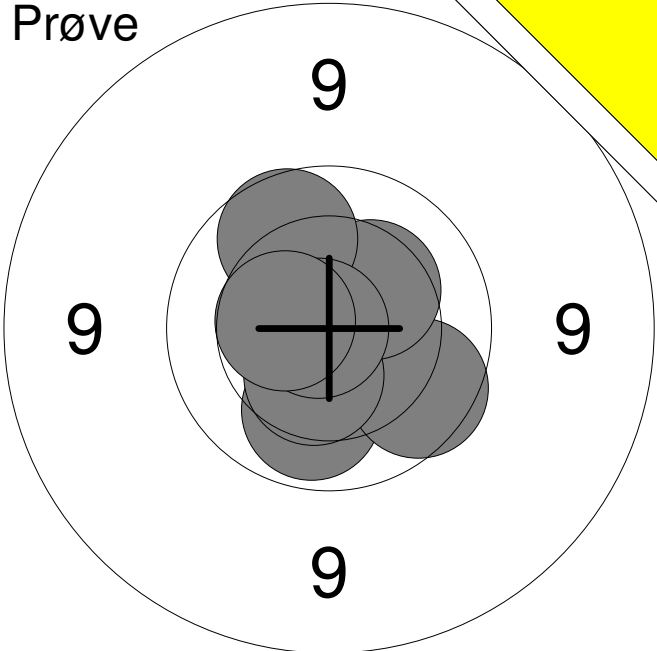
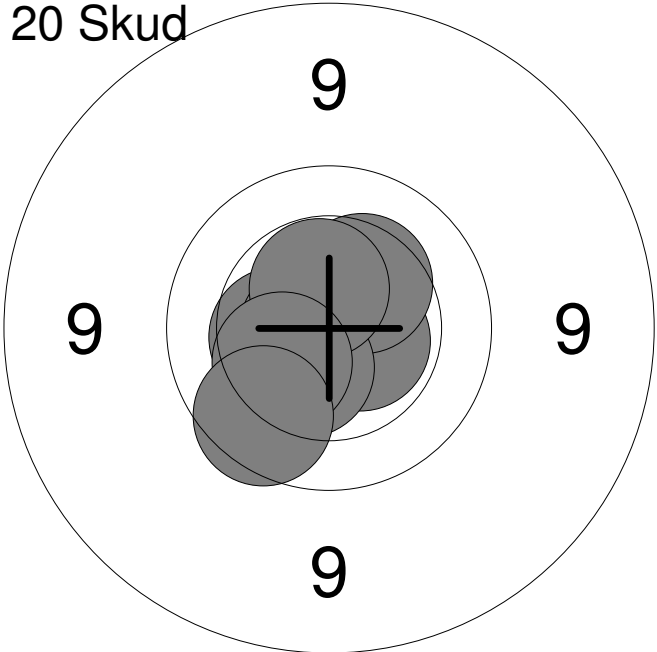
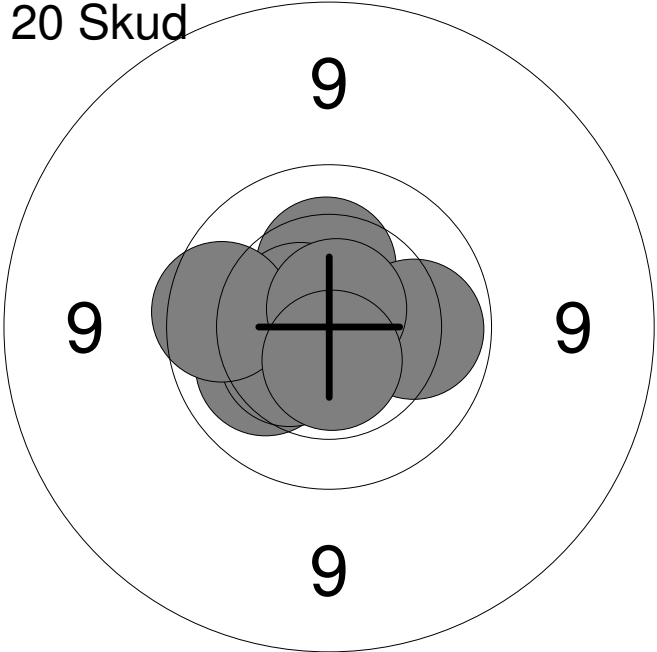
Hold	Skive	Nicki R. M. Jensen	
73	10	Hobro Egnens Skytteforening	BK1
24.10.2013	15 meter riffelstævne 2013	Aalborg Skyttekreds	
Prøve		1: 10.0	↓
		2: 9.9	→
		3: 10.4	↓
		4: 10.3	↗
		5: 9.9	↖
		6: 10.8x	←
		7: 10.5	←
		Serie	68.0
		Total	0.0
20 Skud		1: 10.4	↙
		2: 10.4	←
		3: 10.8x	↙
		4: 10.7x	←
		5: 10.6x	→
		6: 10.3	↗
		7: 10.4	↙
		8: 10.5x	↖
		9: 10.3	↙
		10: 9.8	↙
		Serie	99.0
		Total	99.0
20 Skud		11: 10.7x	←
		12: 10.3	↑
		13: 10.2	↙
		14: 10.7x	→
		15: 10.6x	↖
		16: 10.4	↙
		17: 10.0	→
		18: 9.9	←
		19: 10.7x	↖
		20: 10.6x	↓
		Serie	99.0
		Total	198.0

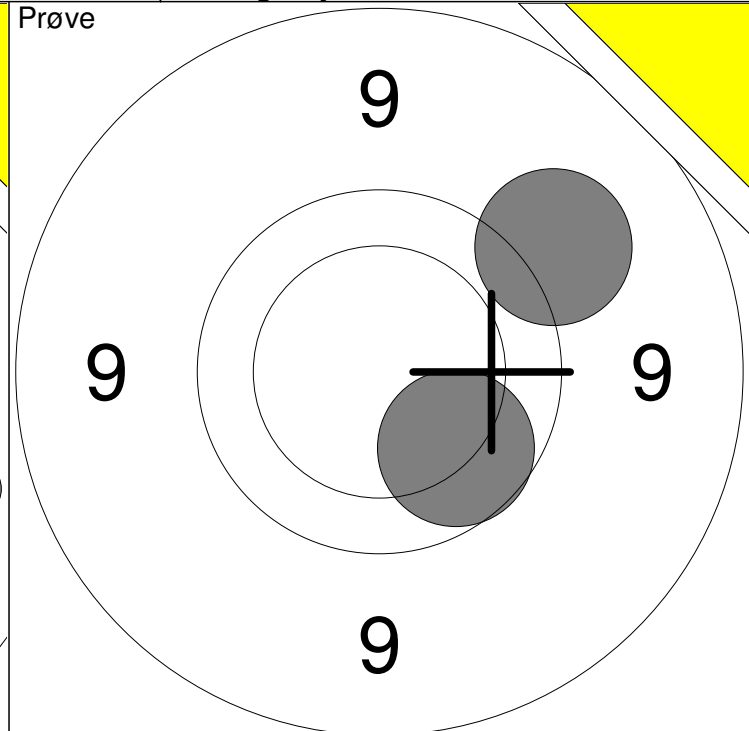
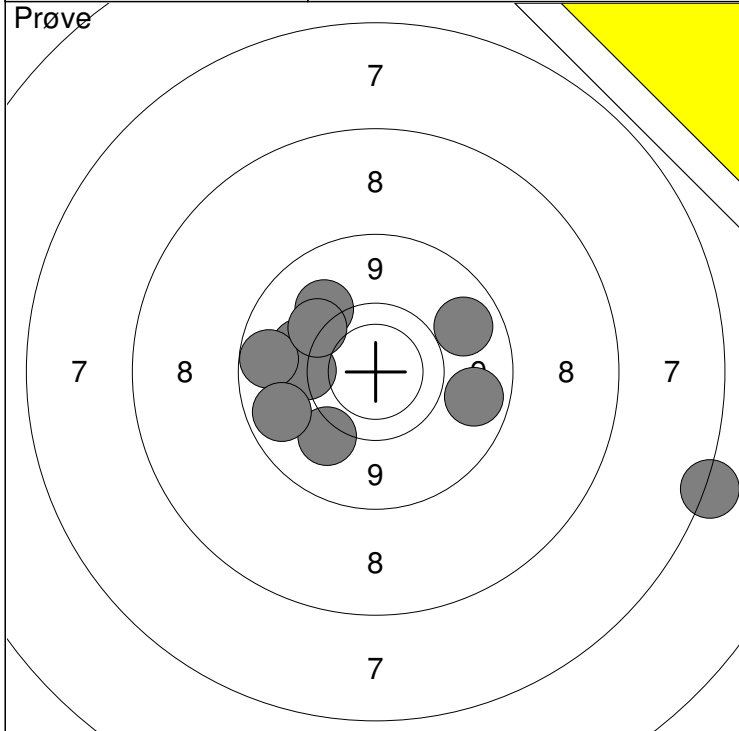

1: 9.4 ↙	6: 9.0 ←	Serie	87
2: 9.4 ←	7: 9.5 ↗		
3: 9.1 →	8: 9.1 →	Total	0
4: 9.3 ↗	9: 6.6 ↘		
5: 9.5 ←	10: 9.0 ←		

11: 9.9 ↘	Serie	18
12: 9.3 ↗		
Total		0

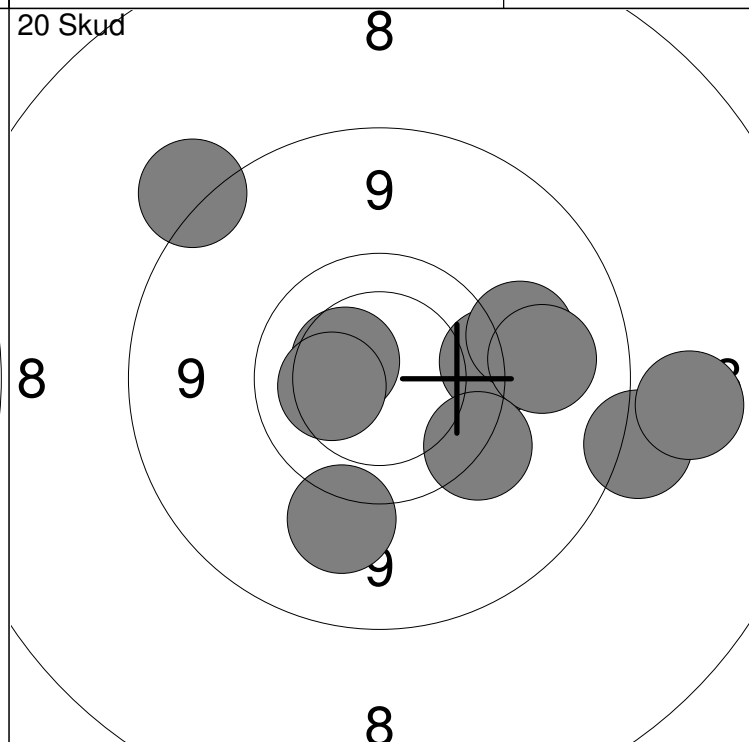
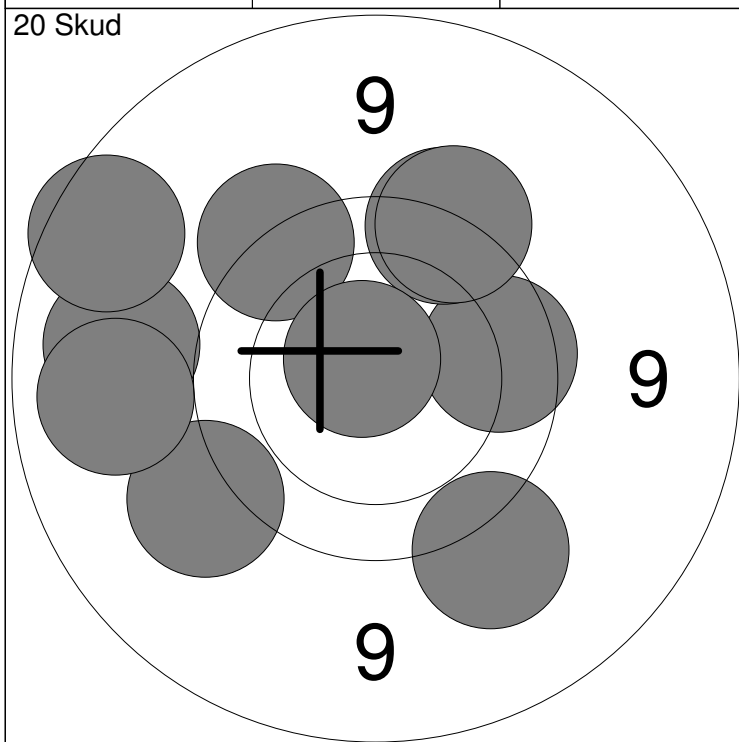

1: 9.8 →	6: 9.6 ↗	Serie	90
2: 9.4 ↙	7: 9.1 ←		
3: 9.4 ↘	8: 9.6 ↗	Total	90
4: 9.1 ←	9: 8.9 ↖		
5: 9.6 ↗	10: 10.7x ↗		

11: 9.6 →	16: 9.4 ↘	Serie	89
12: 9.3 →	17: 8.6 ↗		
13: 9.2 →	18: 10.3 ←	Total	179
14: 8.6 ↘	19: 9.6 ↘		
15: 10.4 ↖	20: 8.4 →		

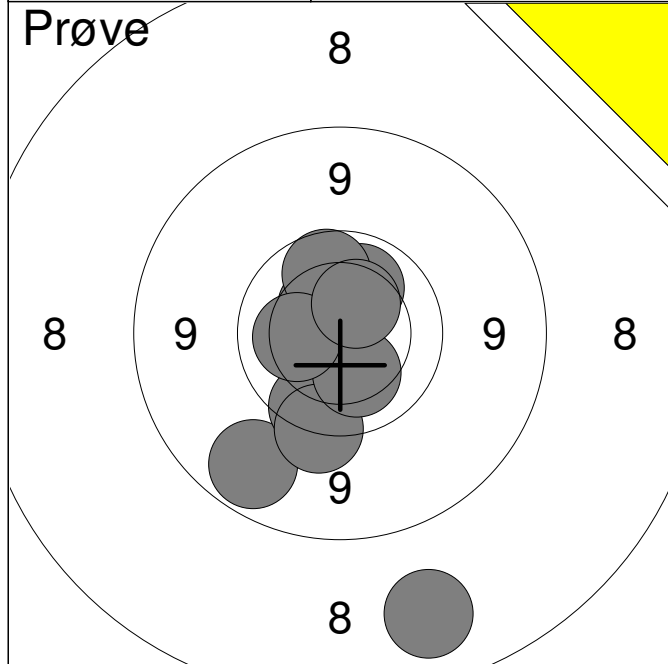

1:	8.1	↓
2:	9.0	↙
3:	9.8	↓
4:	10.1	↗
5:	9.6	↓
6:	10.4	↗
7:	10.2	↓
8:	9.9	↗
9:	10.2	←
10:	10.4	↗

Serie	94.0
Total	0.0

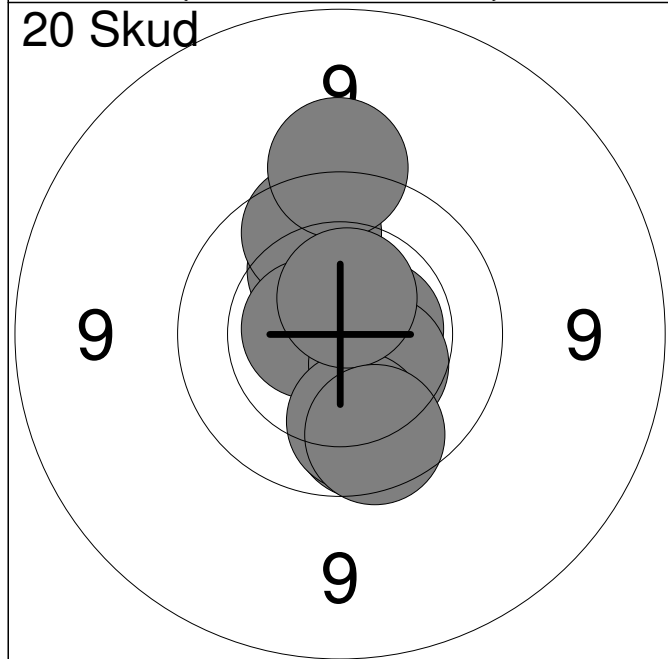

1:	10.2	↗
2:	9.9	↓
3:	10.6x	→
4:	9.9	↗
5:	10.6x	←
6:	9.5	↑
7:	10.4	↓
8:	10.0	↓
9:	10.6x	↑
10:	9.9	↓

Serie	96.0
Total	96.0

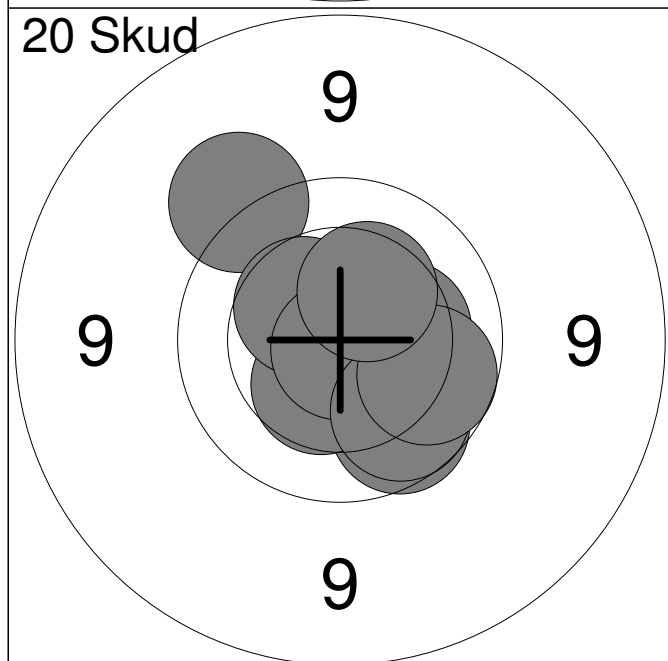

11:	10.3	↓
12:	9.9	↓
13:	9.5	↗
14:	10.4	↓
15:	10.3	→
16:	10.4	↗
17:	10.8x	↓
18:	9.9	↓
19:	9.9	↘
20:	10.4	↗

Serie	96.0
Total	192.0

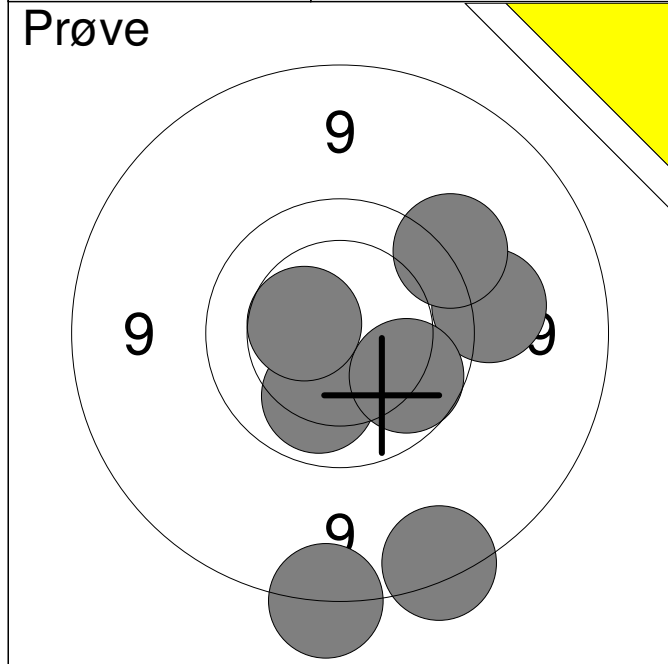

1:	8.7	↓
2:	10.1	↓
3:	9.4	→
4:	9.5	↗
5:	9.9	↘
6:	8.8	↓
7:	10.5	↖

Serie	63.0
Total	0.0

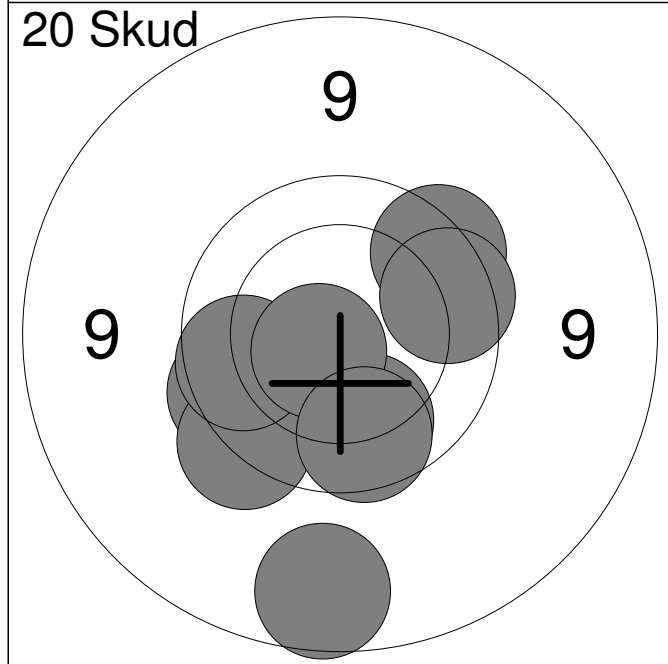

1:	10.0	↓
2:	8.9	↓
3:	10.1	↙
4:	9.8	↖
5:	9.6	↙
6:	9.9	↖
7:	10.6x	↙
8:	9.9	↓
9:	9.7	↗
10:	9.8	→

Serie	92.0
Total	92.0

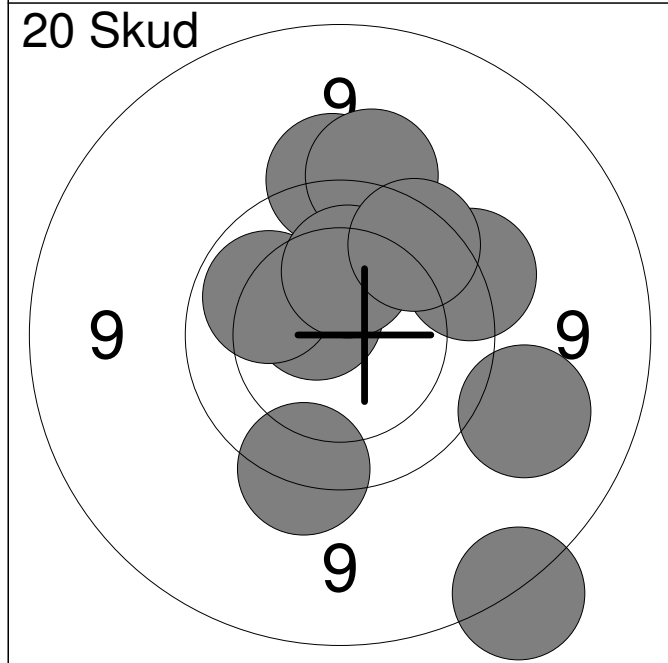

11:	10.6x	↖
12:	9.5	↑
13:	10.0	↖
14:	9.5	↑
15:	8.7	↓
16:	9.6	↗
17:	9.2	↗
18:	9.6	↓
19:	10.2	↑
20:	9.8	↗

Serie	92.0
Total	184.0

Hold 74	Skive 2	Lars Jakobsen	
-------------------	-------------------	----------------------	--

15m	Vilsted Skf.	ÅK1	
-----	--------------	-----	--

24.10.2013	15 meter riffelstævne 2013	Aalborg Skyttekreds	
------------	----------------------------	---------------------	--

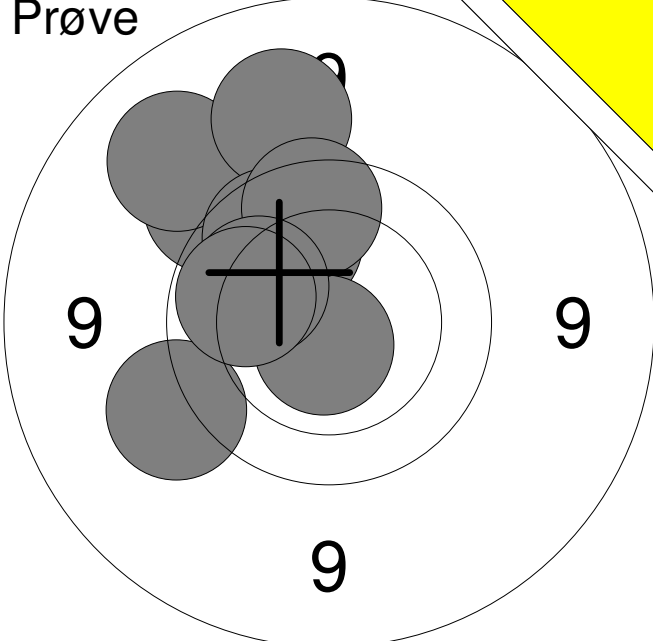
Prøve 	1:	9.4	↖
	2:	9.5	↗
	3:	9.2	↗
	4:	10.0	↗
	5:	9.2	↗
	6:	9.9	↗
	7:	10.7x	↘
	8:	9.8	↗
	9:	10.1	↗
	10:	10.0	↖
	Serie		94.0
Total		0.0	

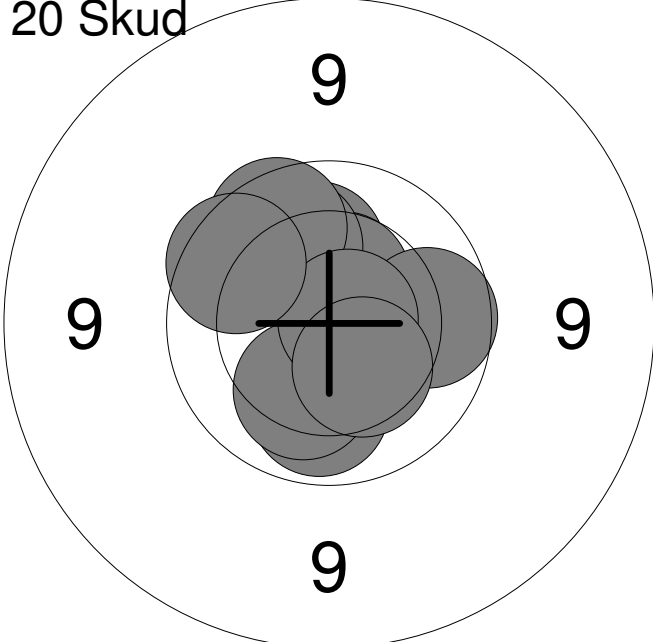
20 Skud 	1:	10.0	↘
	2:	10.2	↗
	3:	10.5	↗
	4:	10.0	↗
	5:	9.9	→
	6:	9.9	↗
	7:	10.2	↘
	8:	10.7x	→
	9:	9.8	↗
	10:	10.4	↘
	Serie		97.0
Total		97.0	

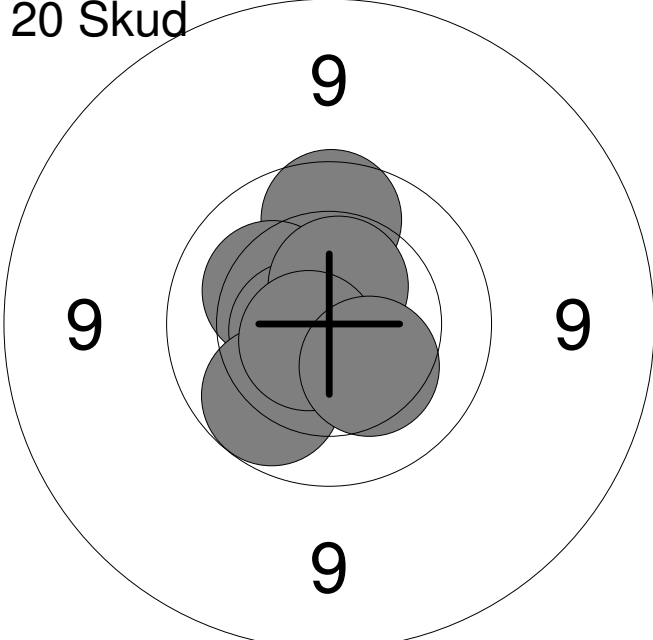
20 Skud 	11:	10.6x	↘
	12:	9.9	↗
	13:	10.2	↗
	14:	10.6x	↘
	15:	10.9x	↘
	16:	10.6x	↖
	17:	10.5x	↗
	18:	10.0	↘
	19:	10.7x	↘
	20:	10.3	↘
	Serie		99.0
Total		196.0	

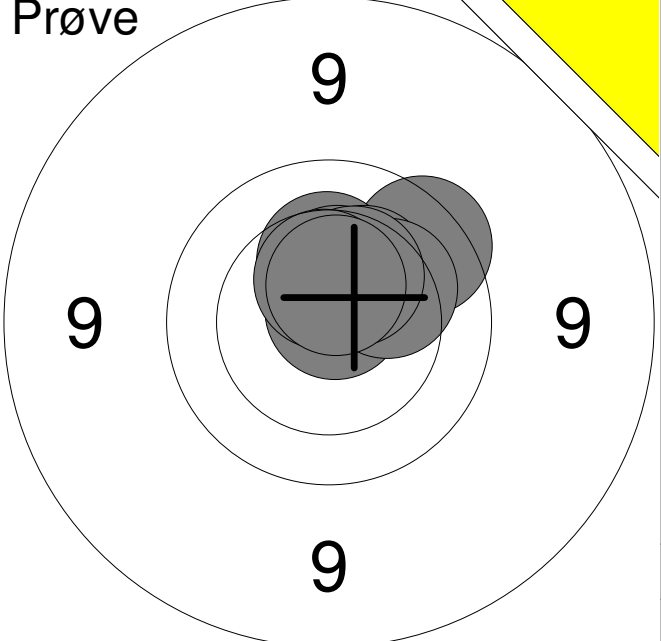
<p>Prøve</p> 	<table style="width:100%; border-collapse: collapse;"> <tr><td style="width:5%;">1:</td><td style="width:15%;">9.8</td><td style="width:10%; text-align: right;">↗</td></tr> <tr><td>2:</td><td>10.3</td><td style="text-align: right;">↑</td></tr> <tr><td>3:</td><td>10.4</td><td style="text-align: right;">↑</td></tr> <tr><td>4:</td><td>10.8x</td><td style="text-align: right;">↑</td></tr> <tr><td>5:</td><td>10.3</td><td style="text-align: right;">↗</td></tr> <tr><td>6:</td><td>10.2</td><td style="text-align: right;">↗</td></tr> <tr><td>7:</td><td>10.4</td><td style="text-align: right;">↗</td></tr> <tr><td>8:</td><td>10.5</td><td style="text-align: right;">↑</td></tr> <tr><td>9:</td><td>10.5x</td><td style="text-align: right;">↑</td></tr> <tr><td colspan="2">Serie</td><td style="text-align: right;">89.0</td></tr> <tr><td colspan="2">Total</td><td style="text-align: right;">0.0</td></tr> </table>	1:	9.8	↗	2:	10.3	↑	3:	10.4	↑	4:	10.8x	↑	5:	10.3	↗	6:	10.2	↗	7:	10.4	↗	8:	10.5	↑	9:	10.5x	↑	Serie		89.0	Total		0.0
1:	9.8	↗																																
2:	10.3	↑																																
3:	10.4	↑																																
4:	10.8x	↑																																
5:	10.3	↗																																
6:	10.2	↗																																
7:	10.4	↗																																
8:	10.5	↑																																
9:	10.5x	↑																																
Serie		89.0																																
Total		0.0																																

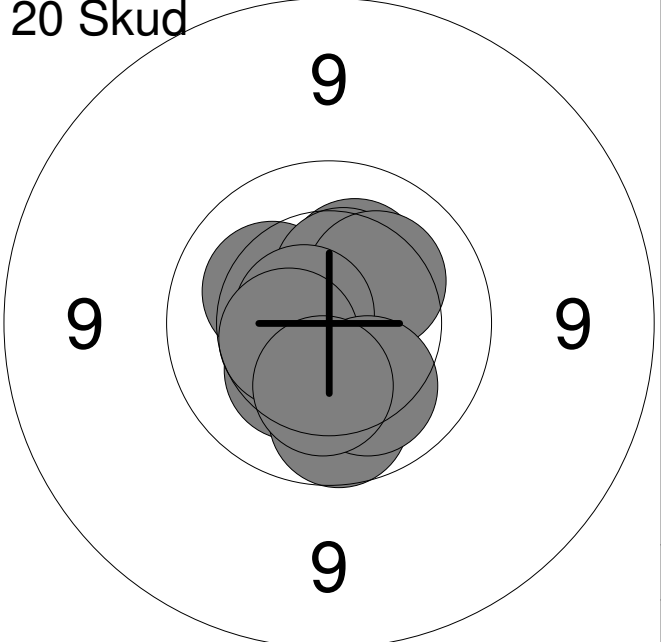
<p>20 Skud</p> 	<table style="width:100%; border-collapse: collapse;"> <tr><td style="width:5%;">1:</td><td style="width:15%;">10.3</td><td style="width:10%; text-align: right;">↖</td></tr> <tr><td>2:</td><td>10.3</td><td style="text-align: right;">↑</td></tr> <tr><td>3:</td><td>10.4</td><td style="text-align: right;">↑</td></tr> <tr><td>4:</td><td>10.3</td><td style="text-align: right;">↗</td></tr> <tr><td>5:</td><td>10.3</td><td style="text-align: right;">↙</td></tr> <tr><td>6:</td><td>10.7x</td><td style="text-align: right;">↖</td></tr> <tr><td>7:</td><td>10.5</td><td style="text-align: right;">↖</td></tr> <tr><td>8:</td><td>9.9</td><td style="text-align: right;">↓</td></tr> <tr><td>9:</td><td>10.2</td><td style="text-align: right;">↓</td></tr> <tr><td>10:</td><td>10.3</td><td style="text-align: right;">↓</td></tr> <tr><td colspan="2">Serie</td><td style="text-align: right;">99.0</td></tr> <tr><td colspan="2">Total</td><td style="text-align: right;">99.0</td></tr> </table>	1:	10.3	↖	2:	10.3	↑	3:	10.4	↑	4:	10.3	↗	5:	10.3	↙	6:	10.7x	↖	7:	10.5	↖	8:	9.9	↓	9:	10.2	↓	10:	10.3	↓	Serie		99.0	Total		99.0
1:	10.3	↖																																			
2:	10.3	↑																																			
3:	10.4	↑																																			
4:	10.3	↗																																			
5:	10.3	↙																																			
6:	10.7x	↖																																			
7:	10.5	↖																																			
8:	9.9	↓																																			
9:	10.2	↓																																			
10:	10.3	↓																																			
Serie		99.0																																			
Total		99.0																																			

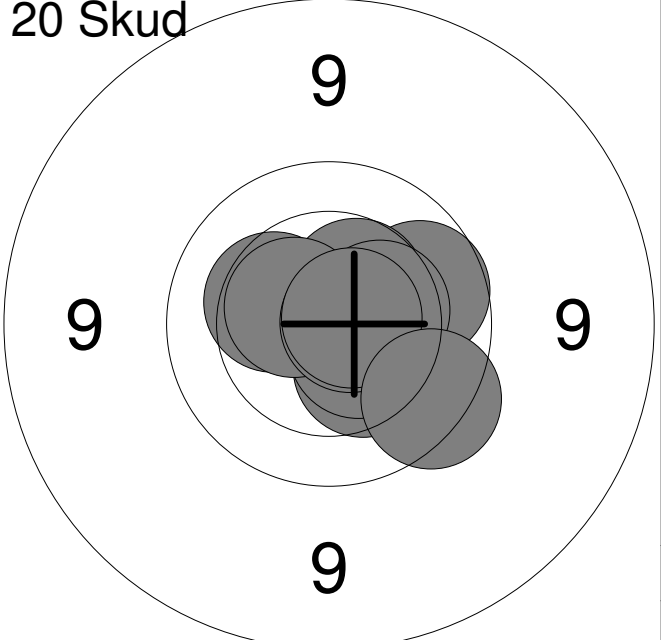
<p>20 Skud</p> 	<table style="width:100%; border-collapse: collapse;"> <tr><td style="width:5%;">11:</td><td style="width:15%;">9.9</td><td style="width:10%; text-align: right;">→</td></tr> <tr><td>12:</td><td>10.5</td><td style="text-align: right;">↗</td></tr> <tr><td>13:</td><td>10.4</td><td style="text-align: right;">↘</td></tr> <tr><td>14:</td><td>10.5x</td><td style="text-align: right;">↘</td></tr> <tr><td>15:</td><td>10.3</td><td style="text-align: right;">↗</td></tr> <tr><td>16:</td><td>10.5x</td><td style="text-align: right;">↗</td></tr> <tr><td>17:</td><td>10.7x</td><td style="text-align: right;">→</td></tr> <tr><td>18:</td><td>10.4</td><td style="text-align: right;">→</td></tr> <tr><td>19:</td><td>10.7x</td><td style="text-align: right;">→</td></tr> <tr><td>20:</td><td>9.7</td><td style="text-align: right;">↘</td></tr> <tr><td colspan="2">Serie</td><td style="text-align: right;">98.0</td></tr> <tr><td colspan="2">Total</td><td style="text-align: right;">197.0</td></tr> </table>	11:	9.9	→	12:	10.5	↗	13:	10.4	↘	14:	10.5x	↘	15:	10.3	↗	16:	10.5x	↗	17:	10.7x	→	18:	10.4	→	19:	10.7x	→	20:	9.7	↘	Serie		98.0	Total		197.0
11:	9.9	→																																			
12:	10.5	↗																																			
13:	10.4	↘																																			
14:	10.5x	↘																																			
15:	10.3	↗																																			
16:	10.5x	↗																																			
17:	10.7x	→																																			
18:	10.4	→																																			
19:	10.7x	→																																			
20:	9.7	↘																																			
Serie		98.0																																			
Total		197.0																																			

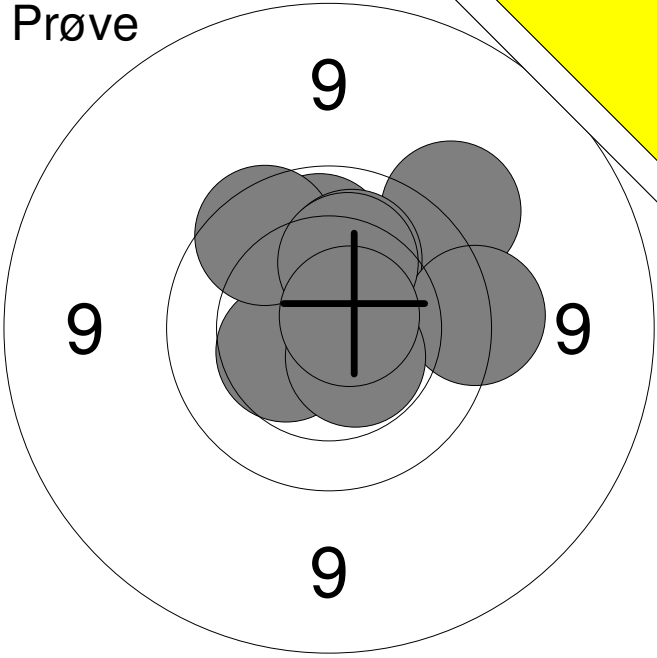
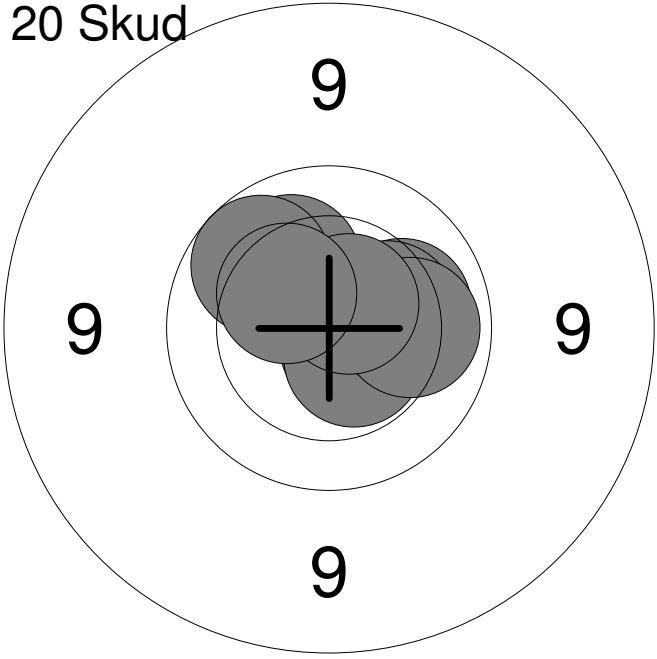
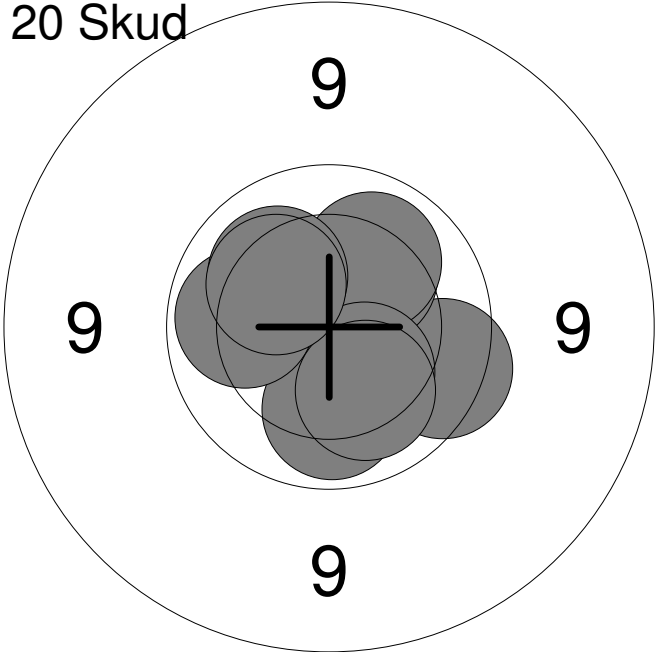
Hold	Skive	Charlotte Larsen	
74	4	15m	Vilsted Skf. ÅK1
24.10.2013	15 meter riffelstævne 2013	Aalborg Skyttekreds	
Prøve 	1:	10.4	↙
	2:	10.0	↑
	3:	9.5	↗
	4:	9.8	↗
	5:	10.2	↑
	6:	9.6	→
	7:	10.5x	↘
	8:	10.2	↑
	9:	10.7x	↗
	Serie		87.0
Total		0.0	
20 Skud 	1:	10.8x	↗
	2:	10.7x	↘
	3:	10.1	↗
	4:	10.1	→
	5:	10.5x	↘
	6:	10.3	→
	7:	9.9	↗
	8:	10.1	→
	9:	10.6x	↗
	10:	10.4	↗
Serie		99.0	
Total		99.0	
20 Skud 	11:	9.8	→
	12:	10.7x	↘
	13:	10.3	↗
	14:	10.1	↗
	15:	10.3	↘
	16:	10.1	↘
	17:	10.0	←
	18:	10.2	↗
	19:	10.2	↘
	20:	10.2	↗
Serie		99.0	
Total		198.0	

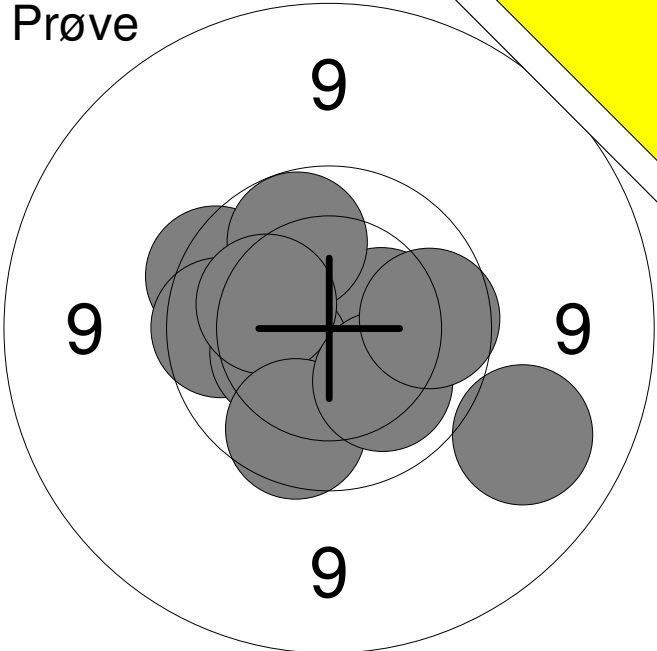
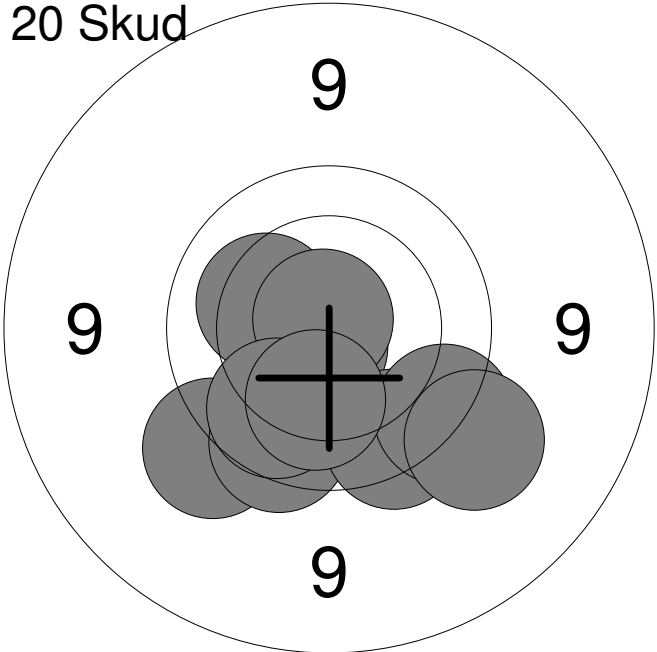
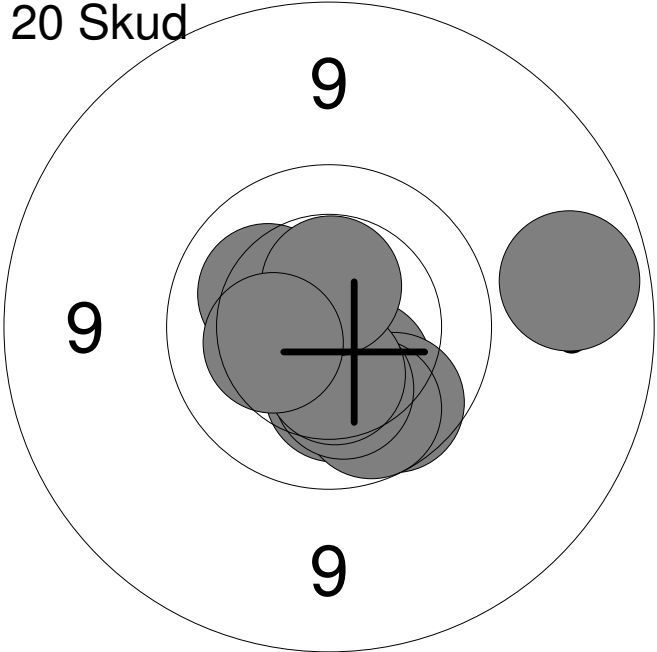
Hold	Skive	Jens Niss	
74	5	Mou & Omegns Skf.	MÅ2
15m			
24.10.2013	15 meter riffelstævne 2013	Aalborg Skyttekreds	
Prøve 	1:	9.8	↗
	2:	10.4	→
	3:	9.9	←
	4:	10.0	↗
	5:	10.4	←
	6:	10.2	↗
	7:	9.9	↘
	8:	10.1	↘
	9:	9.2	↘
	10:	9.9	→
	Serie		95.0
Total		0.0	
20 Skud 	1:	10.7x	↘
	2:	10.2	↗
	3:	9.5	↘
	4:	9.8	↘
	5:	10.8x	↗
	6:	9.7	↘
	7:	9.9	↘
	8:	9.6	↘
	9:	9.4	↘
	10:	10.2	↘
Serie		94.0	
Total		94.0	
20 Skud 	11:	9.0	→
	12:	10.4	↘
	13:	9.9	↘
	14:	10.2	↘
	15:	10.0	↘
	16:	10.3	↘
	17:	10.2	↗
	18:	10.4	↘
	19:	10.5x	↑
	20:	10.3	←
Serie		98.0	
Total		192.0	

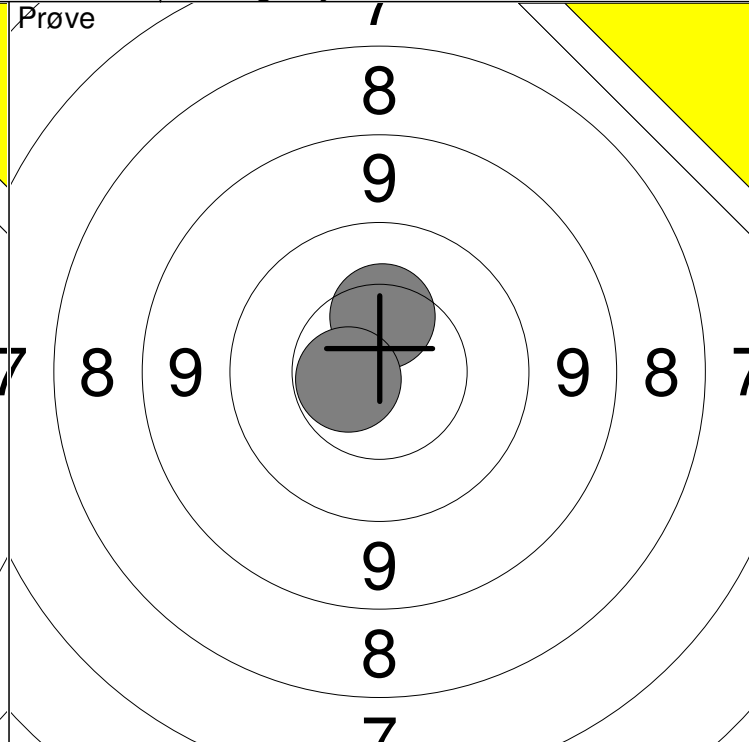
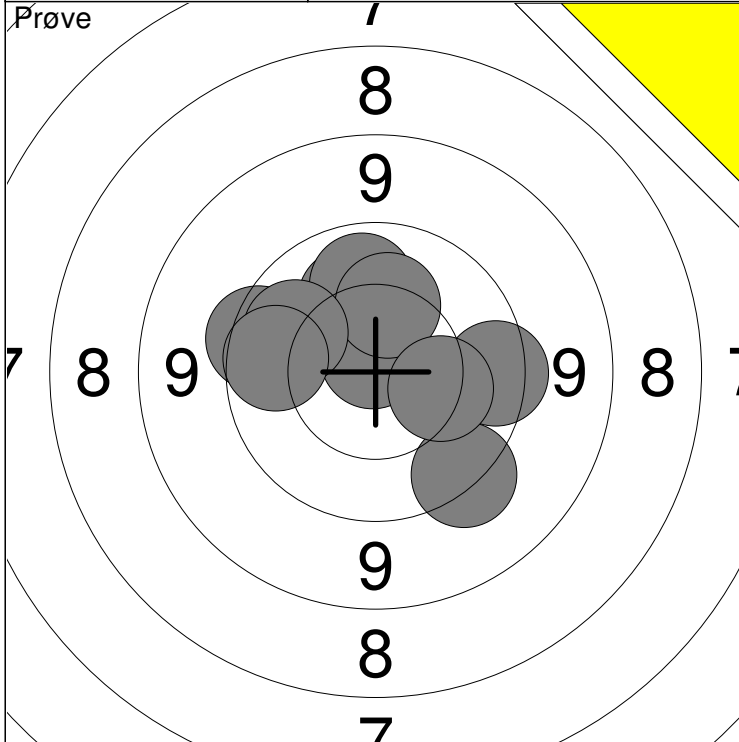

1: 9.7 ←	6: 9.5 ↘	Serie 96
2: 10.2 ↑	7: 10.0 ↗	
3: 10.0 ↑	8: 9.9 ←	Total 0
4: 10.8x ↑	9: 9.7 →	
5: 10.3 ↑	10: 10.3 →	

11: 10.4 ↑	Serie 20
12: 10.6x ←	
Total 0	

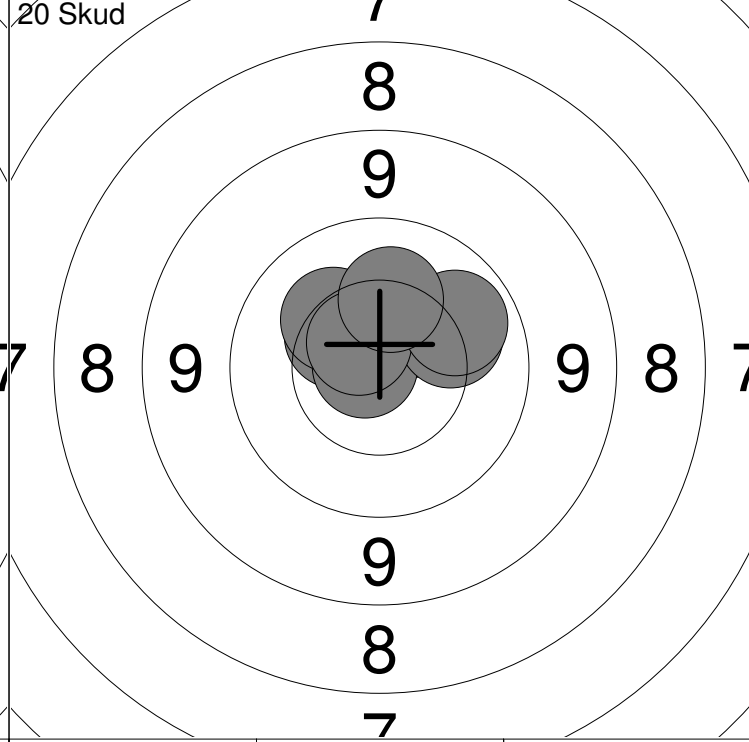
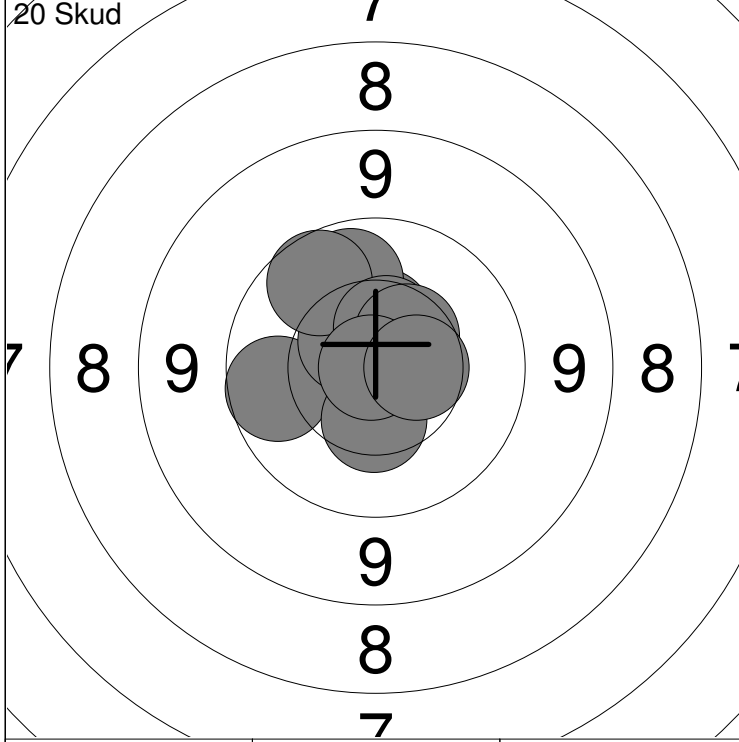

1: 9.9 ←	6: 9.9 ↗	Serie 98
2: 10.5 ↑	7: 10.5 ↑	
3: 10.4 ↓	8: 10.5 ↗	Total 98
4: 10.0 ↑	9: 10.9x ←	
5: 10.6 ↖	10: 10.5 →	

11: 10.6 ↑	16: 10.3 ↖	Serie 100
12: 10.4 ↗	17: 10.1 →	
13: 10.4 ↖	18: 10.6x ↖	Total 198
14: 10.4 ↑	19: 10.0 ↗	
15: 10.8x ←	20: 10.2 ↑	

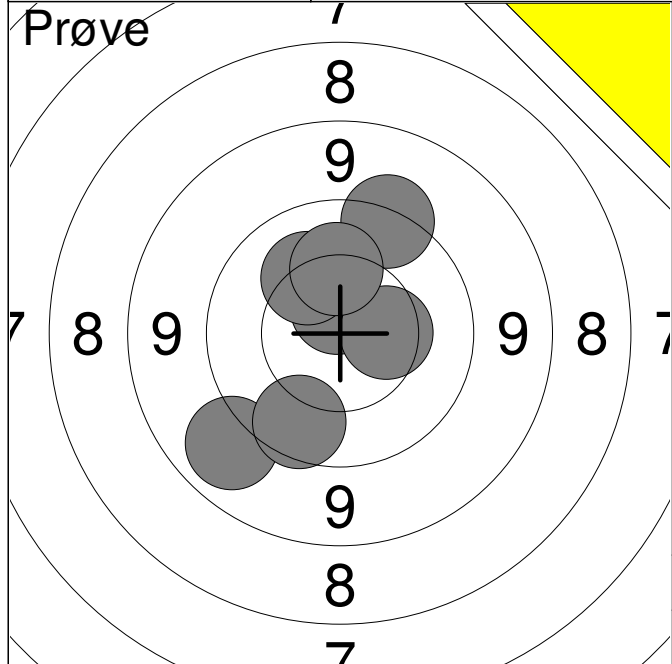

1:	9.1	↙
2:	9.8	↙
3:	10.6x	↑
4:	9.5	↗
5:	10.2	↗
6:	10.4	→
7:	10.2	↑
Serie		67.0
Total		0.0

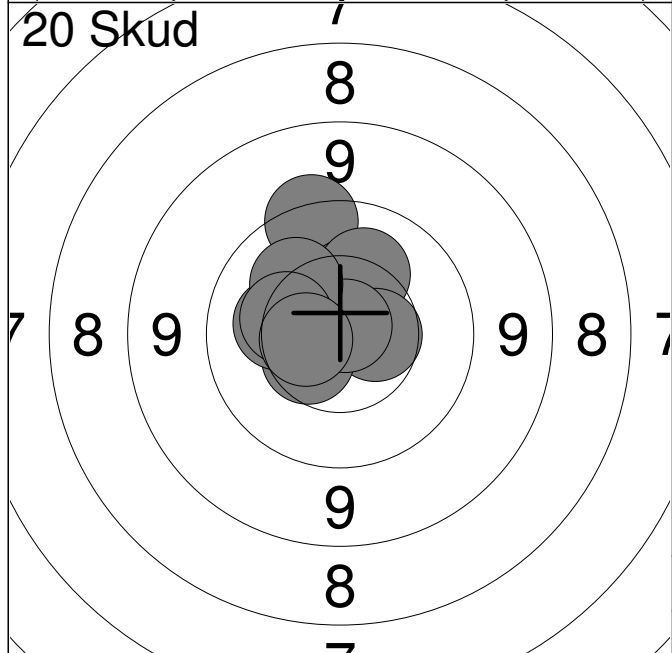

1:	9.6	↑
2:	10.4	↑
3:	10.2	↗
4:	10.5	→
5:	10.5	↙
6:	10.8x	↗
7:	10.2	←
8:	10.2	↗
9:	10.3	←
10:	10.5	←
Serie		99.0
Total		99.0

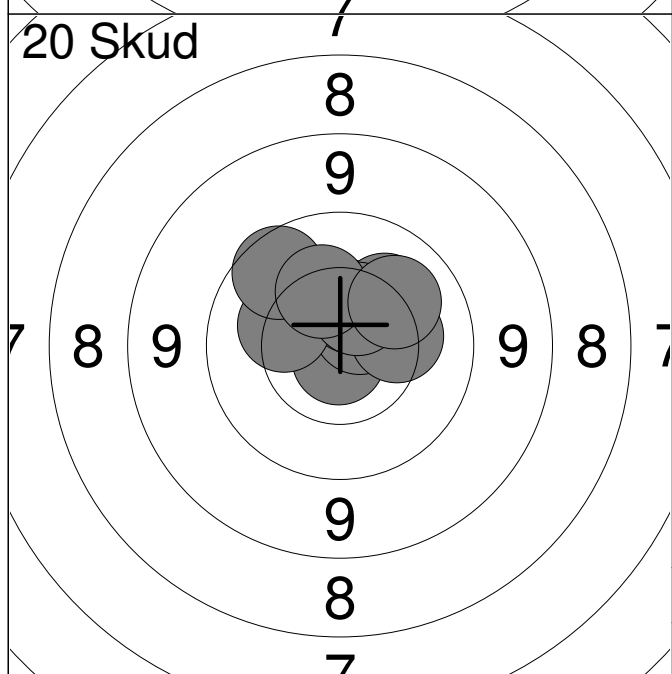

11:	10.8x	↓
12:	10.6x	↗
13:	10.5	↑
14:	10.2	↗
15:	10.3	←
16:	9.8	↗
17:	10.3	→
18:	10.5	↗
19:	10.3	↗
20:	10.1	↗
Serie		99.0
Total		198.0

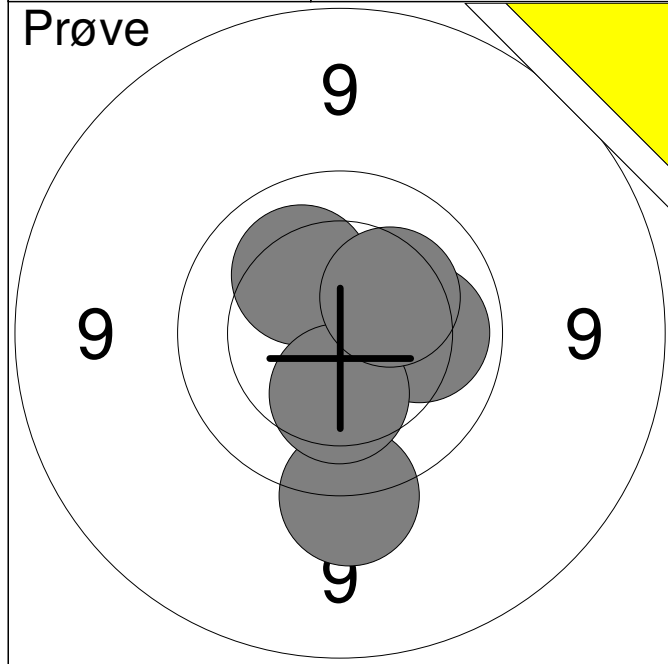

1:	9.5	↓
2:	10.2	↗
3:	10.1	→
4:	10.3	↓
5:	10.3	↗
Serie		49.0
Total		0.0

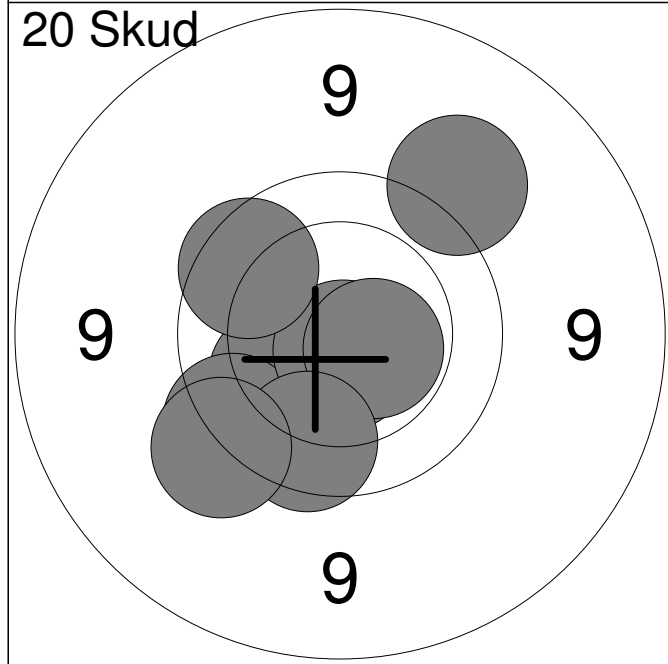

1:	10.0	↙
2:	9.4	↗
3:	10.7x	↓
4:	10.1	↙
5:	9.7	↙
6:	10.8x	↓
7:	10.6x	→
8:	9.8	↗
9:	9.8	↓
10:	9.5	↙
Serie		95.0
Total		95.0

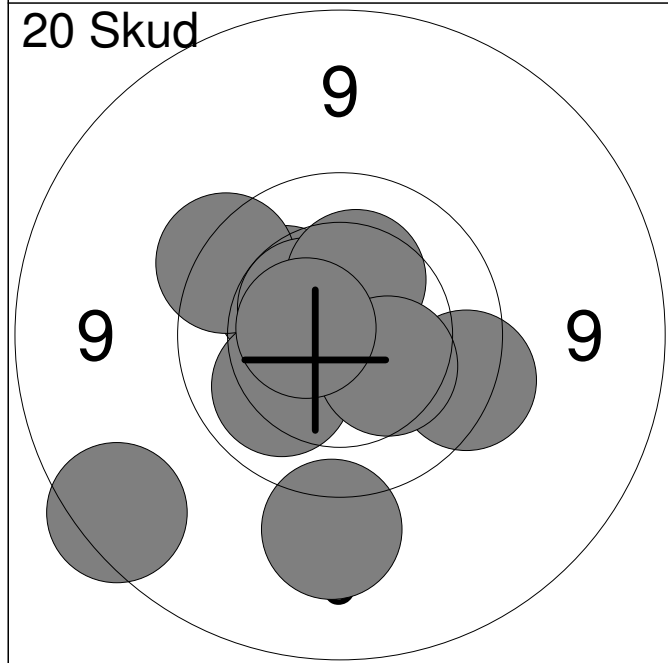

11:	9.7	→
12:	10.2	↗
13:	9.7	↗
14:	10.5x	↗
15:	10.1	↙
16:	10.3	↗
17:	8.8	↙
18:	10.3	↘
19:	9.3	↓
20:	10.6x	←
Serie		95.0
Total		190.0

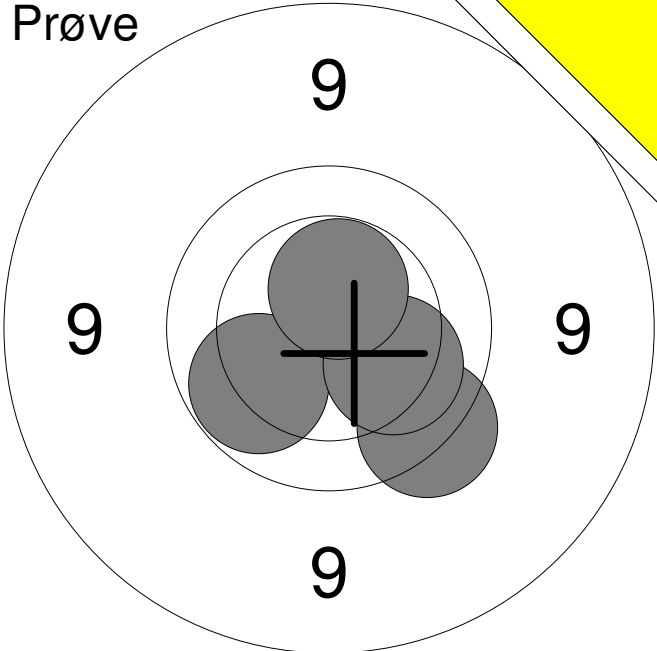
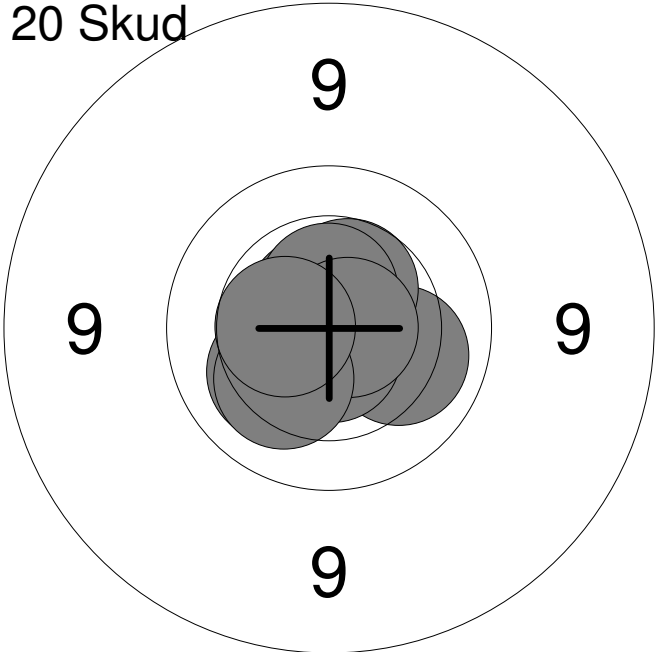
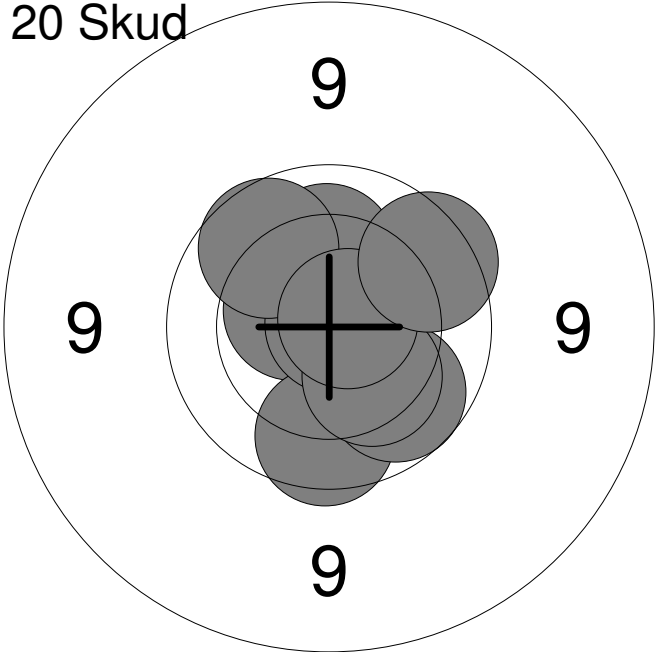
Hold	Skive	Mike R. M. Jensen	
74	9	Hobro Egnens Skytteforening	MJ2
24.10.2013	15 meter riffelstævne 2013	Aalborg Skyttekreds	
Prøve		1: 9.7 ↘	
		2: 10.0 ↙	
		3: 10.2 ↘	
		4: 10.5x ↑	
		Serie	39.0
		Total	0.0
20 Skud		1: 10.7x ↑	
		2: 10.1 ↘	
		3: 10.5 ↑	
		4: 10.6x ↑	
		5: 10.4 ↙	
		6: 10.7x ↓	
		7: 10.7x →	
		8: 10.2 ↙	
		9: 10.2 ↙	
		10: 10.5 ←	
		Serie	100.0
		Total	100.0
20 Skud		11: 10.7x ↑	
		12: 10.5x ↙	
		13: 10.2 ↑	
		14: 9.8 ↓	
		15: 9.9 ↘	
		16: 10.9x →	
		17: 9.9 ↑	
		18: 10.2 ↓	
		19: 10.7x →	
		20: 9.8 ↗	
		Serie	96.0
		Total	196.0

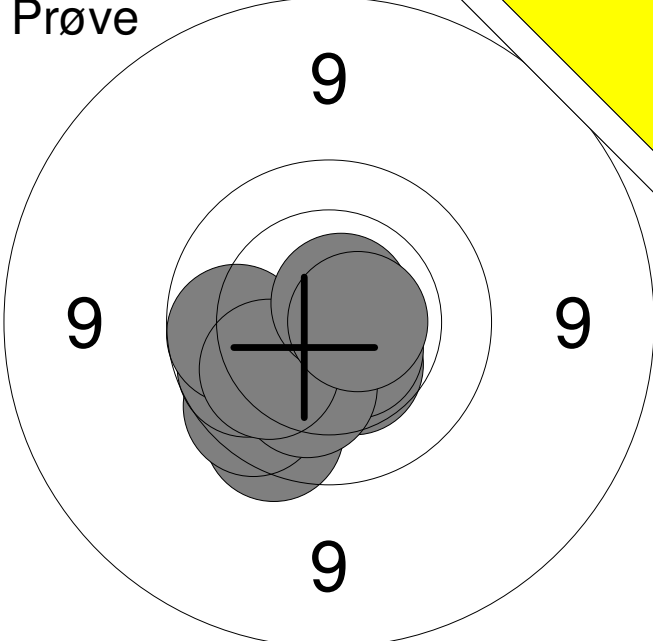
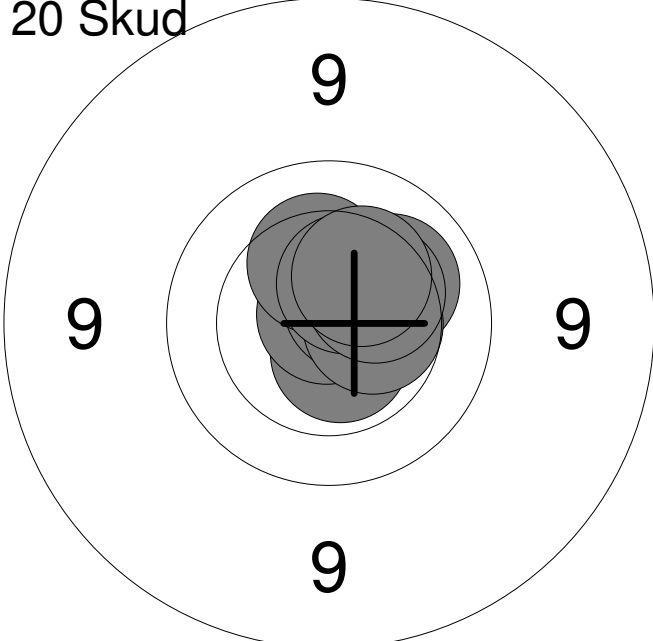
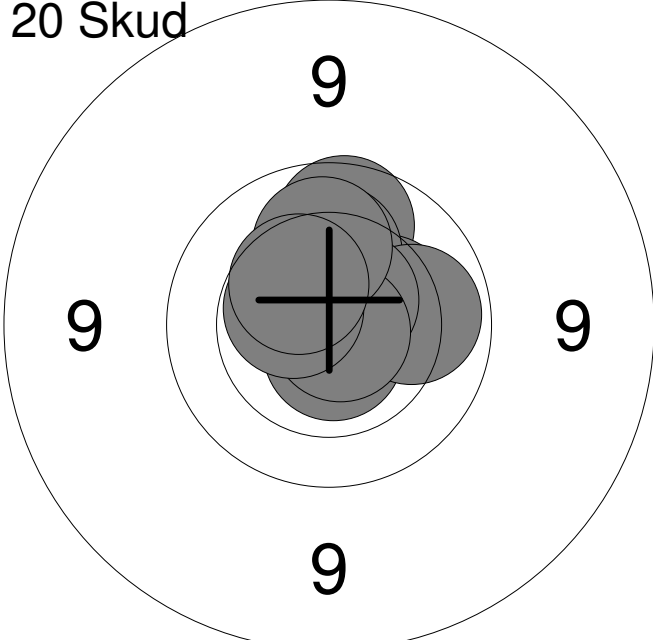
Hold	Skive	Nicki R. M. Jensen	
74	10	Hobro Egnens Skytteforening	MB1
24.10.2013	15 meter riffelstævne 2013	Aalborg Skyttekreds	
Prøve 	1:	9.8	↙
	2:	9.8	↙
	3:	10.4	↘
	4:	10.6x	↘
	5:	10.2	↘
	6:	9.9	↙
	7:	9.9	←
	8:	10.1	↙
	9:	10.7x	↗
	10:	10.6x	→
	Serie		96.0
Total		0.0	
20 Skud 	1:	10.2	↗
	2:	10.6x	↘
	3:	10.9x	↑
	4:	10.5x	↗
	5:	10.6x	↗
	6:	10.3	↑
	7:	10.5	→
	8:	10.5	↑
	9:	10.4	↗
	10:	10.3	↗
	Serie		100.0
Total		100.0	
20 Skud 	11:	9.9	↑
	12:	10.3	→
	13:	10.7x	↘
	14:	10.2	↑
	15:	10.0	→
	16:	10.6x	↗
	17:	10.8x	↘
	18:	10.5x	↙
	19:	10.1	↑
	20:	10.4	↗
	Serie		99.0
Total		199.0	

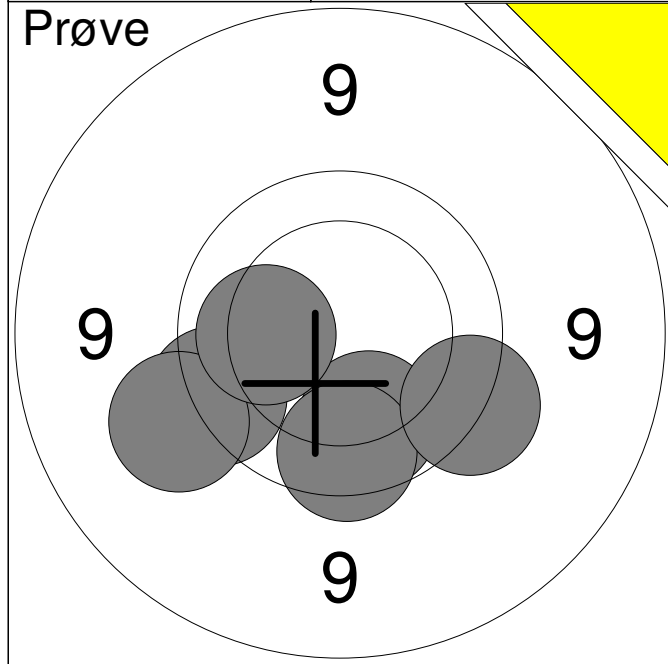

1:	9.7	↙
2:	9.4	↙
3:	10.0	↓
4:	9.8	↓
5:	9.6	↘
6:	10.2	←
Serie	56.0	
Total	0.0	

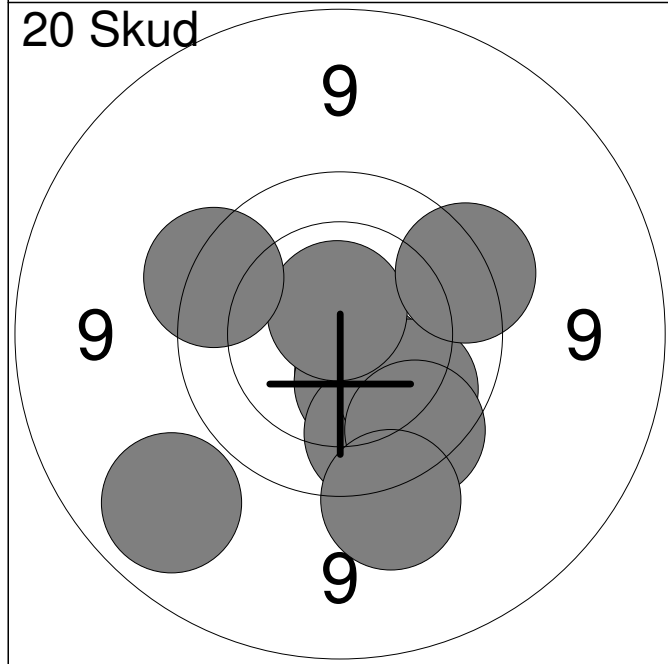

1:	10.5	↘
2:	10.4	↘
3:	9.9	↘
4:	9.1	↙
5:	10.0	↘
6:	9.8	↘
7:	10.7x	↑
8:	9.7	↗
9:	9.5	↘
10:	9.7	↗
Serie	94.0	
Total	94.0	

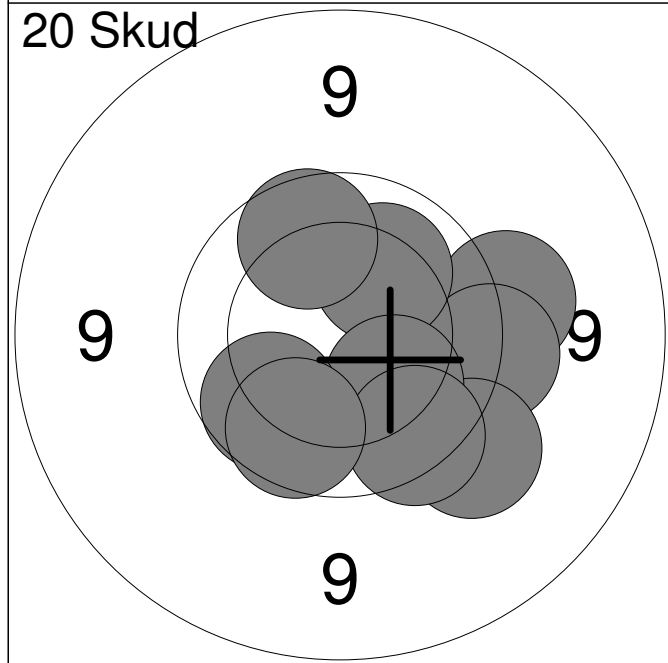

11:	9.6	→
12:	9.5	→
13:	9.6	→
14:	10.1	↗
15:	9.9	↗
16:	9.5	↘
17:	10.2	↘
18:	9.9	↙
19:	9.7	↘
20:	9.9	↘
Serie	92.0	
Total	186.0	

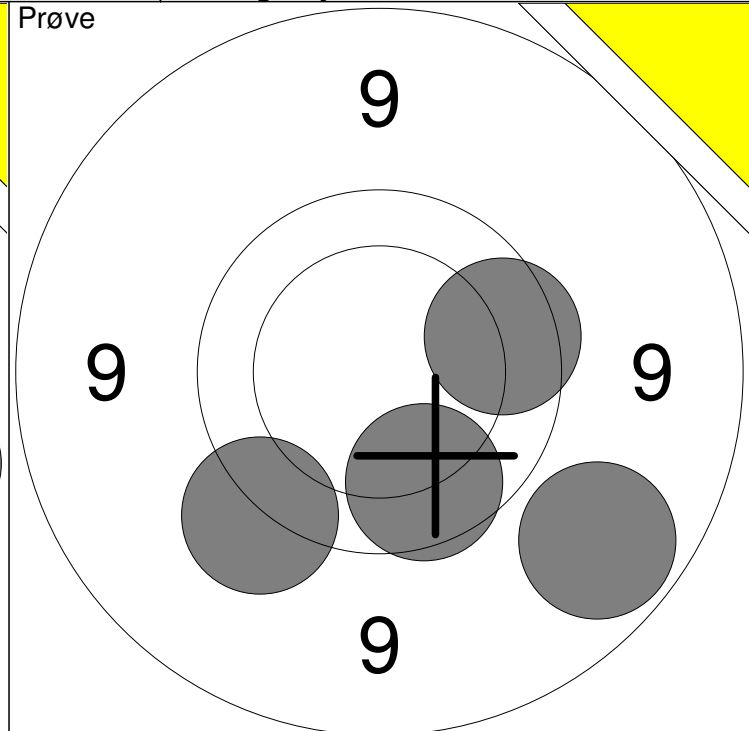
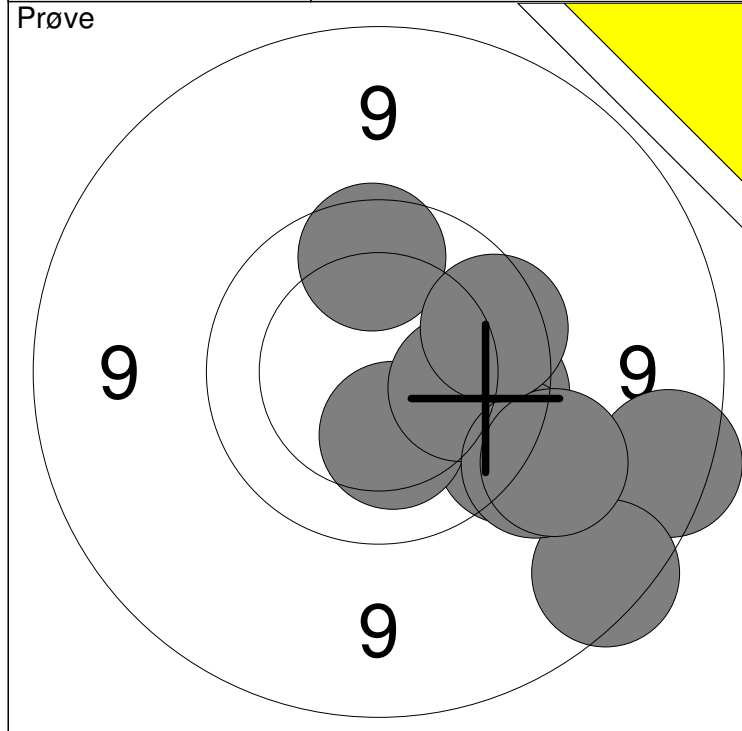

1: 8.8 →	6: 10.1 →	Serie	90
2: 8.8 ↓	7: 9.5 ↓		
3: 9.8 →	8: 9.4 ↓	Total	0
4: 9.6 ↓	9: 9.9 ↑		
5: 10.3 ↓	10: 9.8 →		

11: 9.9 ↓	Serie	36
12: 9.0 ↓		
13: 9.8 →	Total	0
14: 9.5 ↓		

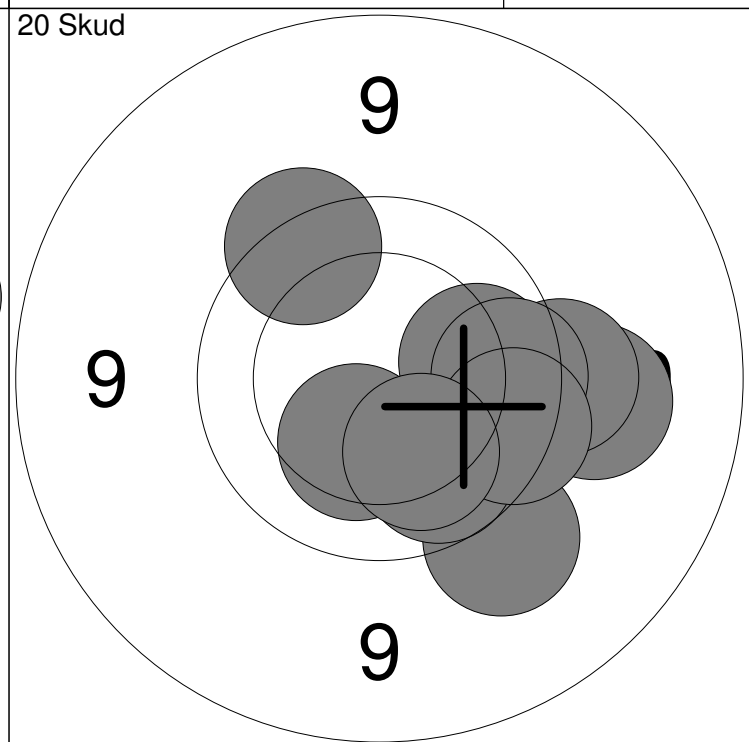
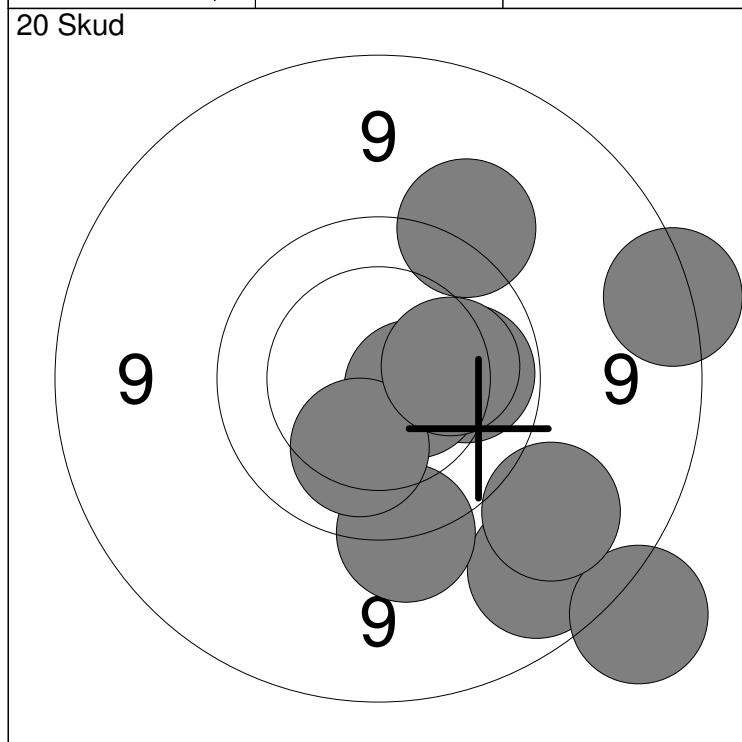

1: 9.0 ↓	6: 10.6x →	Serie	92
2: 8.6 ↓	7: 9.4 ↑		
3: 9.6 ↓	8: 10.2 ↓	Total	92
4: 9.2 ↓	9: 8.7 →		
5: 10.0 →	10: 10.2 →		

11: 9.3 →	16: 9.4 ↓	Serie	93
12: 9.5 →	17: 10.3 ↓		
13: 9.7 ↑	18: 9.9 ↓	Total	185
14: 10.0 →	19: 9.7 ↓		
15: 9.8 →	20: 10.1 ↓		

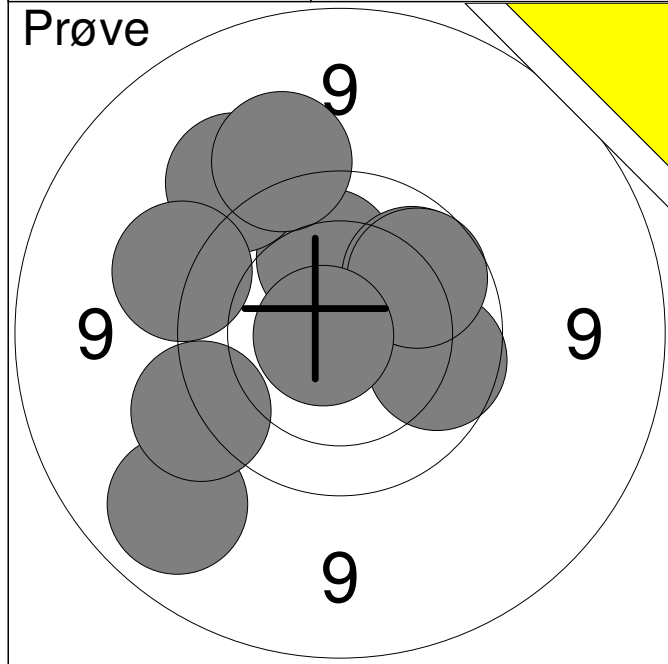

1:	10.1	↑
2:	9.4	↗
3:	9.5	↖
4:	9.9	→
5:	9.4	↑
6:	10.0	↗
7:	9.1	↙
8:	9.9	↗
9:	9.5	↙
10:	10.8x	←
Serie		93.0
Total		0.0



1:	10.7x	↙
2:	9.9	→
3:	9.8	→
4:	10.5x	↑
5:	9.4	↙
6:	9.8	←
7:	9.5	←
8:	10.1	←
9:	10.0	↙
10:	10.3	↑
Serie		95.0
Total		95.0

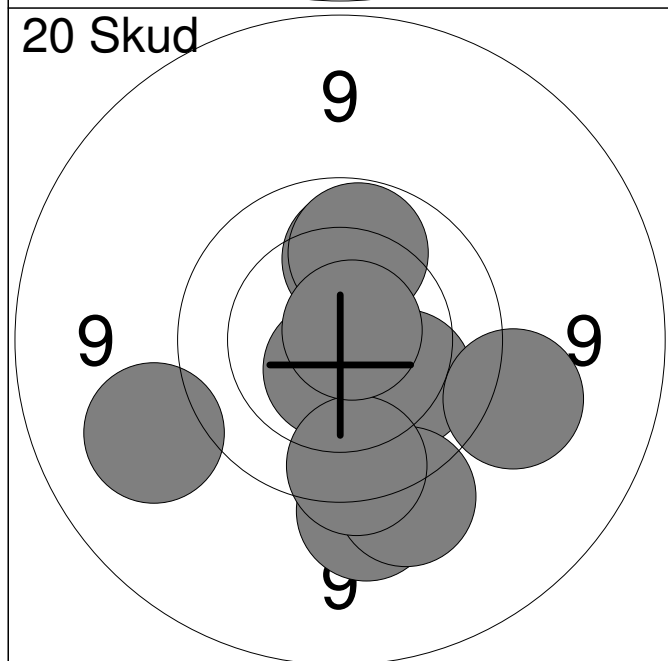

11:	10.6x	↙
12:	10.1	↑
13:	9.5	↙
14:	10.1	↙
15:	10.0	↑
16:	9.5	↙
17:	9.7	↙
18:	9.2	←
19:	10.8x	↗
20:	9.4	→
Serie		95.0
Total		190.0

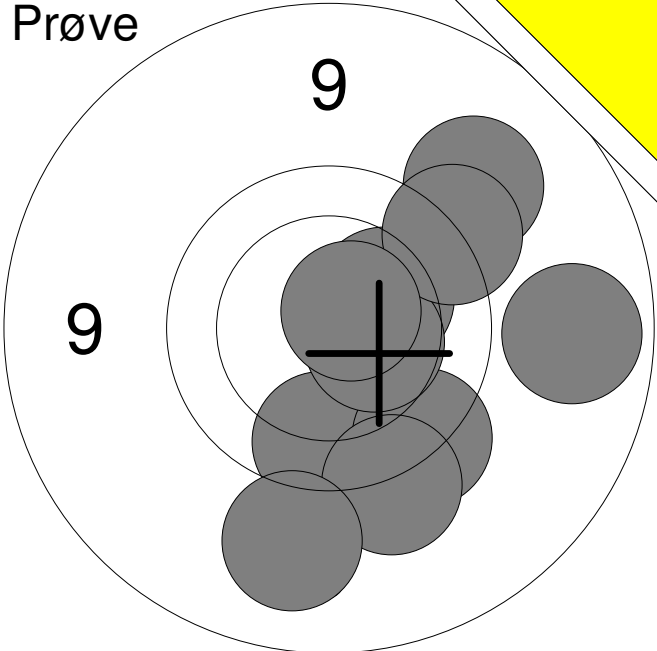
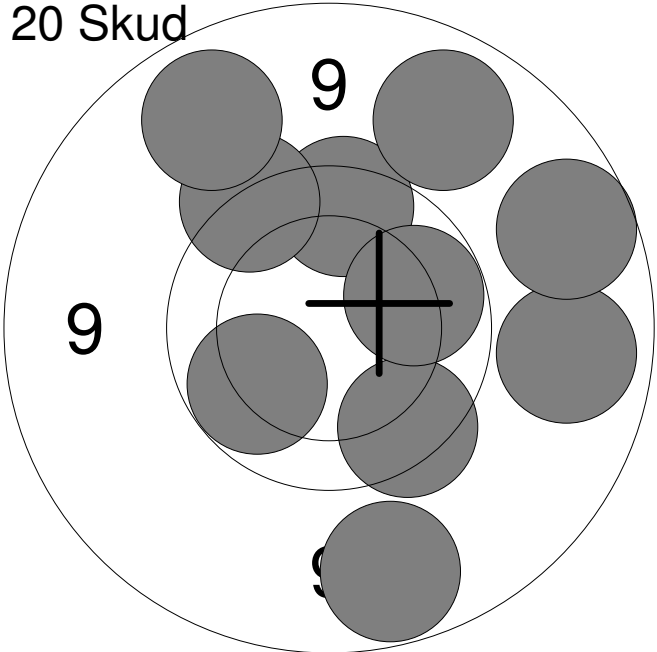
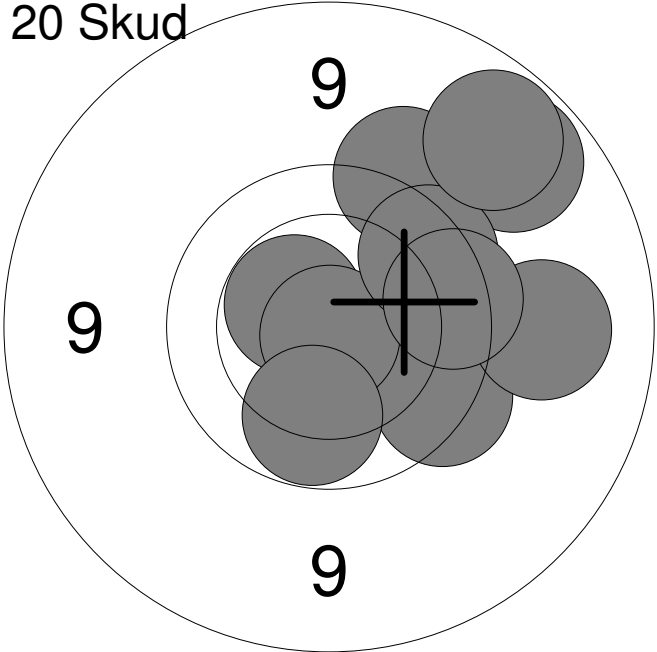
Hold	Skive	Jonas Bonde Lauersen	
75	4	15m	Mou & Omegns Skf. MB4
24.10.2013	15 meter riffelstævne 2013	Aalborg Skyttekreds	
Prøve 	1:	9.8	↓
	2:	9.6	↘
	3:	9.5	↓
	4:	10.3	↗
	5:	9.3	↗
	6:	9.2	↓
	7:	10.4	↗
	8:	9.6	↗
	9:	10.6x	↗
	10:	9.0	→
	Serie		93.0
Total		0.0	
20 Skud 	1:	10.0	↙
	2:	9.0	→
	3:	9.8	↑
	4:	9.1	↗
	5:	8.9	→
	6:	9.7	↓
	7:	9.0	↓
	8:	10.0	→
	9:	9.6	↗
	10:	9.0	↗
	Serie		91.0
Total		91.0	
20 Skud 	11:	9.7	↘
	12:	9.0	↗
	13:	10.5x	↗
	14:	9.2	→
	15:	9.5	↗
	16:	10.9x	↓
	17:	9.8	↗
	18:	9.7	→
	19:	10.0	↓
	20:	9.0	↗
	Serie		93.0
Total		184.0	

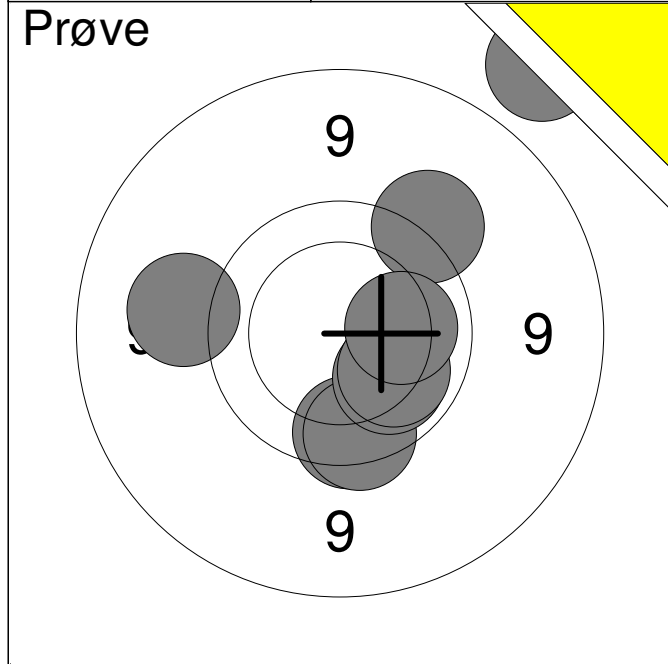

1:	9.8	↓
2:	9.7	↓
3:	9.5	↗
4:	10.1	↓
5:	8.3	↗
6:	10.1	↓
7:	10.1	→
8:	9.3	←
Serie		74.0
Total		0.0

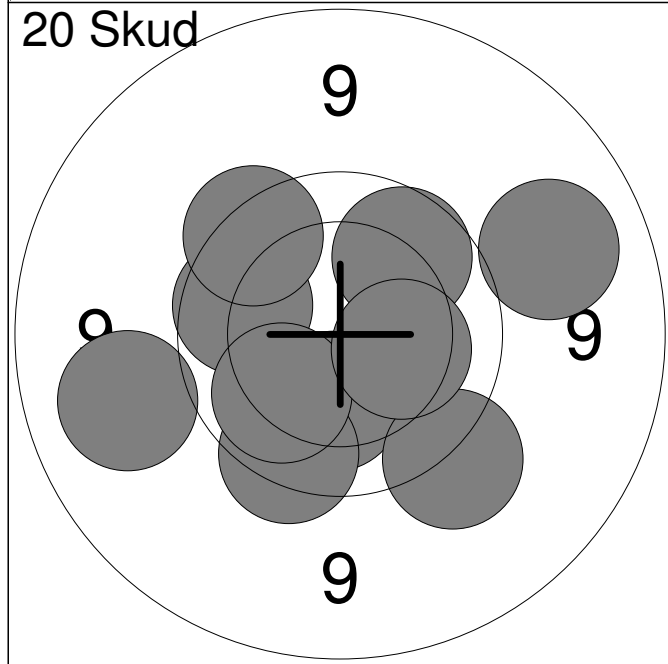

1:	10.2	↓
2:	9.7	↓
3:	9.1	←
4:	9.5	↓
5:	9.9	↗
6:	9.1	→
7:	10.1	↓
8:	9.9	↗
9:	9.7	↗
10:	10.3	→
Serie		93.0
Total		93.0

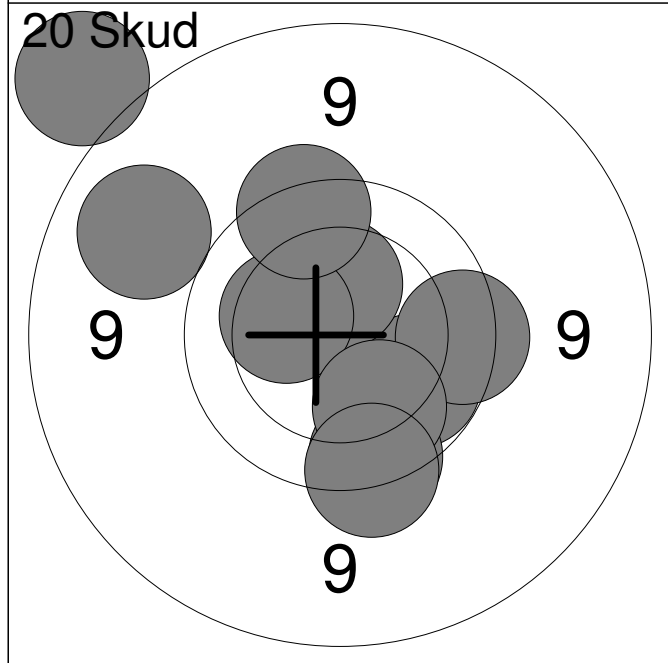

11:	9.1	↗
12:	10.0	↓
13:	9.7	↓
14:	10.4	↗
15:	9.7	→
16:	10.3	↗
17:	8.5	↗
18:	10.0	↓
19:	9.7	↗
20:	9.6	↓
Serie		93.0
Total		186.0

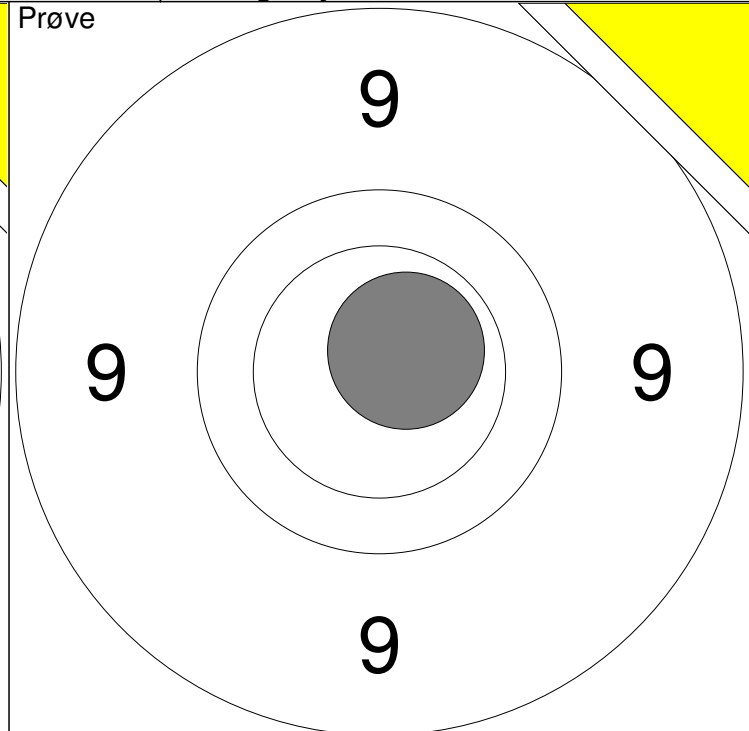
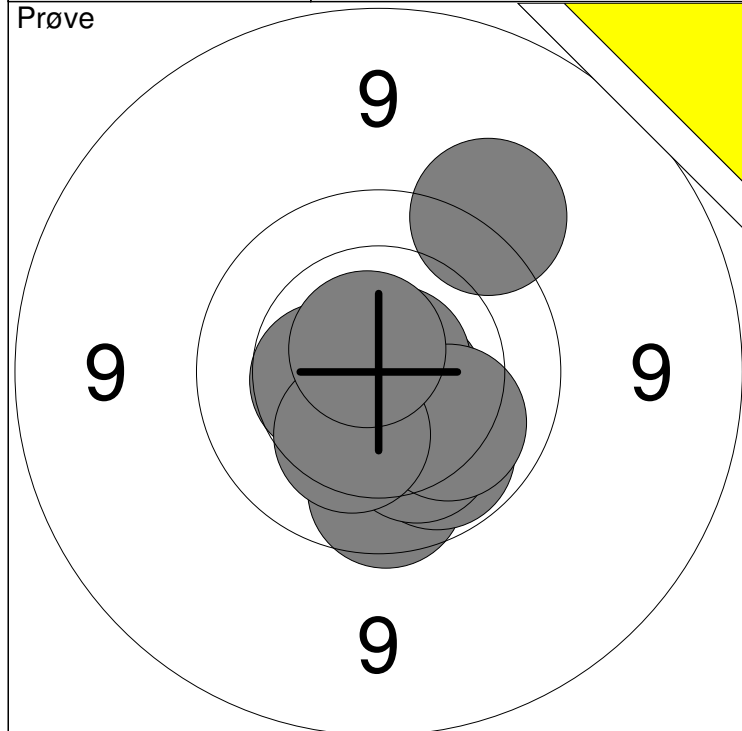

1: 9.5 ↗	6: 10.0 ↓	Serie	98
2: 10.6x ↘	7: 10.2 ↓		
3: 10.5 ←	8: 10.1 ↓	Total	0
4: 10.8x ↗	9: 10.3 ↓		
5: 9.9 ↓	10: 10.7x ↗		

11: 10.6x ↗		Serie	10
		Total	0

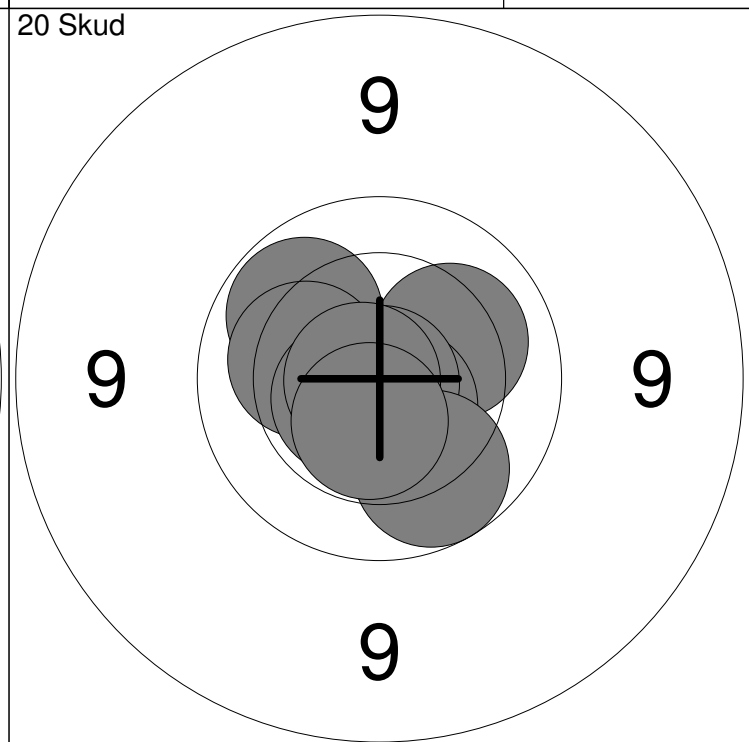
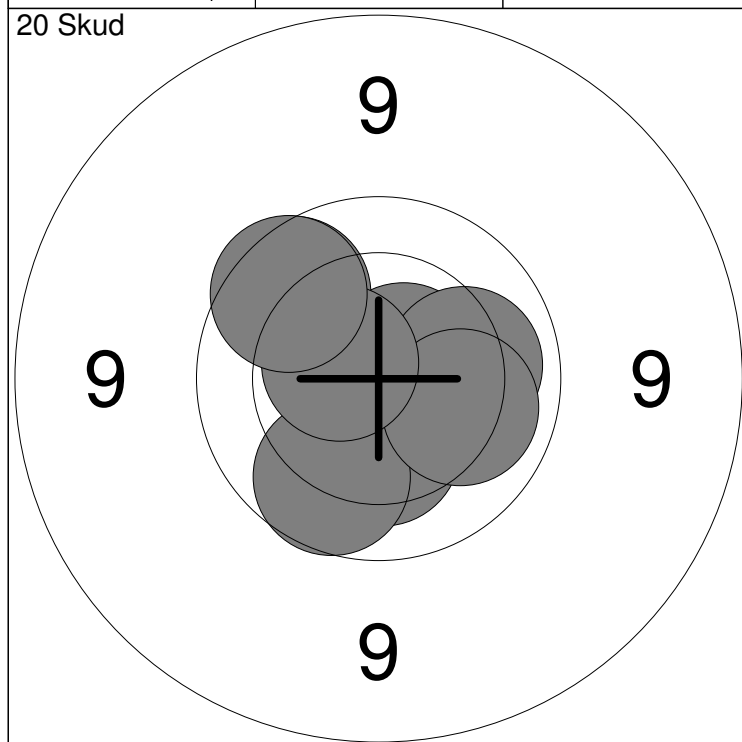

1: 10.4 →	6: 9.9 ↓	Serie	97
2: 10.5 ↓	7: 10.1 ↘		
3: 10.3 ↓	8: 9.9 ↗	Total	97
4: 10.7x ↗	9: 10.6x ↗		
5: 10.1 →	10: 9.8 ↗		

11: 10.0 ↗	16: 10.6x ↘	Serie	99
12: 10.4 ↓	17: 10.9x ↓		
13: 10.2 ←	18: 9.9 ↓	Total	196
14: 10.2 ↗	19: 10.8x ←		
15: 10.6x ↓	20: 10.5x ↓		

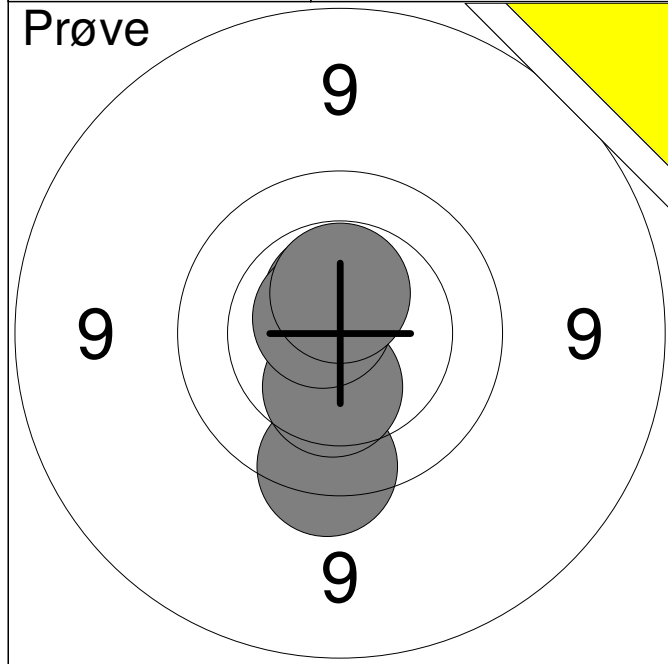

1:	9.7	↓
2:	10.4	↓
3:	10.6x	↑
4:	10.7x	↗
5:	10.5x	↑
Serie		49.0
Total		0.0

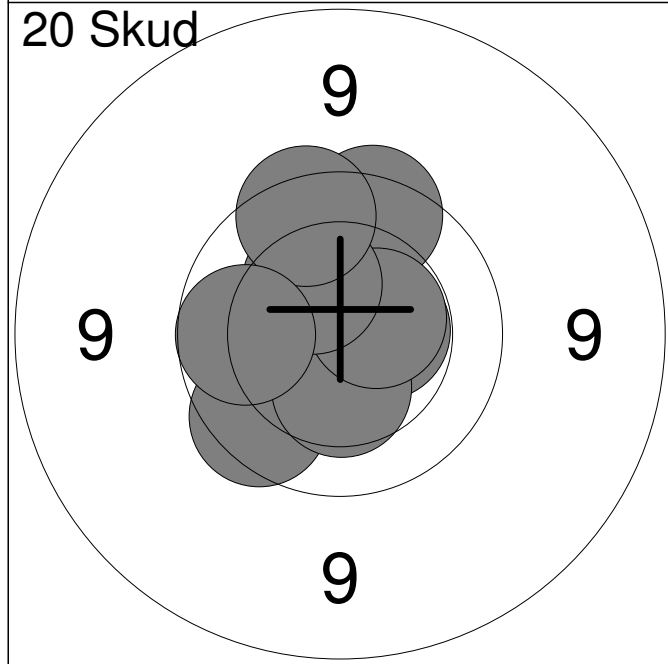

1:	10.0	↑
2:	9.8	↑
3:	9.8	↙
4:	10.5x	→
5:	10.7x	←
6:	10.4	↓
7:	10.5x	↗
8:	10.3	↑
9:	9.8	↑
10:	9.9	←
Serie		96.0
Total		96.0

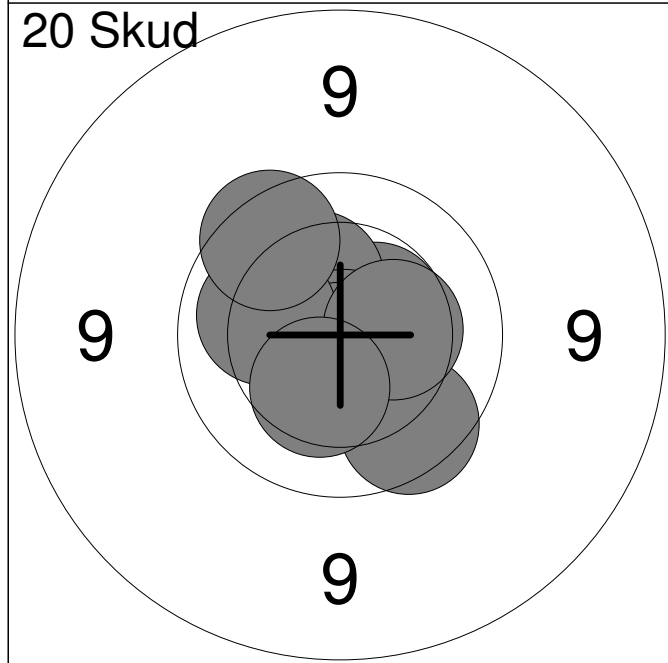

11:	10.5x	↗
12:	10.3	↑
13:	10.9x	↙
14:	10.8x	↓
15:	10.4	↓
16:	9.8	↓
17:	10.1	↑
18:	10.4	→
19:	9.8	↑
20:	10.3	↙
Serie		98.0
Total		194.0

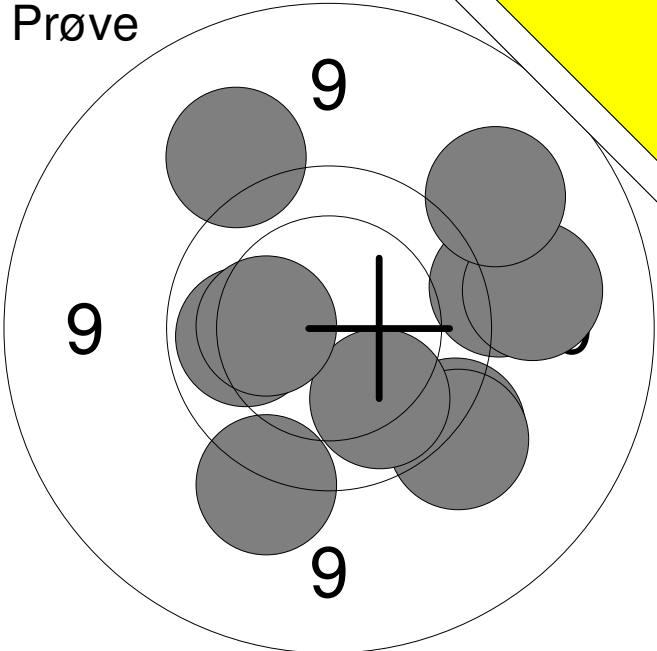
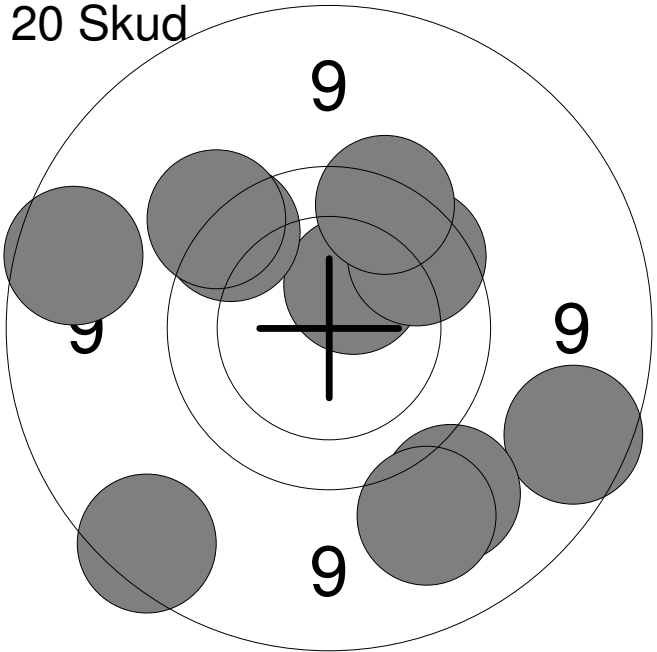
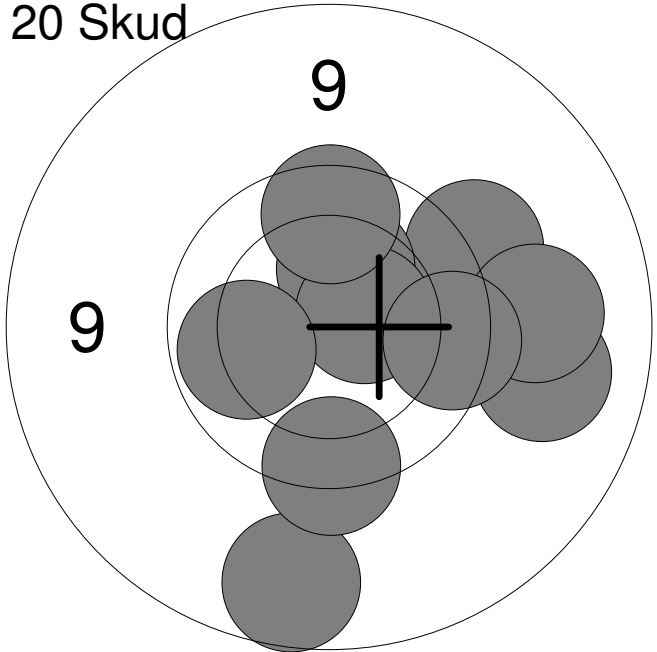
Hold	Skive	Kåre L. Nielsen		
75	8	15m	Mou & Omegns Skf.	MÅ3
24.10.2013	15 meter riffelstævne 2013	Aalborg Skyttekreds		
Prøve 	1:	9.5	↘	
	2:	9.5	↘	
	3:	9.4	→	
	4:	10.1	←	
	5:	9.5	↘	
	6:	9.2	→	
	7:	9.3	↗	
	8:	10.0	↘	
	9:	9.2	↗	
	10:	10.3	←	
	Serie			93.0
Total			0.0	
20 Skud 	1:	10.4	↗	
	2:	9.8	↗	
	3:	8.9	↘	
	4:	9.2	↘	
	5:	9.7	↗	
	6:	8.9	←	
	7:	9.7	↗	
	8:	9.6	↗	
	9:	9.2	↘	
	10:	8.8	↘	
	Serie			88.0
Total			88.0	
20 Skud 	11:	8.9	↓	
	12:	9.5	→	
	13:	10.3	↑	
	14:	9.2	→	
	15:	10.5x	→	
	16:	9.8	↑	
	17:	9.2	→	
	18:	9.8	→	
	19:	10.0	←	
	20:	9.7	↓	
	Serie			92.0
Total			180.0	

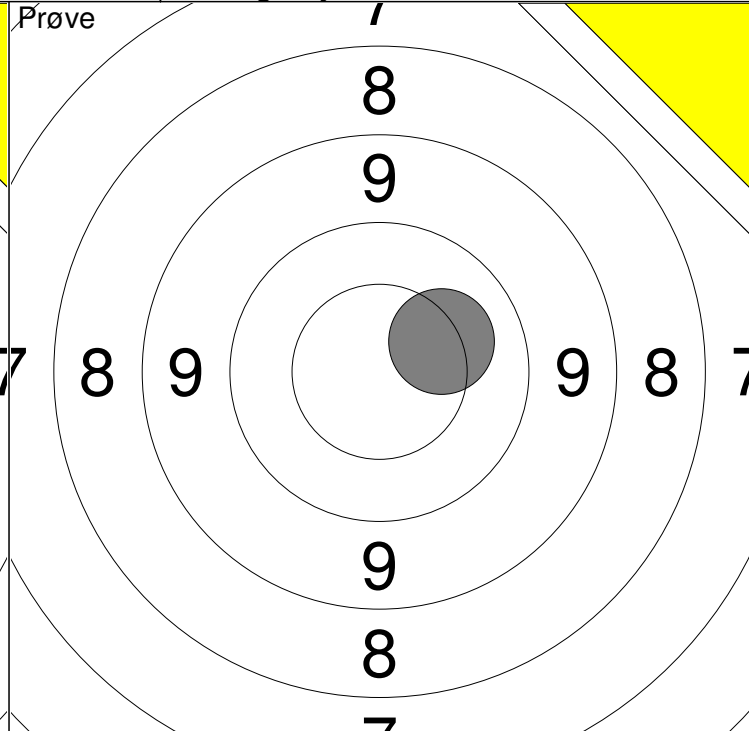
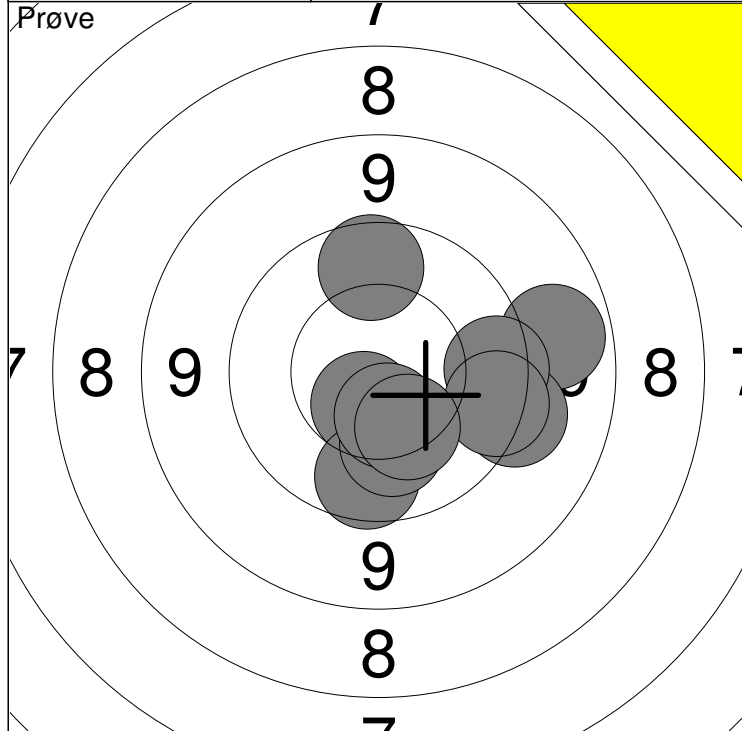

1: 9.0 →	6: 9.7 →	Serie	94
2: 10.6 ↓	7: 10.5 ↓		
3: 9.9 ↓	8: 9.7 →	Total	0
4: 9.4 →	9: 10.3 ↓		
5: 10.2 ↓	10: 9.9 ↑		

11: 10.2 ↗	Serie	10
Total		0

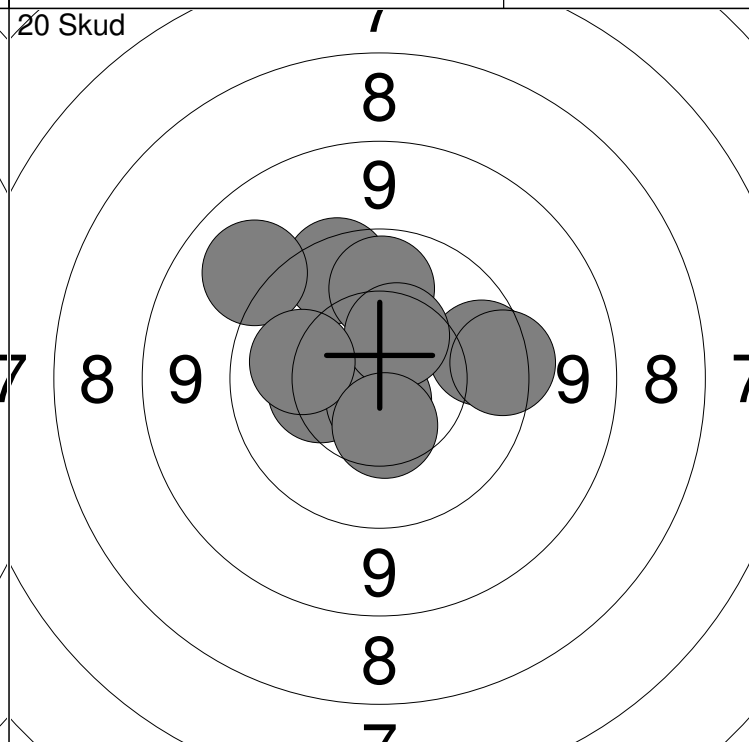
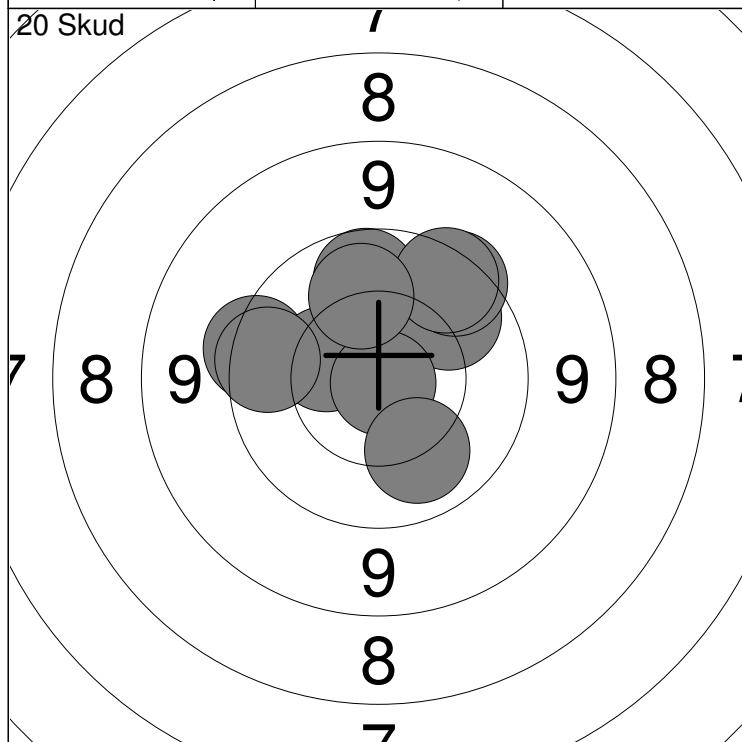

1: 10.0 ↗	6: 10.9x ↓	Serie	95
2: 9.7 ↗	7: 9.7 ↗		
3: 9.6 ←	8: 10.1 ↓	Total	95
4: 9.9 ↑	9: 10.1 ↑		
5: 10.4 ←	10: 9.8 ←		

11: 10.3 ←	16: 10.7x ↓	Serie	96
12: 9.9 →	17: 10.5 ↗		
13: 9.6 →	18: 9.2 ↖	Total	191
14: 9.7 ↗	19: 10.1 ←		
15: 10.0 ↑	20: 10.5 ↓		

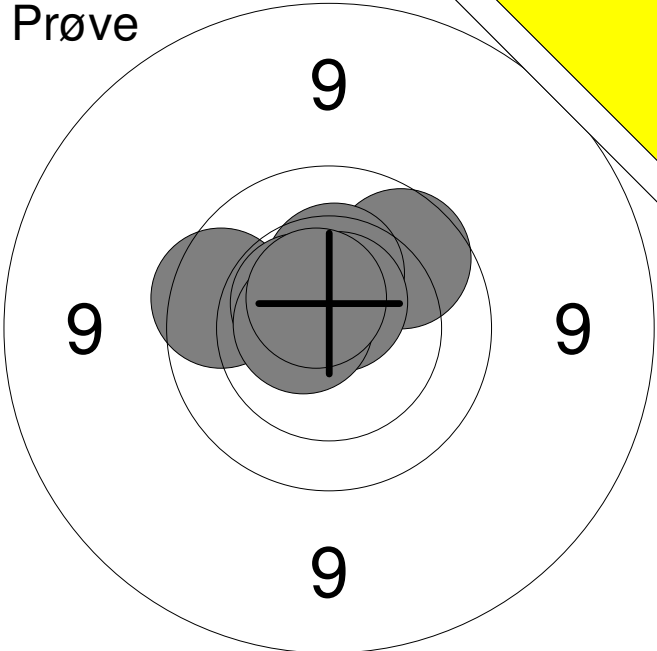
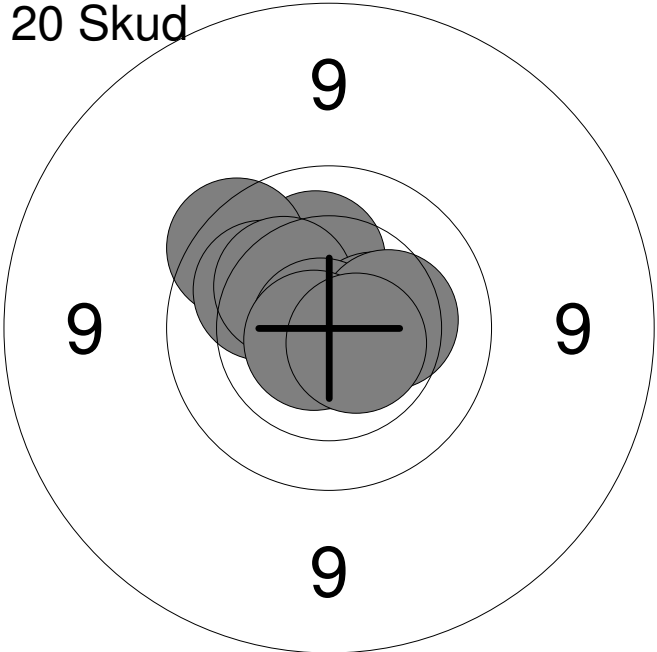
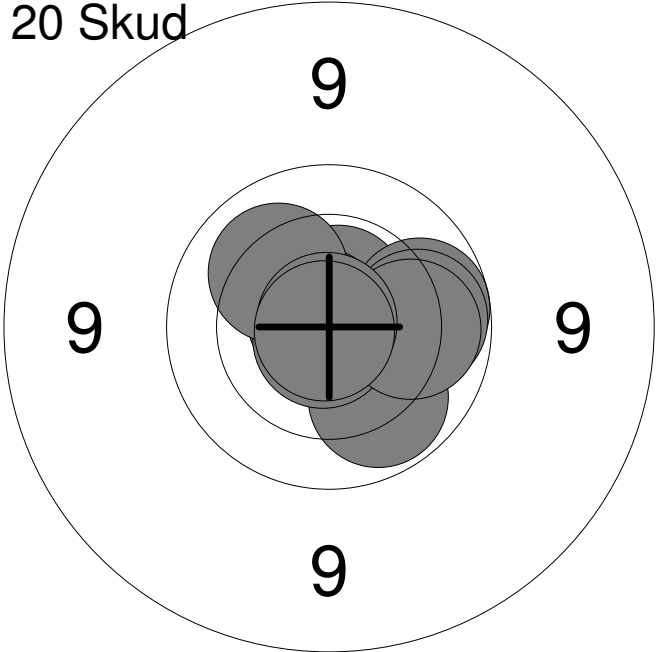
Hold	Skive	Brian Jensen		
75	10	Hobro Egnens Skytteforening		ÅK1
24.10.2013	15 meter riffelstævne 2013		Aalborg Skyttekreds	
Prøve		1:	9.8	←
		2:	9.9	↗
		3:	10.3	↑
		4:	10.7x	↗
		5:	10.5x	↗
		6:	10.7x	←
		7:	10.6x	↗
		Serie	68.0	
		Total	0.0	
20 Skud		1:	10.8x	↓
		2:	10.2	↑
		3:	9.8	↗
		4:	10.1	↗
		5:	10.3	↗
		6:	10.5	→
		7:	10.9x	←
		8:	10.3	→
		9:	10.7x	↖
		10:	10.6x	↘
		Serie	99.0	
		Total	99.0	
20 Skud		11:	10.6x	↑
		12:	10.8x	↗
		13:	9.9	→
		14:	10.0	↓
		15:	10.8x	↖
		16:	10.0	→
		17:	10.1	↗
		18:	10.1	→
		19:	10.9x	↗
		20:	10.9x	↖
		Serie	99.0	
		Total	198.0	

Hold 75	Skive 11	Mads Meulengracht	
-------------------	--------------------	--------------------------	--

15m	Mou & Omegns Skf.	MJ2	
-----	-------------------	-----	--

24.10.2013	15 meter riffelstævne 2013	Aalborg Skyttekreds	
------------	----------------------------	---------------------	--

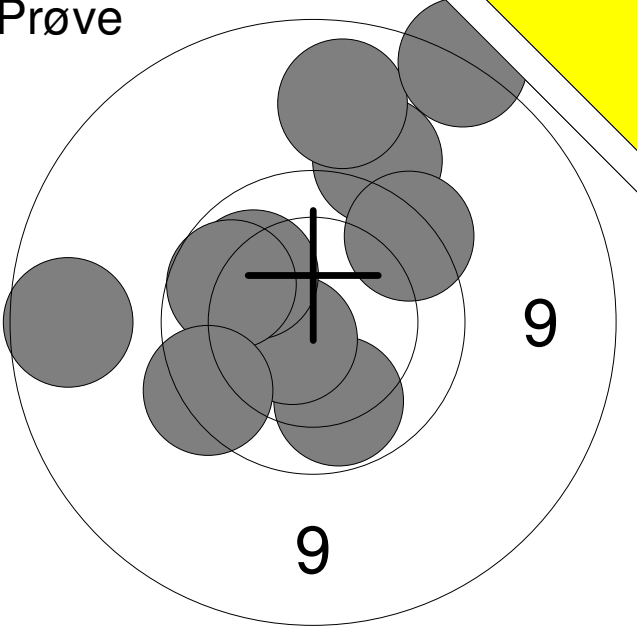
Prøve 	1:	10.0	↓
	2:	9.4	↑
	3:	9.1	↑
	4:	10.6x	↙
	5:	10.1	↗
	6:	9.9	↖
	7:	9.7	↙
	8:	9.7	↗
	9:	8.7	↗
	10:	8.9	←
	Serie		91.0
Total		0.0	

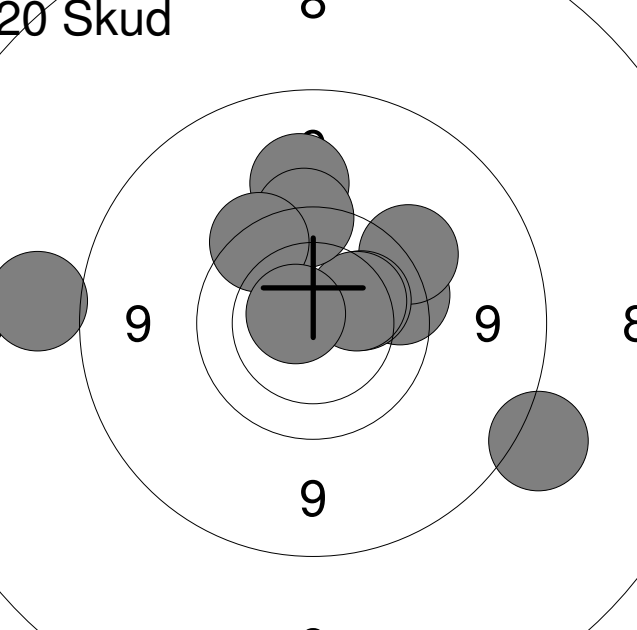
20 Skud 	1:	9.7	→
	2:	8.6	↘
	3:	9.3	↑
	4:	9.5	↗
	5:	10.1	→
	6:	10.2	↗
	7:	9.6	↑
	8:	8.4	←
	9:	9.7	↗
	10:	10.7x	↙
	Serie		91.0
Total		91.0	

20 Skud 	11:	10.7x	←
	12:	9.8	↑
	13:	9.9	↑
	14:	8.9	↗
	15:	9.3	↗
	16:	9.9	↗
	17:	9.2	↗
	18:	10.6x	↑
	19:	10.6x	↙
	20:	8.6	↗
	Serie		91.0
Total		182.0	

Hold 75	Skive 12	Sofie Kirketerp Nielsen	
-------------------	--------------------	--------------------------------	--

15m	Mou & Omegns Skf.	MB3
-----	-------------------	-----

24.10.2013	15 meter riffelstævne 2013	Aalborg Skyttekreds
------------	----------------------------	---------------------

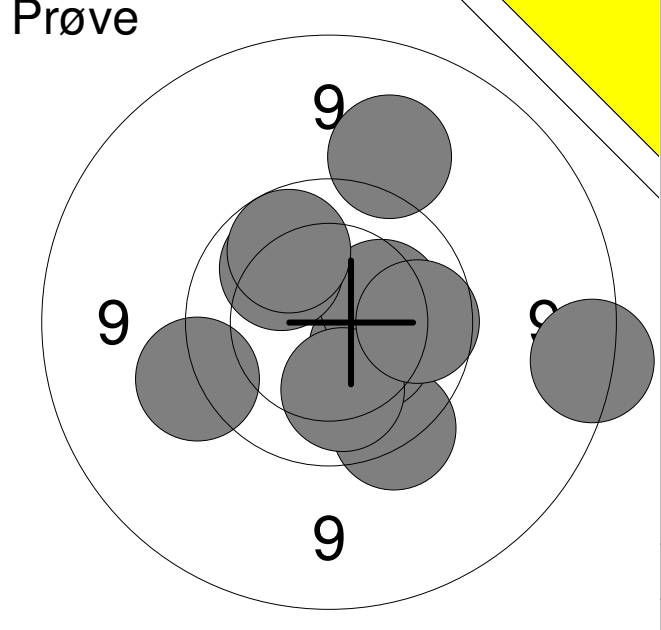
Prøve 	1:	9.7	↘
	2:	10.3	↘
	3:	8.8	→
	4:	9.5	↙
	5:	10.3	→
	6:	10.1	↗
	7:	10.1	↘
	8:	10.0	↗
	9:	9.9	→
	10:	9.3	↗
	Serie		94.0
Total		0.0	

20 Skud 	1:	10.0	↘
	2:	10.3	↘
	3:	10.5x	↘
	4:	9.7	←
	5:	10.5x	→
	6:	10.2	↘
	7:	9.7	↘
	8:	10.8x	↘
	9:	10.2	↘
	10:	9.2	↗
	Serie		97.0
Total		97.0	

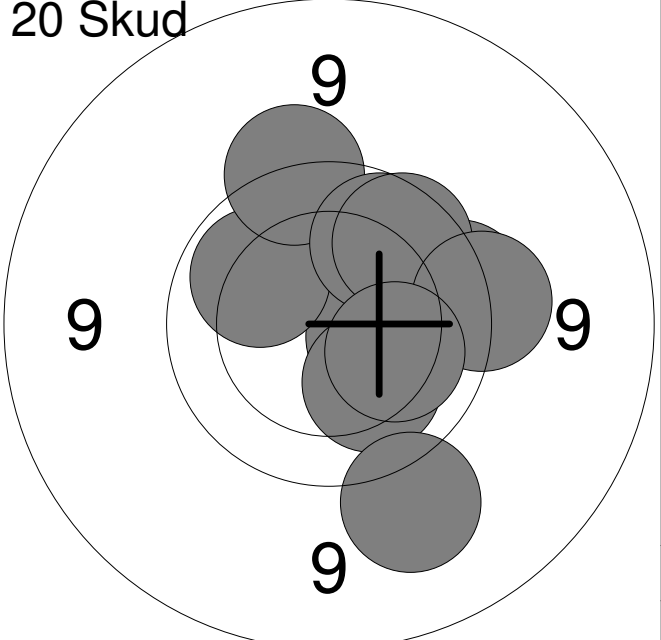
20 Skud 	11:	10.4	→
	12:	10.1	↗
	13:	9.7	→
	14:	9.6	↗
	15:	9.9	↗
	16:	9.8	↗
	17:	9.6	→
	18:	10.2	↘
	19:	9.3	↘
	20:	10.2	↘
	Serie		94.0
Total		191.0	

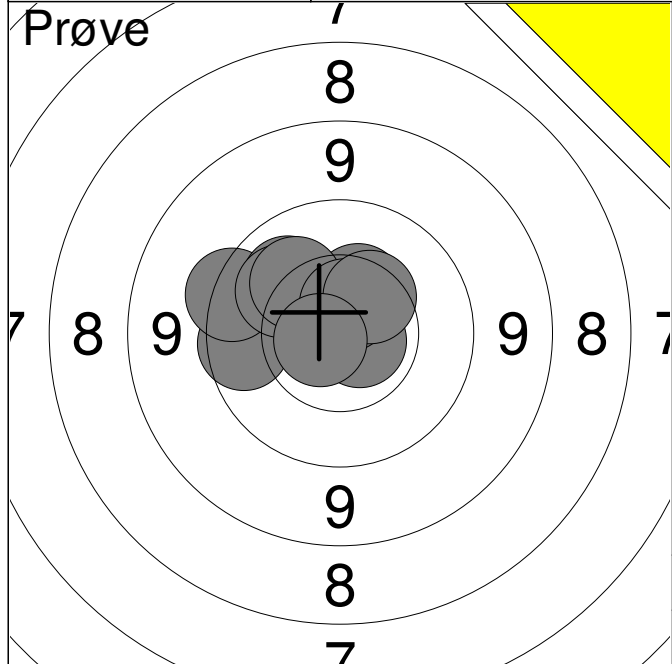

1:	10.7x	→
2:	9.8	←
3:	9.6	↖
4:	10.1	↗
5:	10.4	↗
6:	10.1	↗
7:	10.2	↗
8:	10.6x	↑
9:	10.4	↗
10:	10.7x	←
Serie		98.0
Total		0.0

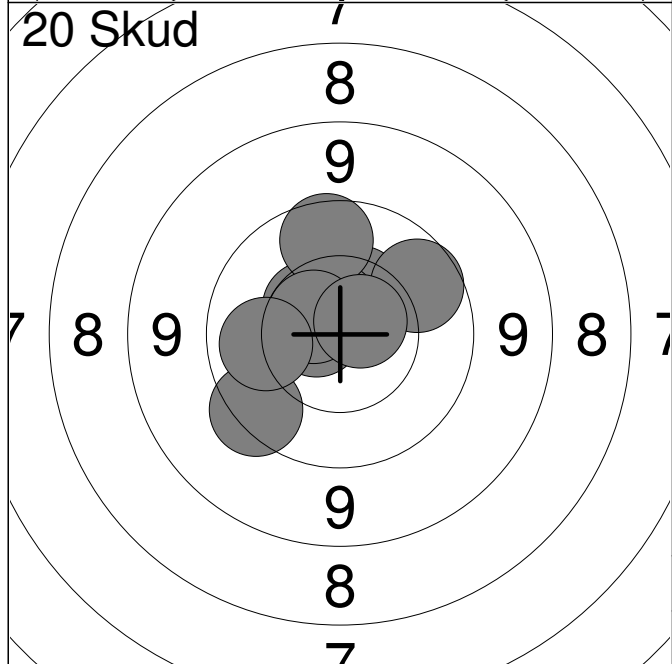

1:	10.4	↑
2:	10.7x	←
3:	10.5	↗
4:	10.6x	↑
5:	9.8	↑
6:	9.6	↖
7:	10.6	↗
8:	10.1	←
9:	9.9	↗
10:	10.7x	↗
Serie		97.0
Total		97.0

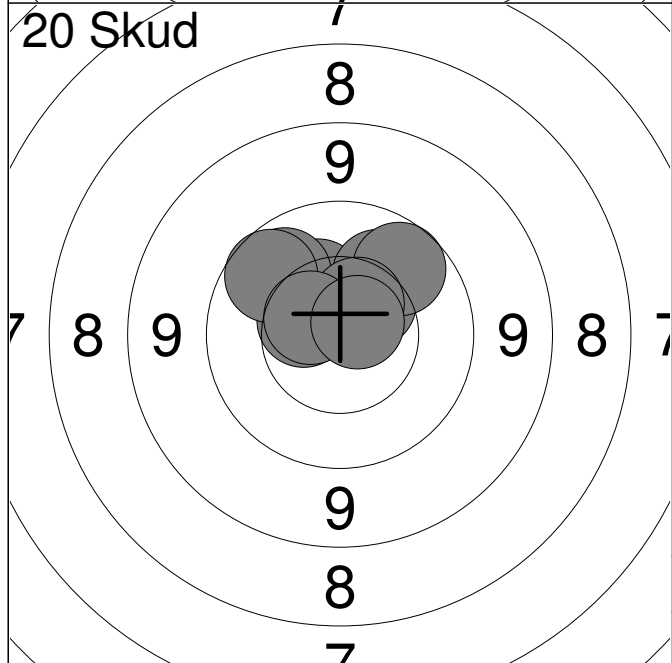

11:	10.5	←
12:	10.3	↑
13:	10.4	↗
14:	10.1	↗
15:	10.0	↗
16:	9.9	↗
17:	9.9	↗
18:	10.5	↑
19:	10.6	↖
20:	10.7x	↗
Serie		98.0
Total		195.0

Hold 76	Skive 2	Niels Kaasing	
-------------------	-------------------	----------------------	--

15m	Mou & Omegns Skf.	J2
-----	-------------------	----

24.10.2013	15 meter riffelstævne 2013	Aalborg Skyttekreds
------------	----------------------------	---------------------

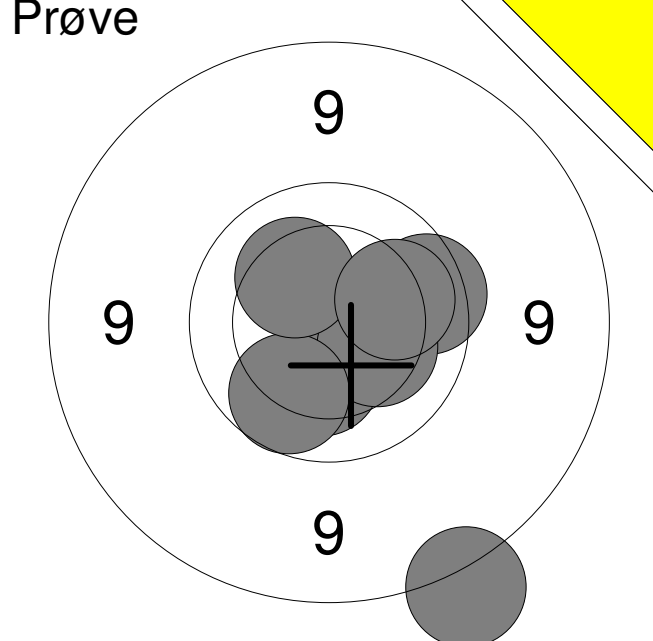
Prøve 	1:	8.6	↘
	2:	9.8	→
	3:	10.3	↘
	4:	10.3	↘
	5:	9.9	↘
	6:	10.2	↗
	7:	10.1	→
	Serie		
Total			0.0

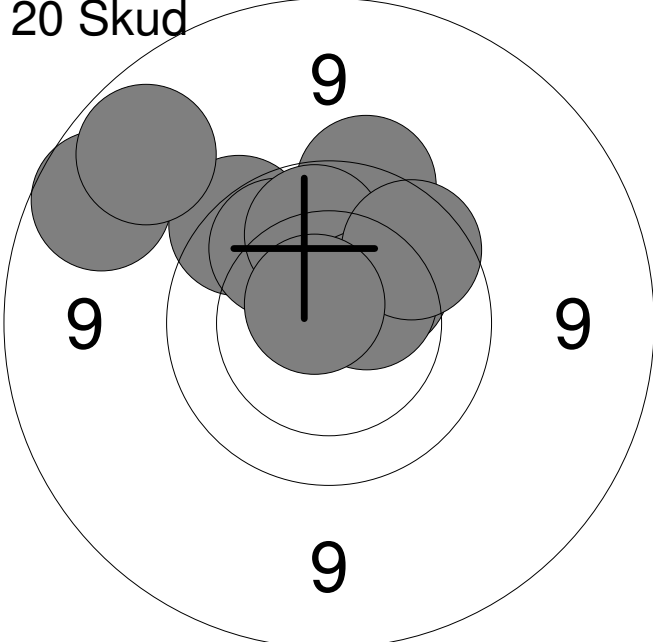
20 Skud 	1:	10.3	↗
	2:	9.7	↗
	3:	10.0	↗
	4:	9.6	↗
	5:	8.9	↗
	6:	10.0	↗
	7:	9.0	↗
	8:	10.5	↗
	9:	9.8	↗
	10:	10.7x	↗
Serie			94.0
Total			94.0

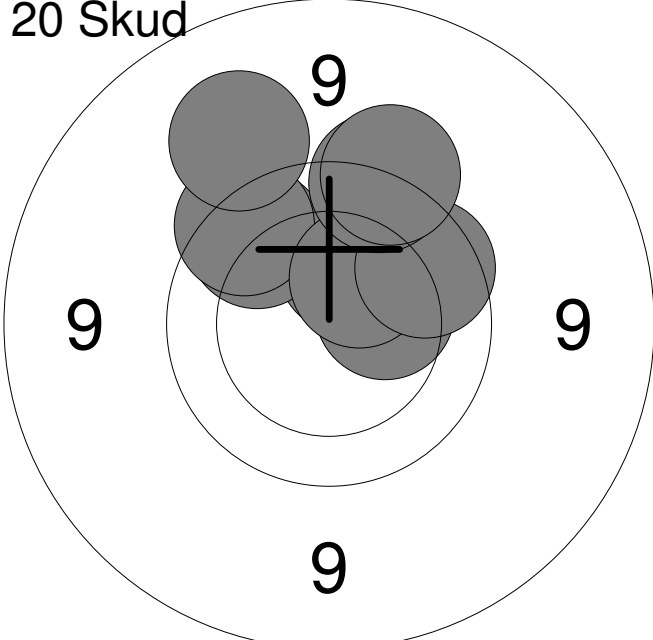
20 Skud 	11:	10.3	↗
	12:	10.3	→
	13:	9.8	↗
	14:	9.7	↗
	15:	9.9	↗
	16:	9.3	↗
	17:	10.4	↗
	18:	9.8	↗
	19:	9.6	↗
	20:	9.5	↗
Serie			93.0
Total			187.0

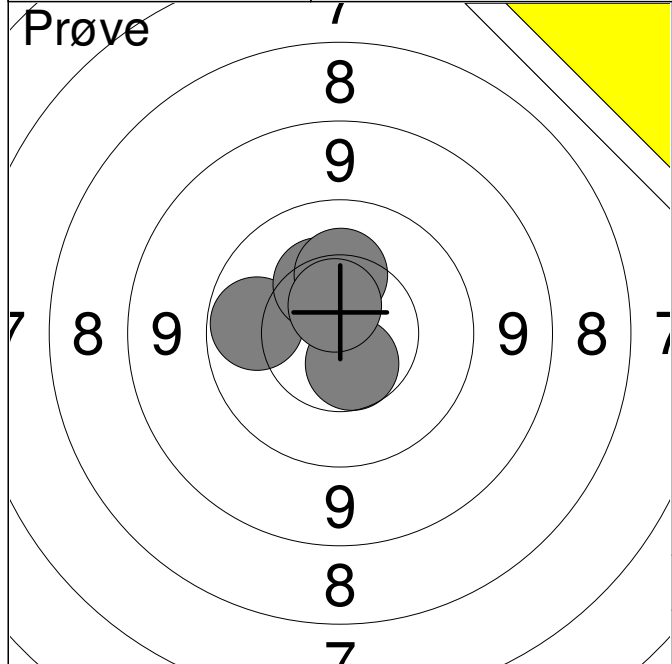

1:	10.0	←
2:	10.3	↑
3:	10.3	↑
4:	10.6	↓
5:	10.6x	↑
Serie		50.0
Total		0.0

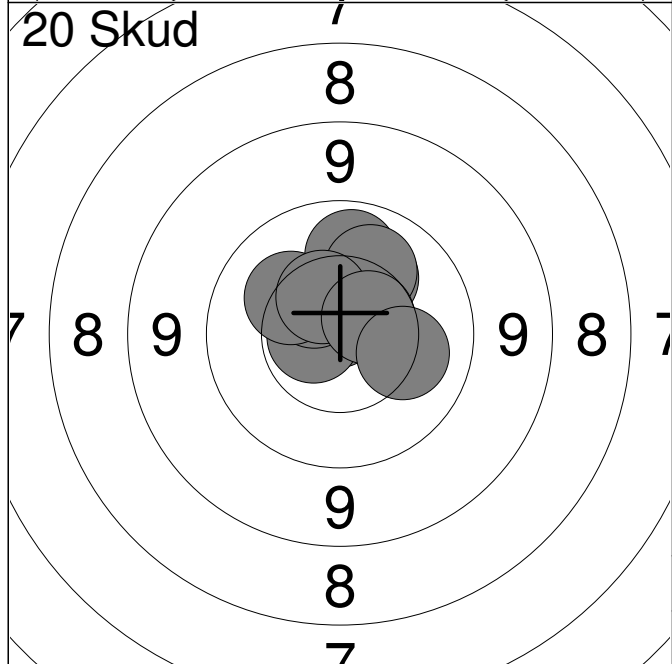

1:	10.0	↑
2:	10.8x	↑
3:	10.6x	←
4:	10.2	↗
5:	10.1	↗
6:	10.5	↗
7:	10.2	↗
8:	10.5	↗
9:	10.6	↗
10:	10.2	→
Serie		100.0
Total		100.0

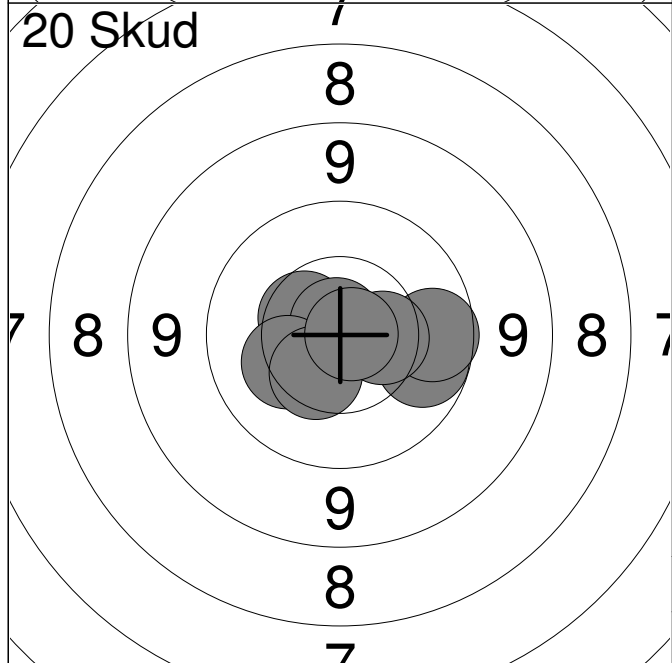

11:	10.9x	↗
12:	9.9	→
13:	9.9	→
14:	10.6x	↖
15:	10.5	↗
16:	10.8x	↑
17:	10.3	↖
18:	10.5	→
19:	10.4	↖
20:	10.8x	→
Serie		98.0
Total		198.0

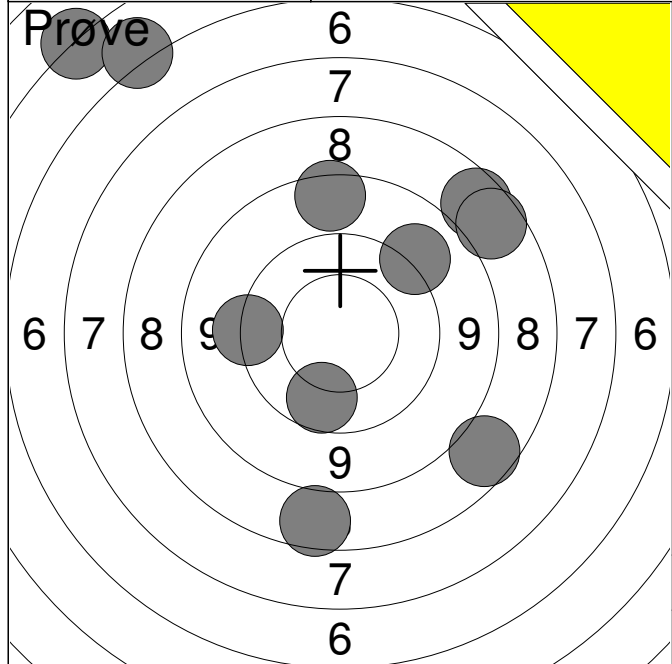

1:	8.7	↑
2:	9.3	↗
3:	4.4	↗
4:	9.9	↓
5:	7.8	↗
6:	7.8	↓
7:	7.9	↗
8:	9.5	←
9:	5.2	↗
10:	7.9	↓
Serie		72.0
Total		0.0

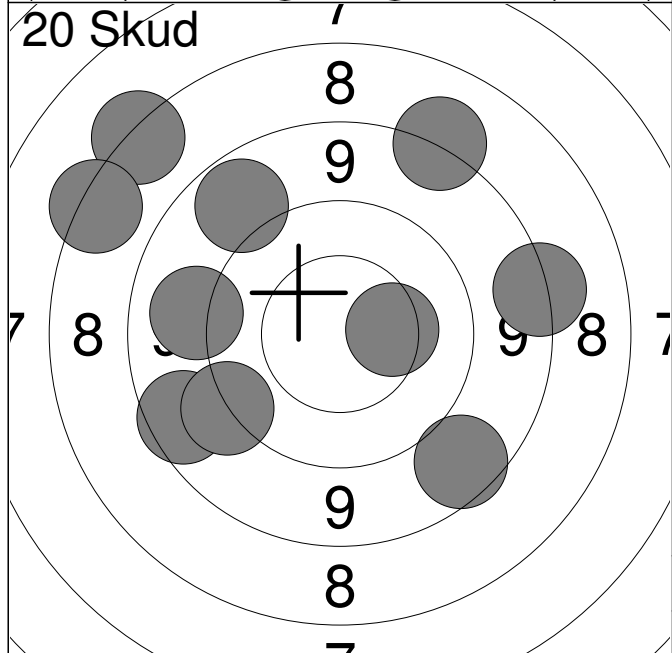

1:	9.2	←
2:	8.8	←
3:	7.5	↗
4:	9.0	↗
5:	8.8	↓
6:	8.3	↗
7:	9.3	←
8:	7.5	↗
9:	10.3	→
10:	8.4	→
Serie		83.0
Total		83.0

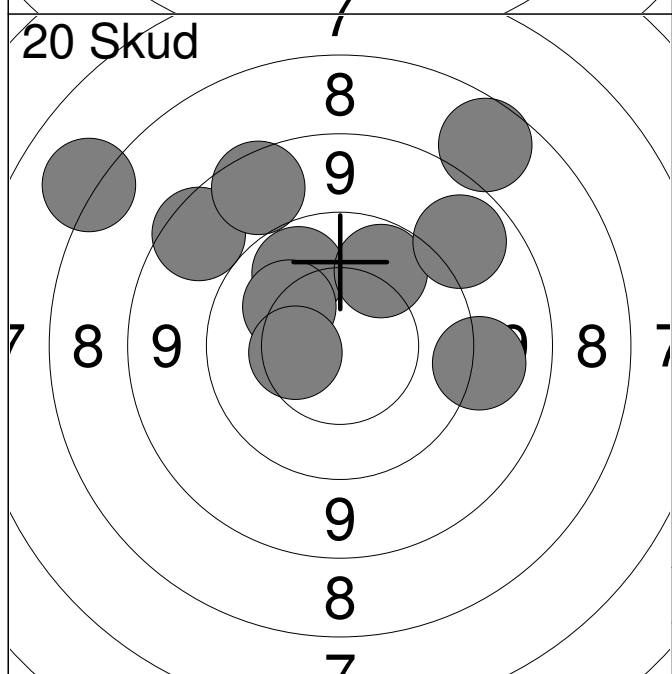

11:	10.0	↗
12:	9.3	→
13:	8.8	↗
14:	7.9	↗
15:	10.0	↗
16:	7.3	↗
17:	10.2	↗
18:	8.8	↗
19:	9.0	↗
20:	10.4	←
Serie		88.0
Total		171.0

Hold 76	Skive 5	Richard Jensen
-------------------	-------------------	-----------------------

15m	Mou & Omegns Skf.	MÅ3
-----	-------------------	-----

24.10.2013	15 meter riffelstævne 2013	Aalborg Skyttekreds
------------	----------------------------	---------------------

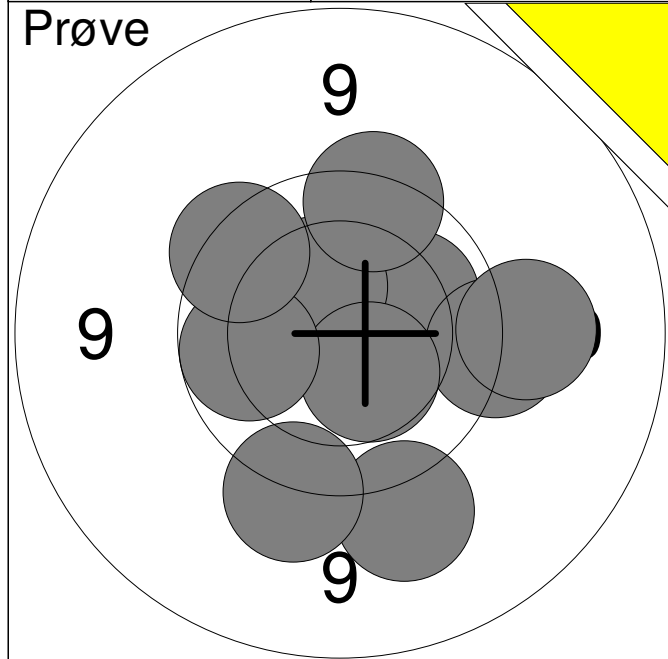

1:	9.4	↓
2:	9.5	↓
3:	10.1	→
4:	9.6	→
5:	10.4	↑
6:	9.7	↑
7:	9.4	→
8:	10.4	↓
9:	10.0	←
10:	9.7	↑
Serie	94.0	
Total	0.0	

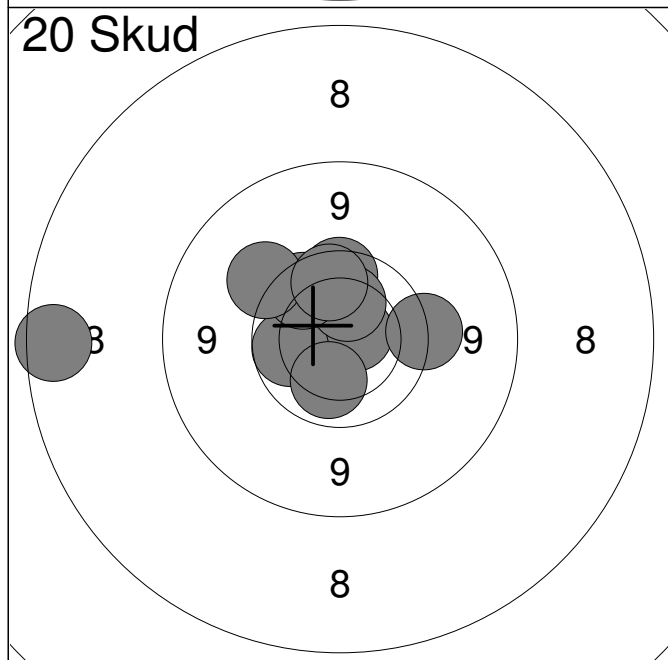

1:	9.8	↑
2:	10.6x	→
3:	9.9	←
4:	10.2	↑
5:	9.8	↑
6:	7.9	←
7:	9.6	→
8:	10.1	↓
9:	9.4	↑
10:	9.9	↑
Serie	91.0	
Total	91.0	

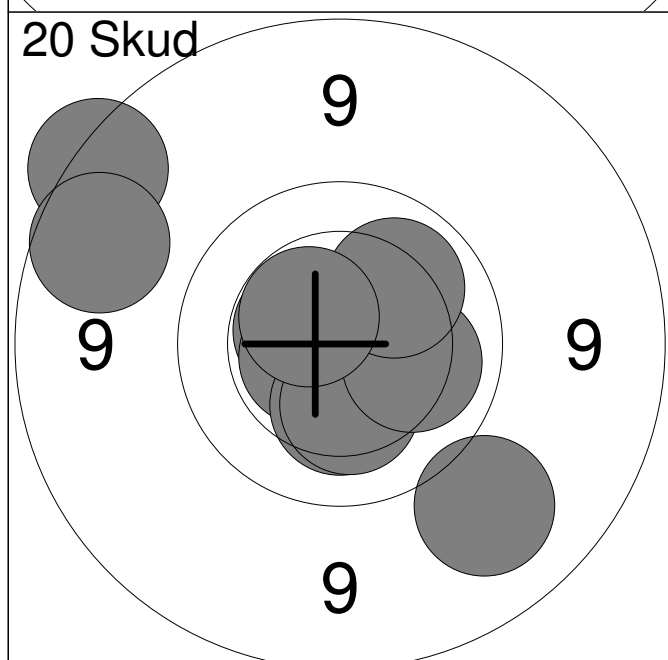

11:	10.5x	←
12:	10.6x	←
13:	10.3	↓
14:	8.8	↑
15:	10.3	↓
16:	10.1	→
17:	10.1	↑
18:	8.9	↑
19:	10.5x	↑
20:	9.2	↓
Serie	95.0	
Total	186.0	

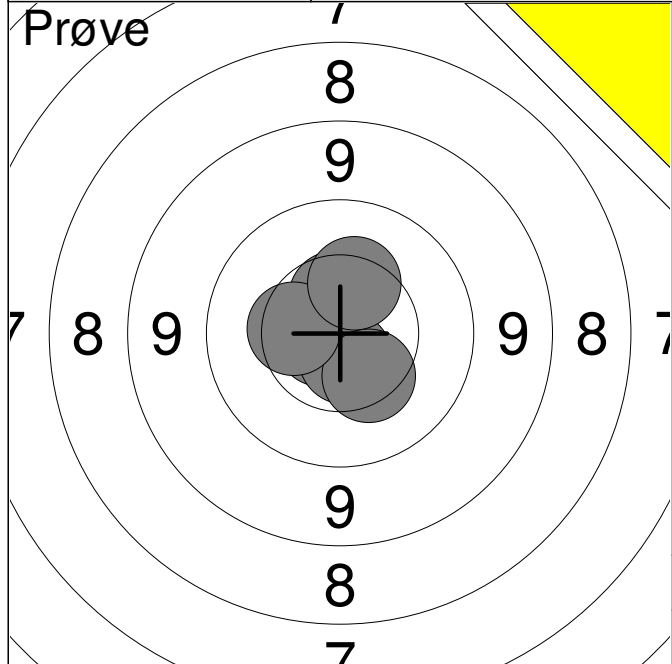

1:	10.7x	←
2:	10.5	↑
3:	10.7x	↓
4:	10.4	↓
5:	10.4	←
6:	10.3	↑
Serie		60.0
Total		0.0

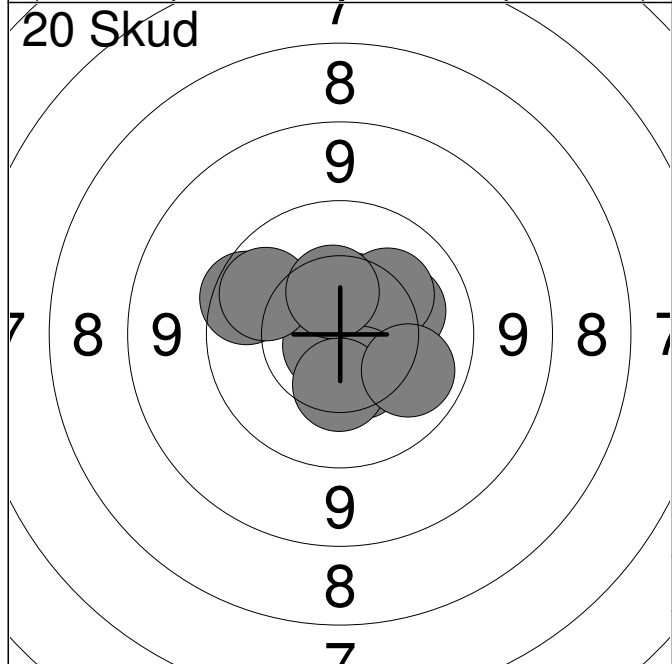

1:	9.8	←
2:	10.8x	↙
3:	10.0	↖
4:	10.2	→
5:	10.5	↑
6:	10.2	↗
7:	10.5	↓
8:	10.4	↓
9:	10.1	→
10:	10.5	↑
Serie		99.0
Total		99.0

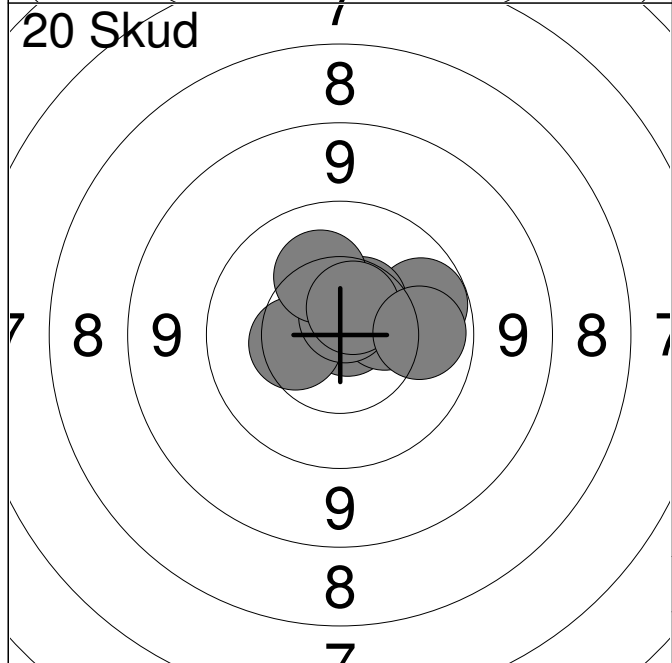

11:	10.8x	↗
12:	10.4	←
13:	10.4	→
14:	10.6x	↑
15:	10.0	→
16:	10.5	↗
17:	10.7x	↑
18:	10.2	↖
19:	10.6x	↑
20:	10.0	→
Serie		100.0
Total		199.0

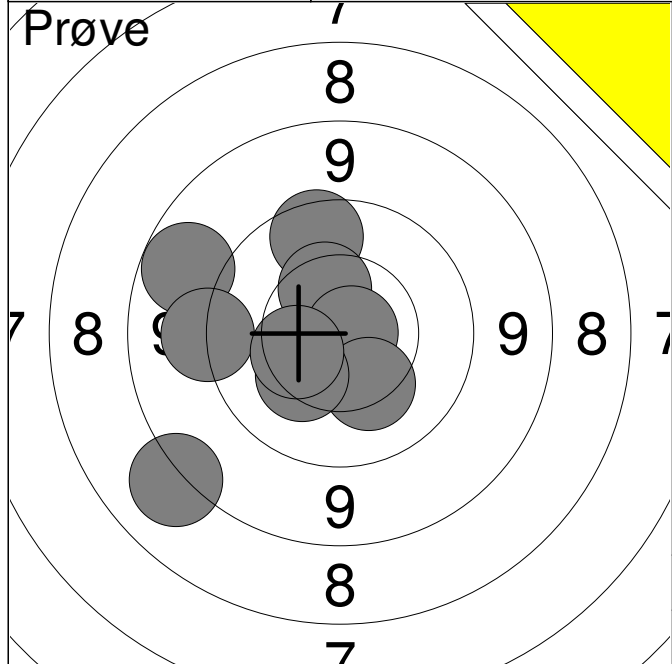

1:	9.0	↖
2:	9.8	↑
3:	10.4	↑
4:	10.8x	→
5:	9.4	↖
6:	10.3	↓
7:	8.2	↙
8:	10.3	↙
9:	10.4	↙
Serie		85.0
Total		0.0

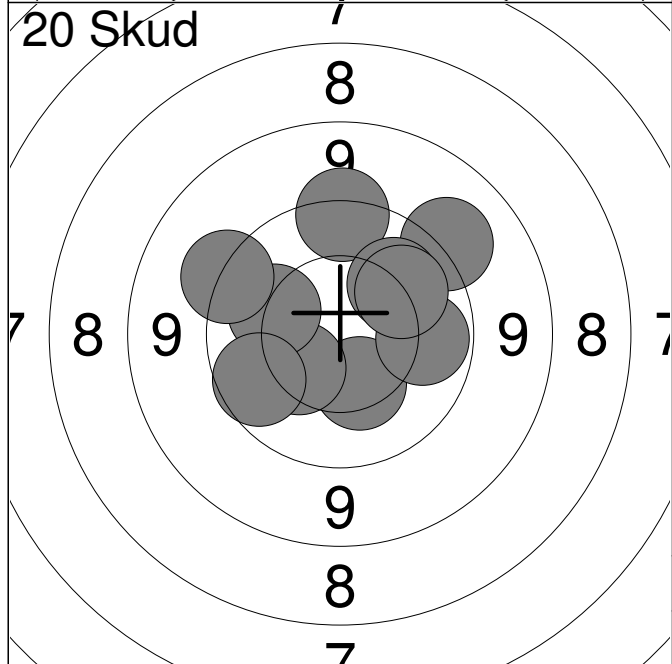

1:	10.3	↓
2:	10.3	↙
3:	10.1	↖
4:	9.4	↖
5:	9.9	↙
6:	10.0	→
7:	9.5	↑
8:	9.3	↗
9:	10.1	↗
10:	10.1	↗
Serie		96.0
Total		96.0

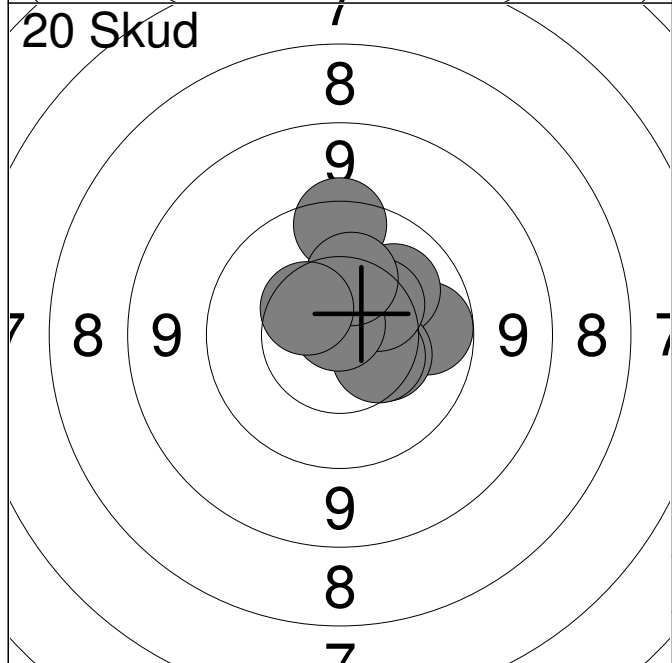

11:	9.9	→
12:	10.7x	→
13:	10.1	↗
14:	10.4	→
15:	9.6	↑
16:	10.4	→
17:	10.4	↗
18:	10.8x	↑
19:	10.3	↑
20:	10.5	↖
Serie		98.0
Total		194.0

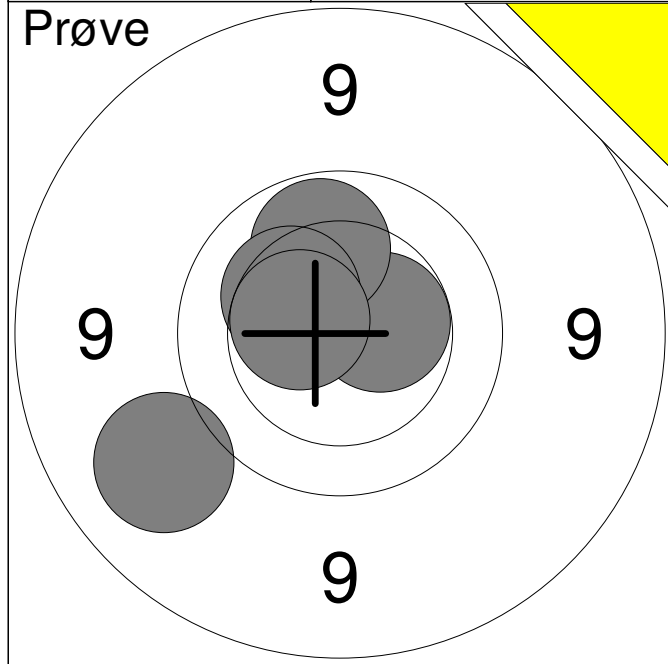

1:	9.2	↙
2:	10.5x	→
3:	10.0	↑
4:	10.3	↗
5:	10.5x	↖
Serie		49.0
Total		0.0

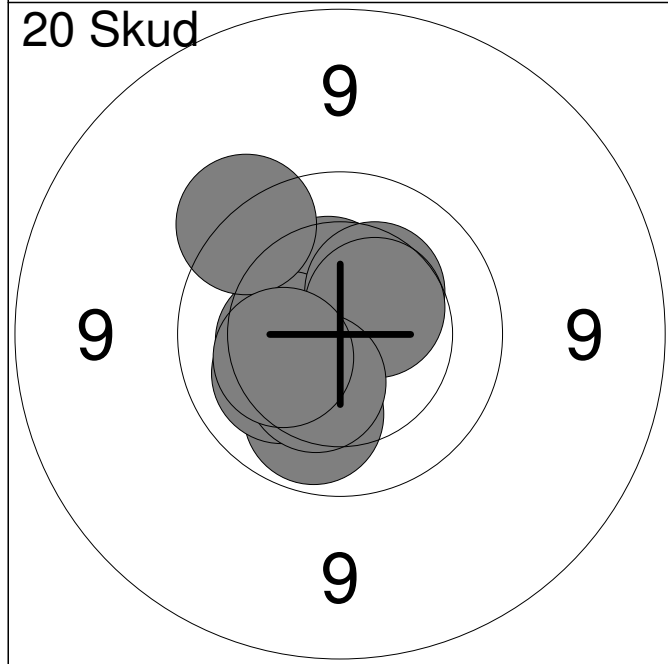

1:	10.0	↘
2:	10.5	↗
3:	10.4	↑
4:	10.4	←
5:	10.4	↗
6:	10.5	↗
7:	10.2	↙
8:	10.4	↘
9:	9.6	↗
10:	10.3	↙
Serie		99.0
Total		99.0

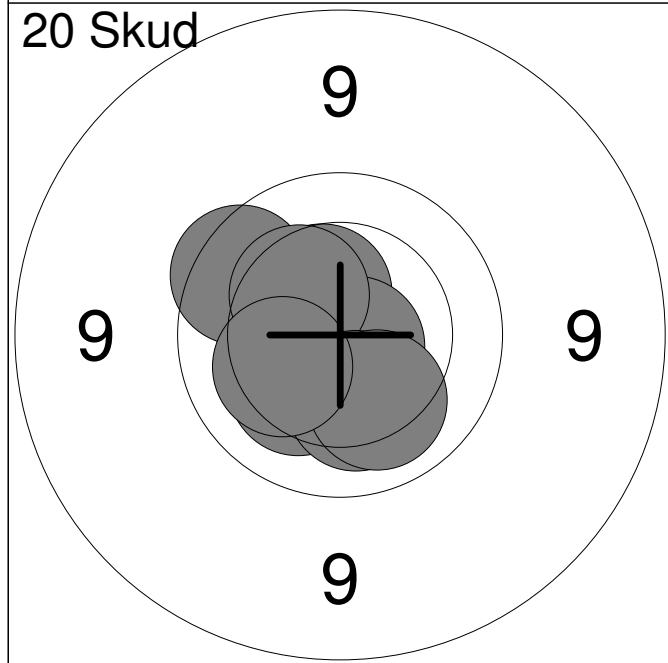

11:	10.5	↗
12:	10.3	↗
13:	10.6x	↘
14:	9.8	↗
15:	10.2	↘
16:	10.8x	↘
17:	10.3	↗
18:	10.2	↘
19:	10.1	↘
20:	10.2	↙
Serie		99.0
Total		198.0

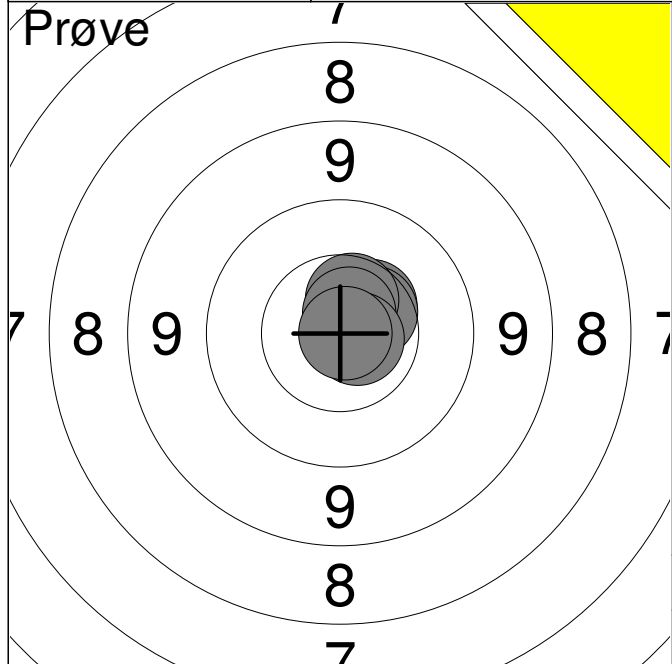

1:	10.5	↗
2:	10.5	↗
3:	10.5	↑
4:	10.7x	↑
5:	10.7x	→
6:	10.9x	→
Serie		60.0
Total		0.0

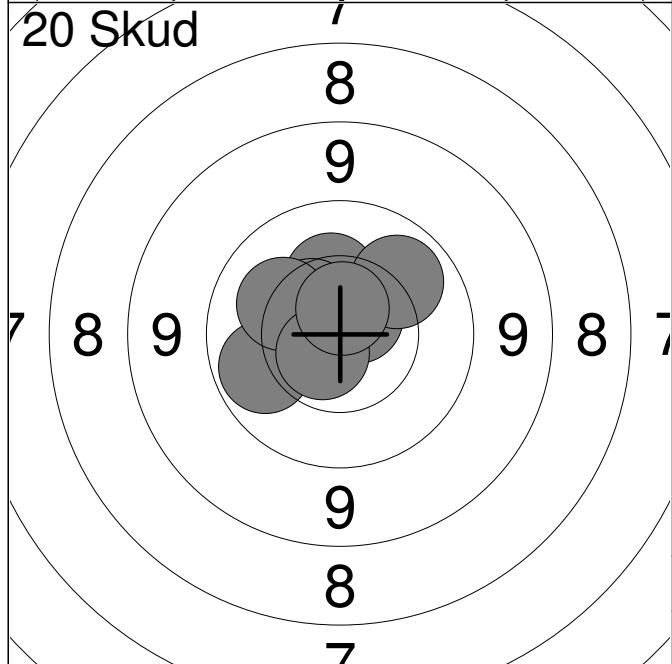

1:	10.7x	↗
2:	10.6x	↖
3:	10.6x	↖
4:	10.0	↖
5:	10.3	↑
6:	10.5	↗
7:	10.2	↖
8:	10.7x	↖
9:	10.1	↗
10:	10.6x	↑
Serie		100.0
Total		100.0

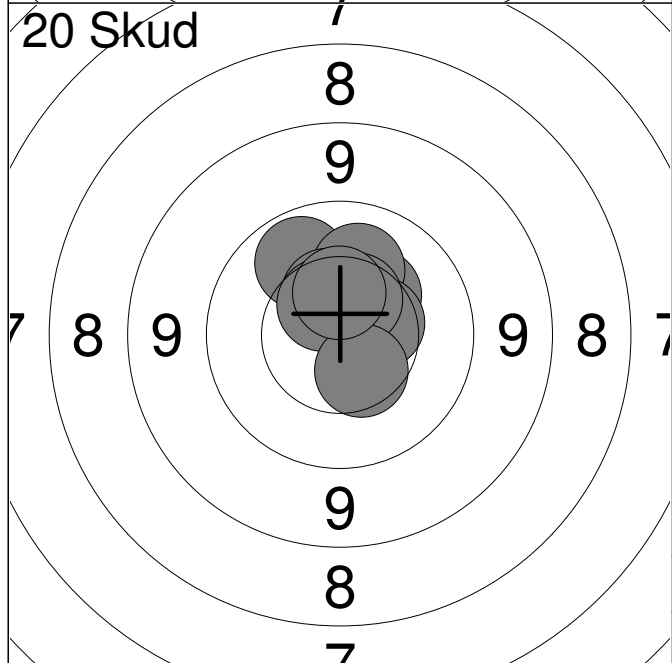

11:	10.0	↖
12:	10.6	↑
13:	10.3	↗
14:	10.2	↑
15:	10.5	→
16:	10.5	↗
17:	10.5	↑
18:	10.6	↗
19:	10.5	↘
20:	10.5	↑
Serie		100.0
Total		200.0

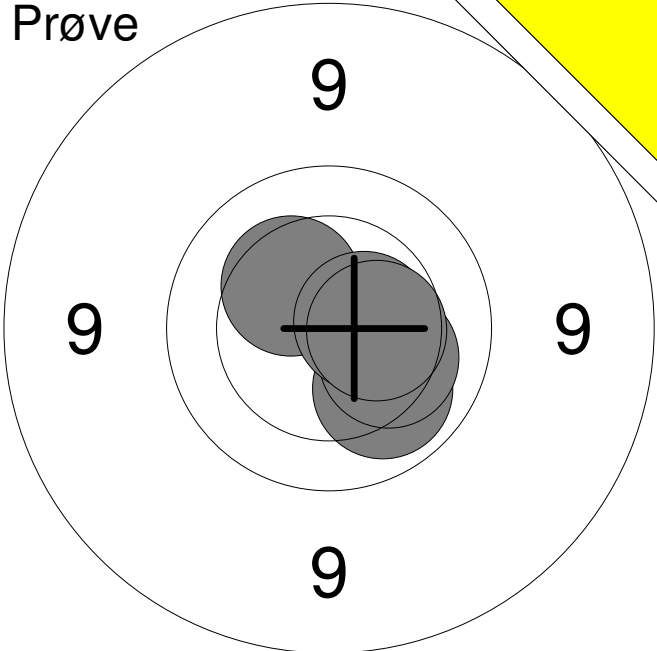
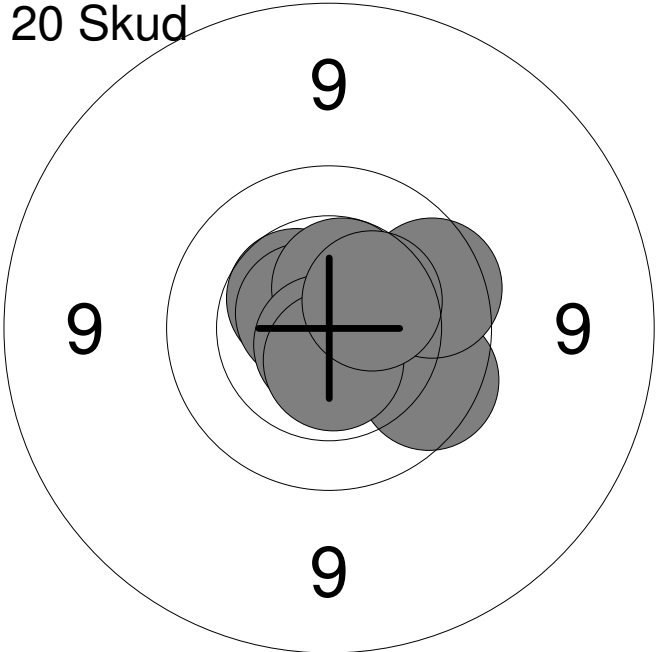
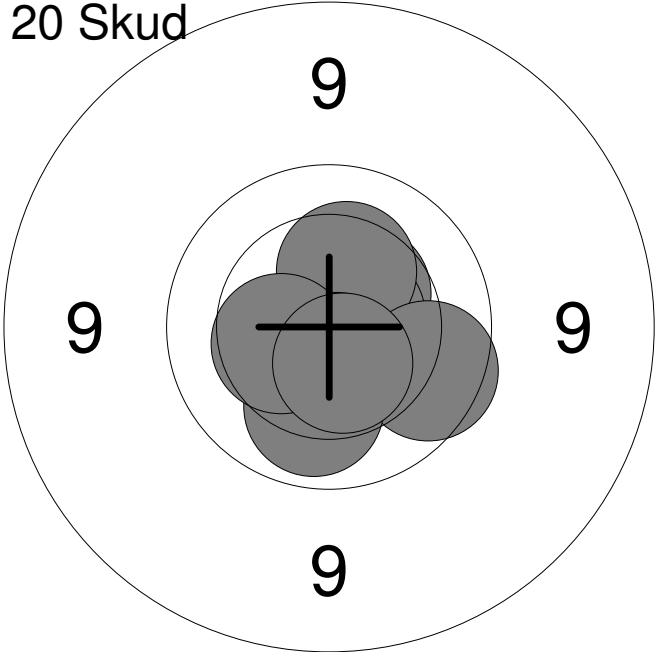
Hold	Skive	Brian Jensen	
76	10		
15m	Hobro Egnens Skytteforening		MÅ1
24.10.2013	15 meter riffelstævne 2013	Aalborg Skyttekreds	
Prøve		1: 10.1 ↘	
		2: 10.2 ↘	
		3: 10.3 ↗	
		4: 10.6x →	
		5: 10.4 →	
	Serie	50.0	
	Total	0.0	
20 Skud		1: 10.6x →	
		2: 9.8 ↘	
		3: 9.8 →	
		4: 10.9x →	
		5: 10.5 ↗	
		6: 10.6x ↗	
		7: 10.5x ↑	
		8: 10.8x ↓	
		9: 10.6x ↓	
		10: 10.4 ↗	
	Serie	98.0	
	Total	98.0	
20 Skud		11: 10.5 ↗	
		12: 10.7x →	
		13: 10.6x →	
		14: 10.3 ↑	
		15: 9.9 ↘	
		16: 10.5x ↓	
		17: 10.6x ↓	
		18: 10.1 ↓	
		19: 10.4 ←	
		20: 10.5x ↓	
	Serie	99.0	
	Total	197.0	

Hold 76	Skive 11	Arne Larsen
-------------------	--------------------	--------------------

15m	Vilsted Skf.	V3
-----	--------------	----

24.10.2013	15 meter riffelstævne 2013	Aalborg Skyttekreds
------------	----------------------------	---------------------

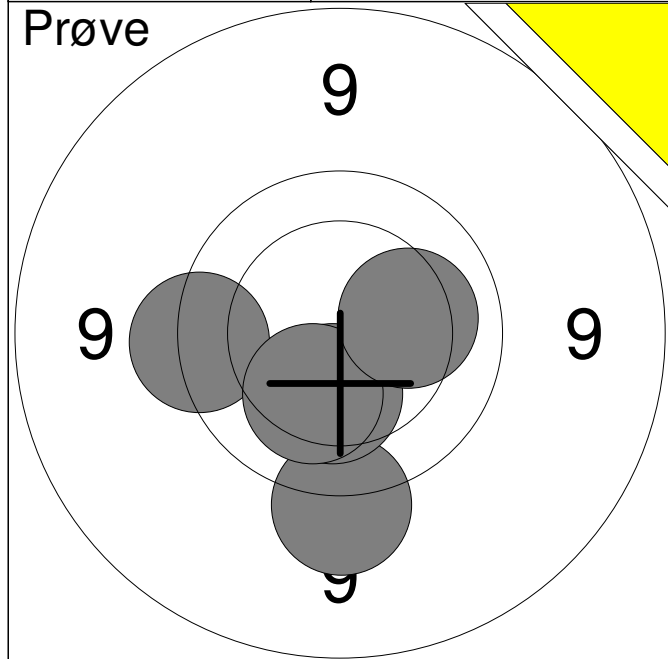

1:	9.5	↓
2:	9.6	←
3:	10.3	↓
4:	10.2	↓
5:	10.2	→
Serie	48.0	
Total	0.0	

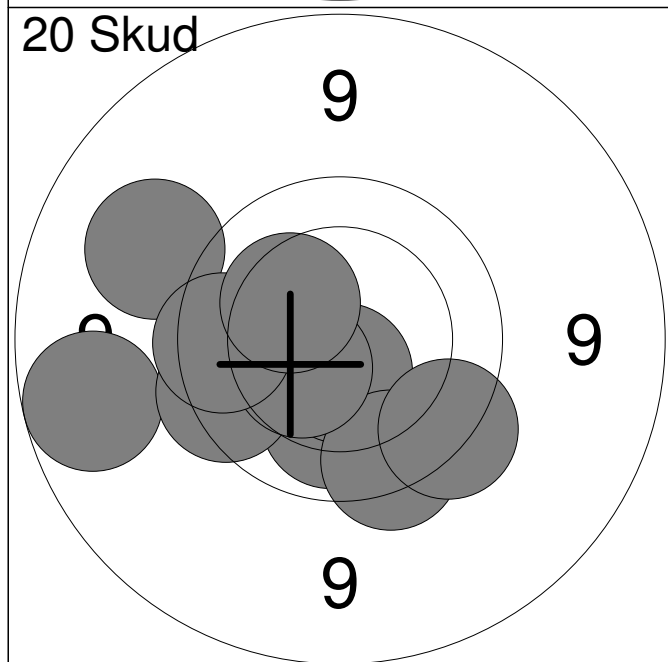

1:	9.0	←
2:	10.1	↓
3:	10.6x	↓
4:	9.7	↓
5:	9.7	↓
6:	9.7	←
7:	10.4	←
8:	9.3	↗
9:	9.8	←
10:	10.3	↗
Serie	94.0	
Total	94.0	

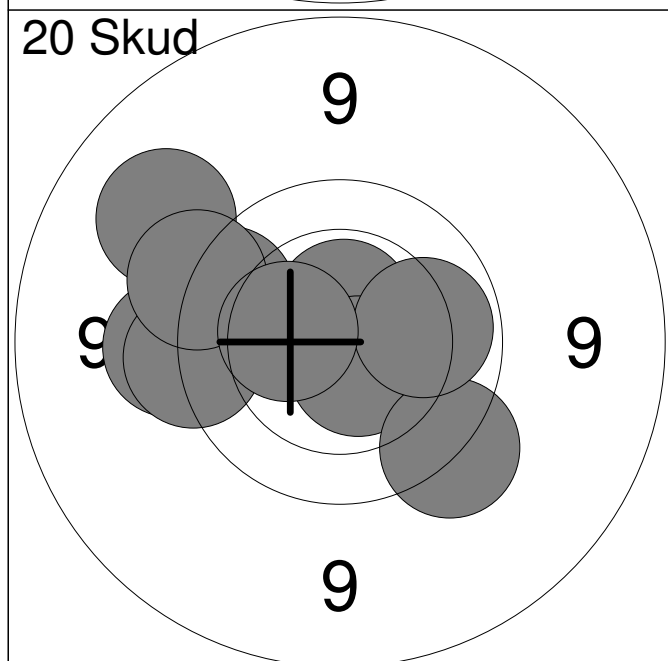

11:	9.5	←
12:	9.2	↗
13:	10.6x	↑
14:	10.6x	↓
15:	9.6	↓
16:	9.8	↗
17:	10.0	→
18:	9.6	←
19:	9.6	↗
20:	10.4	←
Serie	94.0	
Total	188.0	

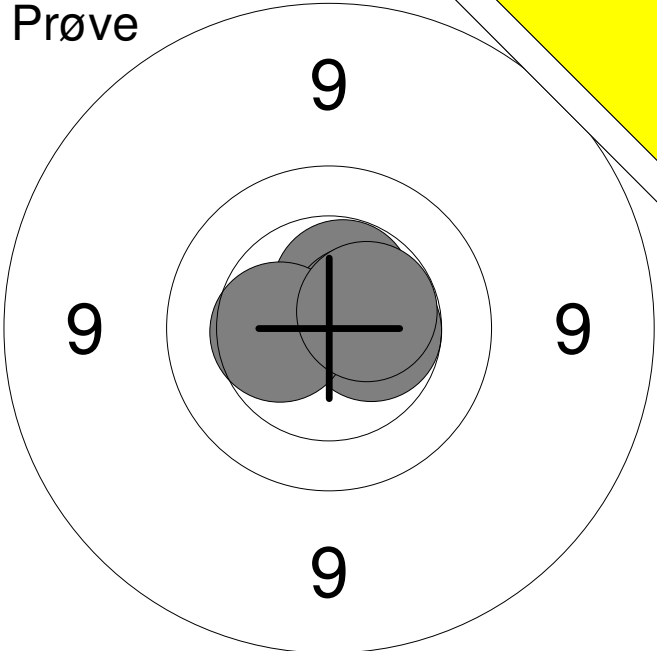
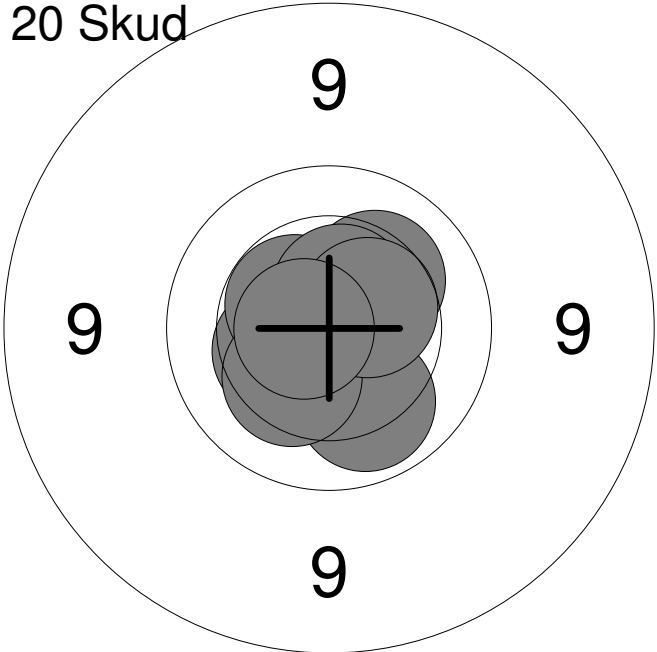
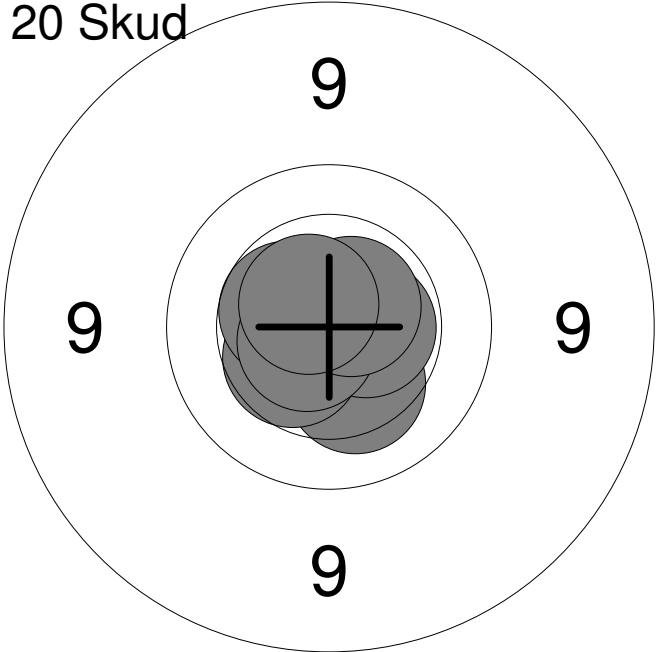
Hold	Skive	Knud Møller	
77	1		
15m	Samsø Skytteforening	V1	
24.10.2013	15 meter riffelstævne 2013	Aalborg Skyttekreds	
Prøve		1: 10.5x	↗
		2: 10.6x	→
		3: 10.5x	→
		4: 10.4	←
		5: 10.5x	↗
		Serie	50.0
		Total	0.0
20 Skud		1: 10.5	↗
		2: 10.1	↘
		3: 10.2	↗
		4: 10.8x	↖
		5: 10.4	↙
		6: 10.5x	↖
		7: 10.3	↘
		8: 10.6x	↗
		9: 10.5	→
		10: 10.7x	←
		Serie	100.0
		Total	100.0
20 Skud		11: 10.9x	↗
		12: 10.3	↘
		13: 10.7x	↖
		14: 10.7x	→
		15: 10.4	↙
		16: 10.5x	→
		17: 10.5	↖
		18: 10.7x	↙
		19: 10.6x	↗
		20: 10.6x	↖
		Serie	100.0
		Total	200.0

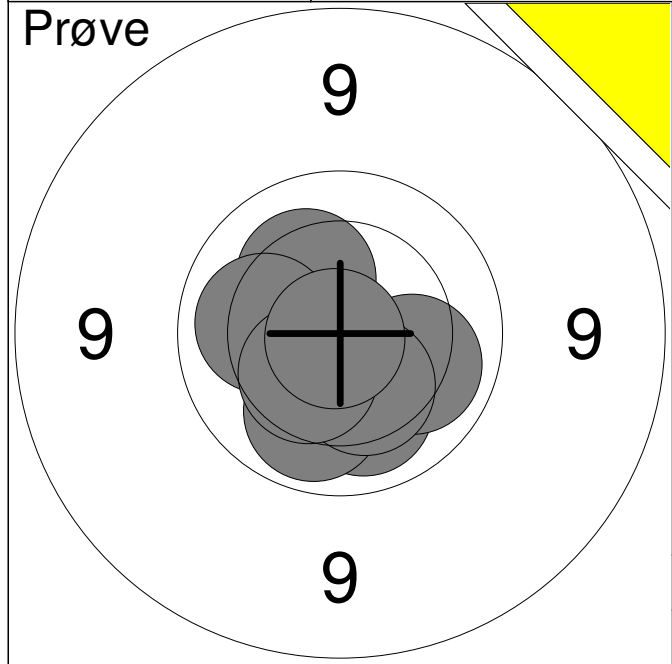

1:	10.1	↘
2:	10.1	→
3:	10.7x	←
4:	10.1	↘
5:	10.3	↗
6:	10.1	←
7:	10.3	↘
8:	10.4	↘
9:	10.9x	↘
Serie		90.0
Total		0.0

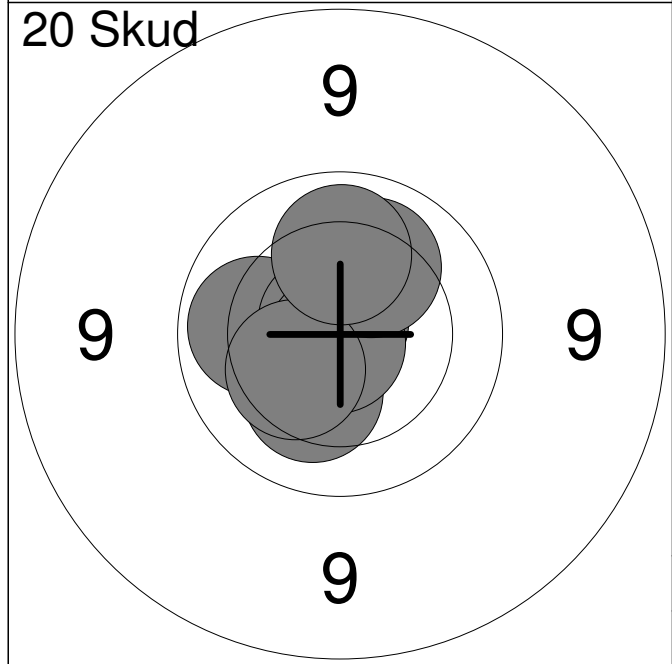

1:	10.7x	↙
2:	10.8x	↑
3:	10.6x	↑
4:	10.3	↘
5:	10.1	←
6:	10.8x	↗
7:	10.8x	↘
8:	10.2	↑
9:	10.3	↙
10:	10.1	↑
Serie		100.0
Total		100.0

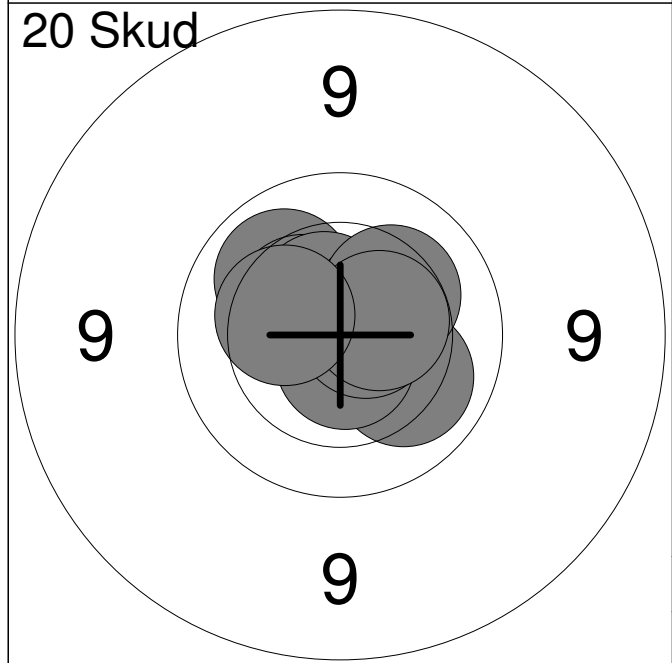

11:	10.1	↗
12:	10.4	↗
13:	10.6x	↗
14:	10.1	↘
15:	10.7x	↘
16:	10.5	↗
17:	10.7x	→
18:	10.2	↗
19:	10.5x	→
20:	10.3	←
Serie		100.0
Total		200.0

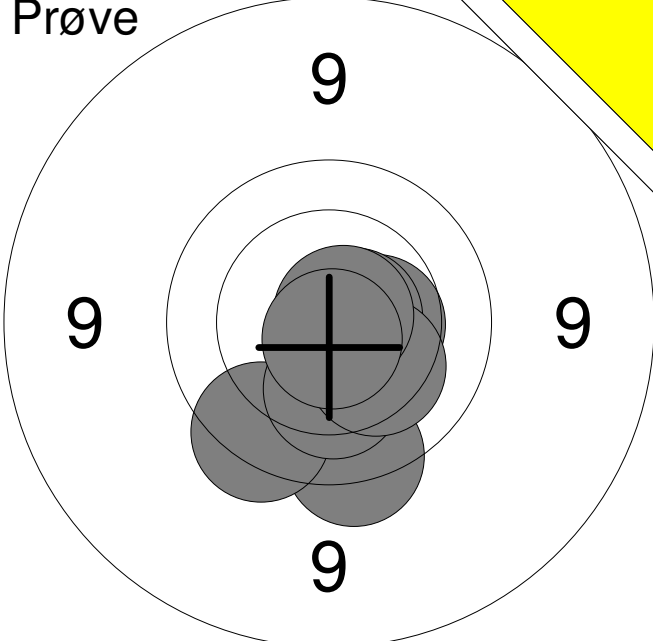
Prøve 	1:	9.7	↓	
	2:	9.7	↙	
	3:	10.2	↓	
	4:	10.5	→	
	5:	10.7x	→	
	6:	10.3	↙	
	7:	10.8x	↗	
	8:	10.8x	↓	
	Serie		78.0	
	Total		0.0	

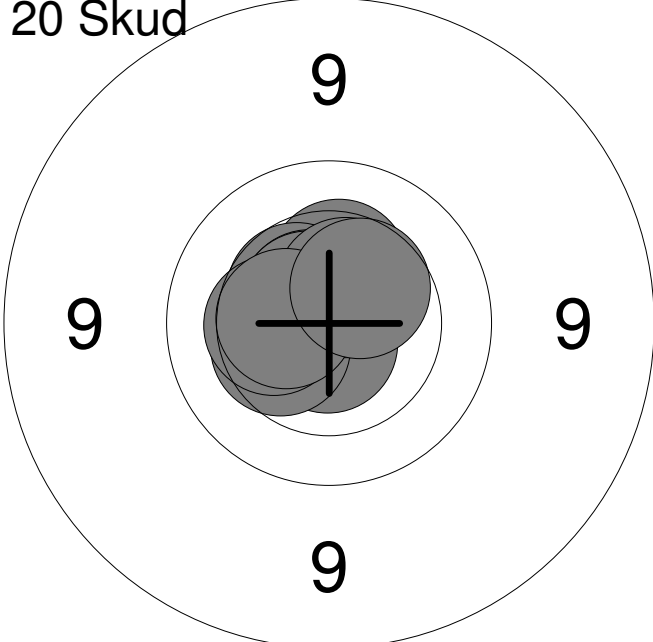
20 Skud 	1:	10.7x	↓
	2:	10.4	↑
	3:	10.5	↗
	4:	10.6x	↗
	5:	10.6x	↗
	6:	10.4	↙
	7:	10.4	←
	8:	10.5x	↑
	9:	10.5	←
	10:	10.4	↗
	Serie		100.0
Total		100.0	

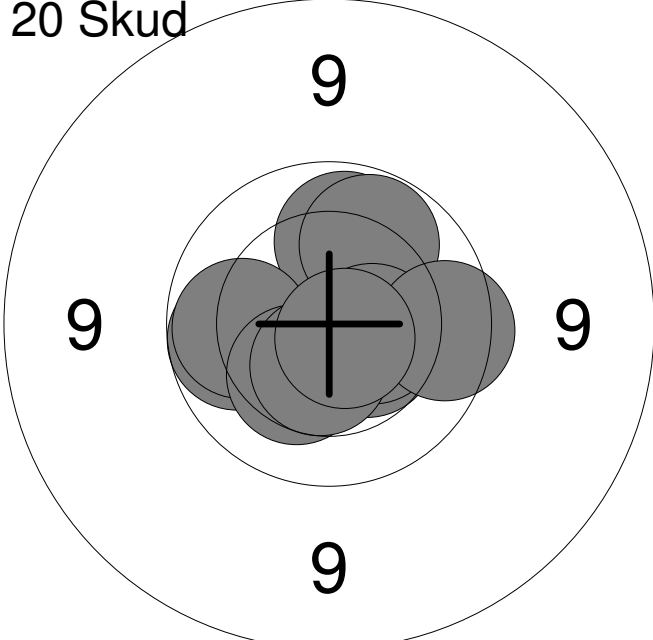
20 Skud 	11:	10.0	↑
	12:	10.0	↗
	13:	10.5	↘
	14:	10.5	→
	15:	9.8	→
	16:	9.9	←
	17:	10.0	←
	18:	10.3	↙
	19:	10.5	↓
	20:	10.7x	↘
	Serie		98.0
Total		198.0	

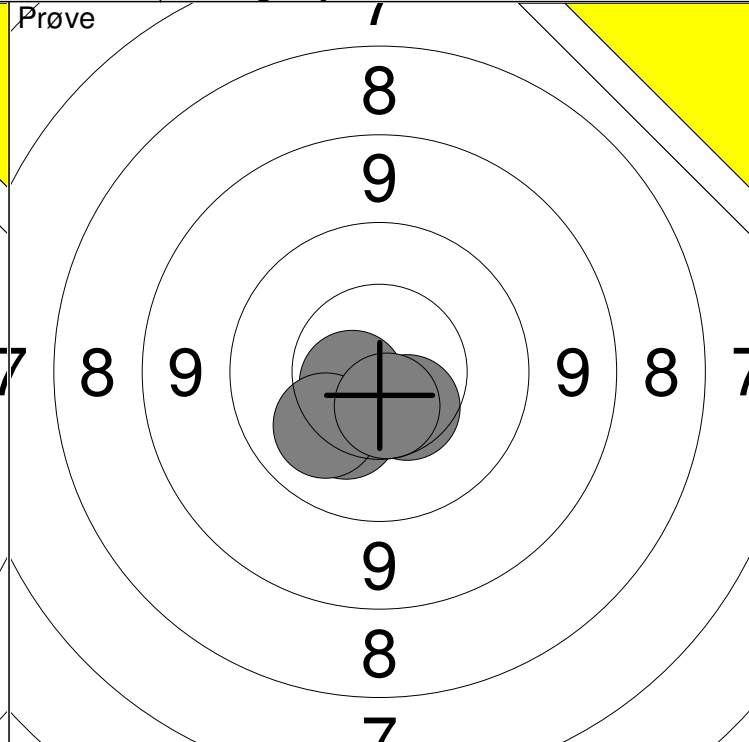
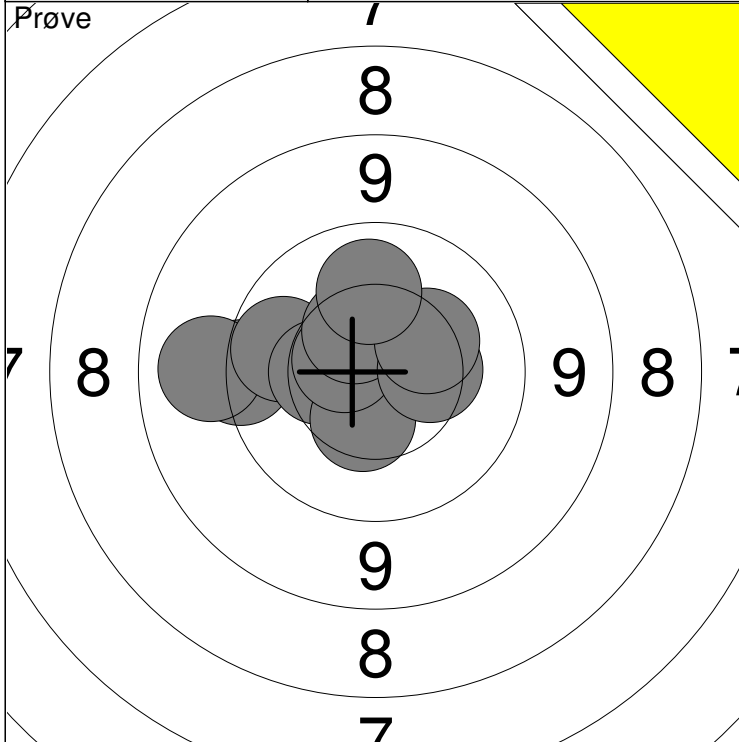

1: 9.5 ←	6: 10.6x ↖	Serie	98
2: 9.2 ←	7: 10.5 ↗		
3: 10.0 ←	8: 10.4 →	Total	0
4: 10.4 ←	9: 10.3 ↘		
5: 10.4 ↓	10: 10.1 ↑		

11: 10.3 ↙	Serie	50
12: 10.6x ↖		
13: 10.5 ↘	Total	0
14: 10.2 ↙		
15: 10.6x ↓		

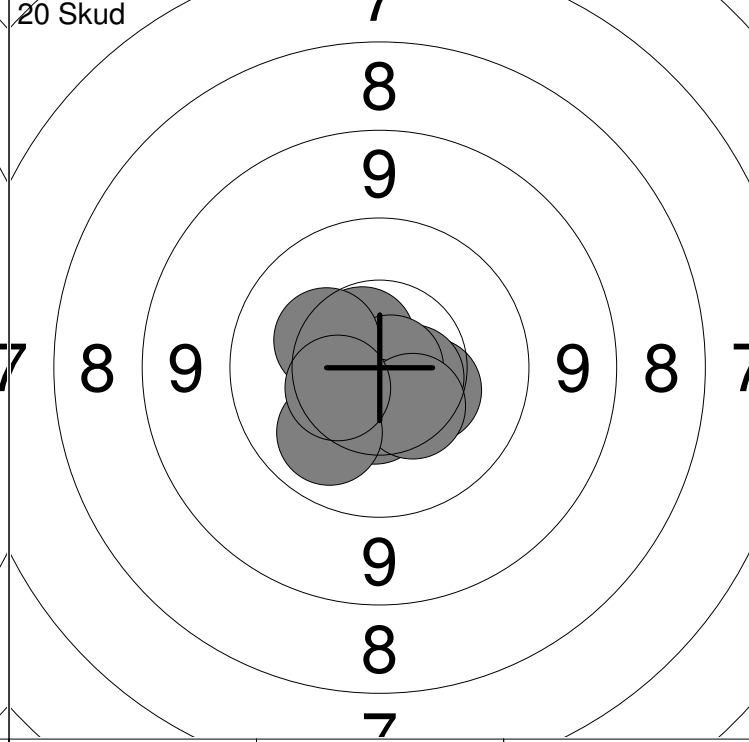
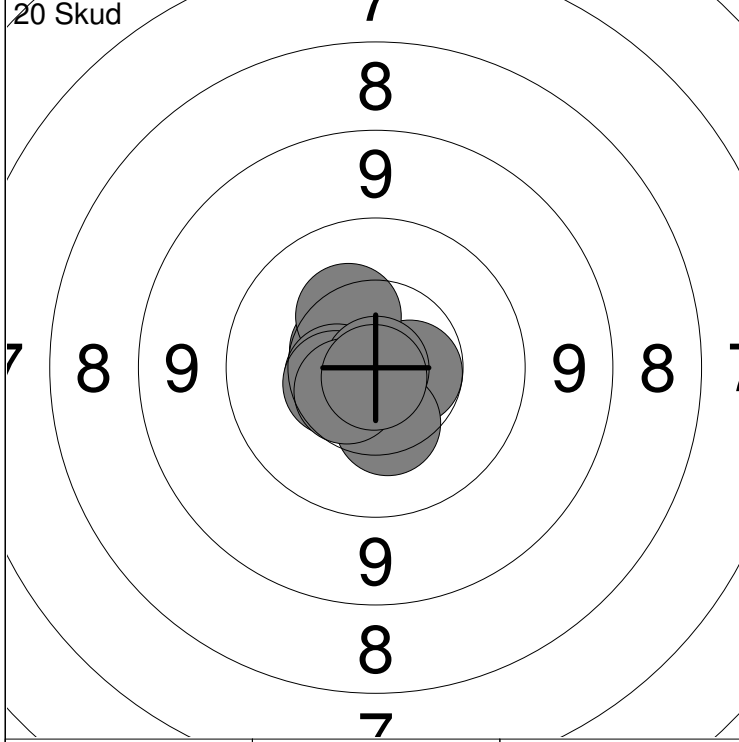

1: 10.8x ↖	6: 10.5 ←	Serie	100
2: 10.6x →	7: 10.4 ↓		
3: 10.6 ↗	8: 10.9x ↓	Total	100
4: 10.3 ↗	9: 10.6 ↖		
5: 10.5 ←	10: 10.8x ↓		

11: 10.5 ↖	Serie	100
12: 10.6x ↗		
13: 10.4 →	Total	200
14: 10.6x ↘		
15: 10.8x →	16: 10.5 ↓	
	17: 10.4 ↘	
	18: 10.1 ↘	
	19: 10.3 ↖	
	20: 10.5 ↖	

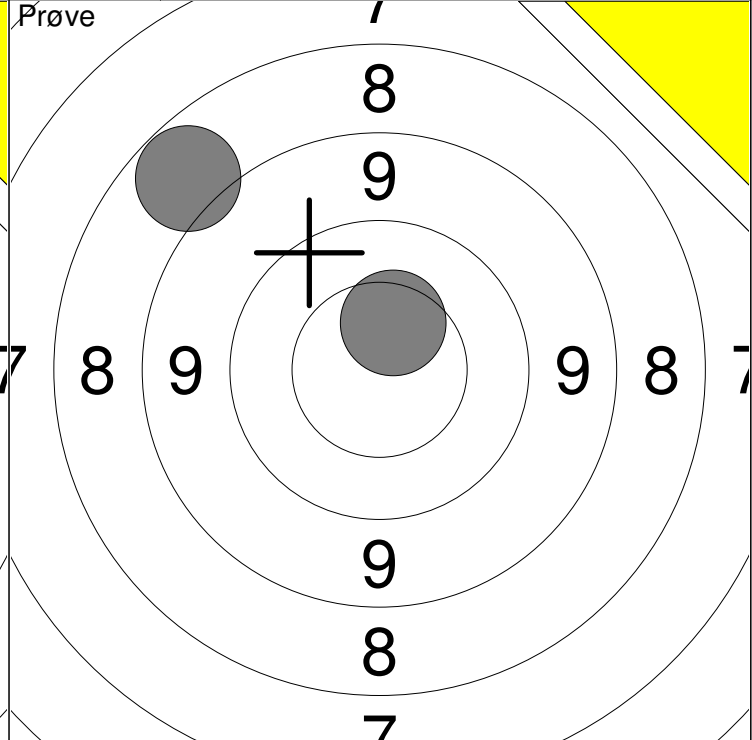
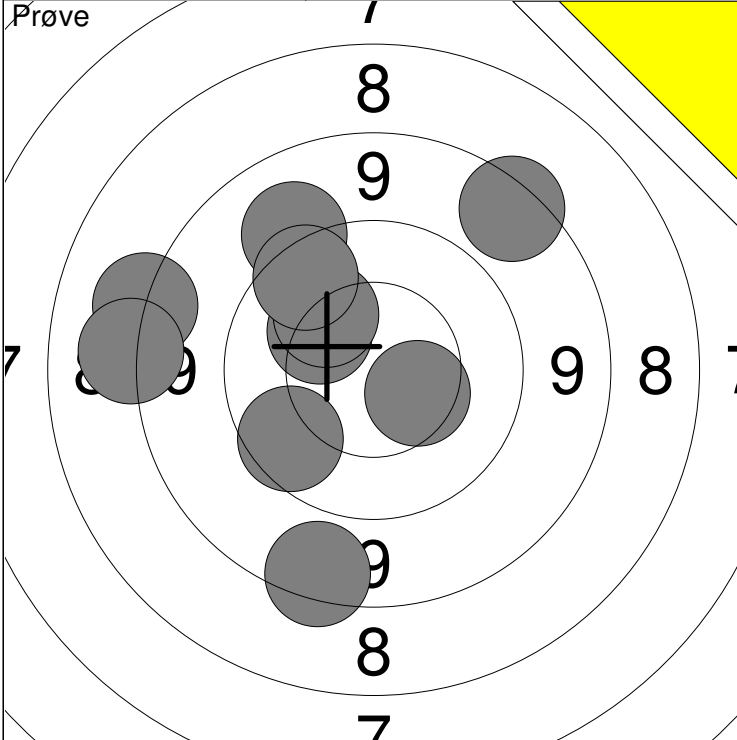

1: 8.6 ↓	6: 10.3 ↗	Serie	89
2: 8.4 ←	7: 9.3 ↗		
3: 9.8 ↙	8: 8.6 ↗	Total	0
4: 8.3 ←	9: 10.2 ↗		
5: 10.4 ↘	10: 9.7 ↗		

11: 8.0 ↖	Serie	18
12: 10.4 ↗		
Total		0

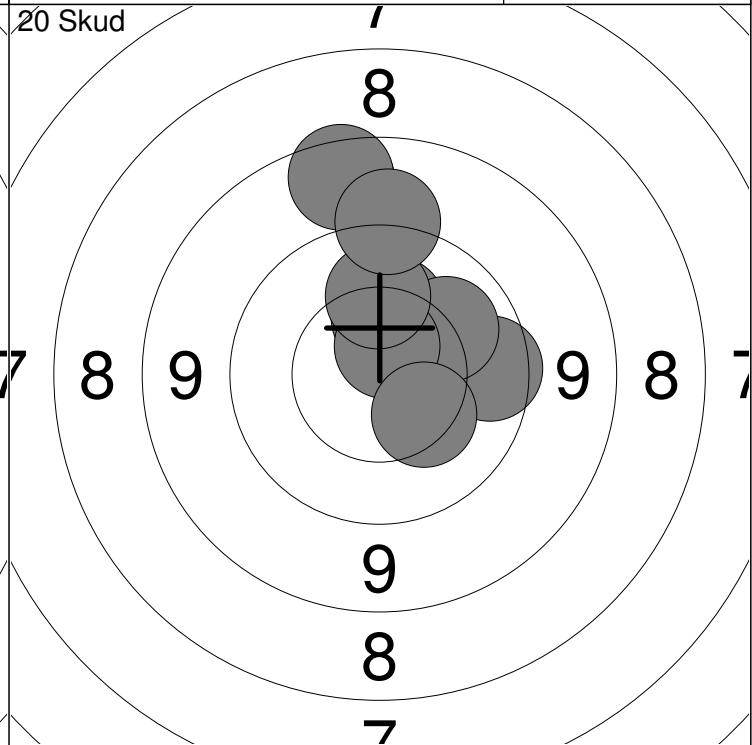
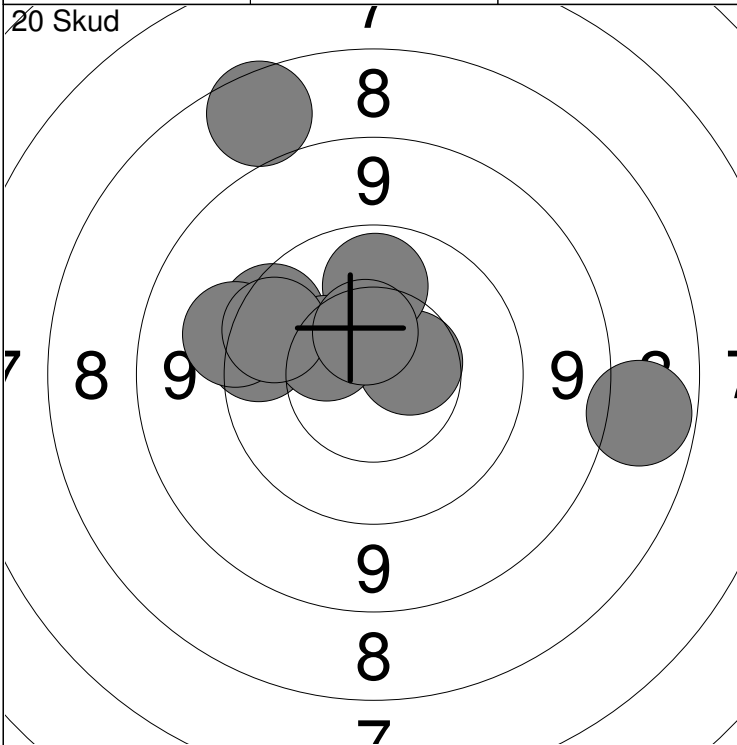

1: 9.7 ←	6: 10.4 ↗	Serie	91
2: 10.6 →	7: 9.4 ←		
3: 7.8 ↗	8: 9.8 ↙	Total	91
4: 10.0 ↑	9: 8.0 →		
5: 9.7 ←	10: 10.5 ↗		

11: 8.8 ↑	16: 10.1 ↗	Serie	96
12: 10.3 ↑	17: 10.6x ↑		
13: 10.3 ↑	18: 10.1 ↑	Total	187
14: 9.8 →	19: 9.3 ↑		
15: 10.4 ↑	20: 10.3 ↘		

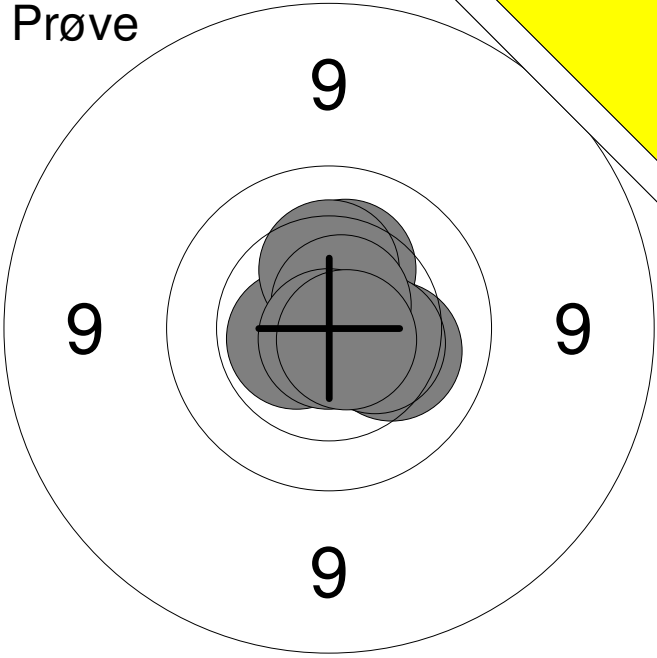
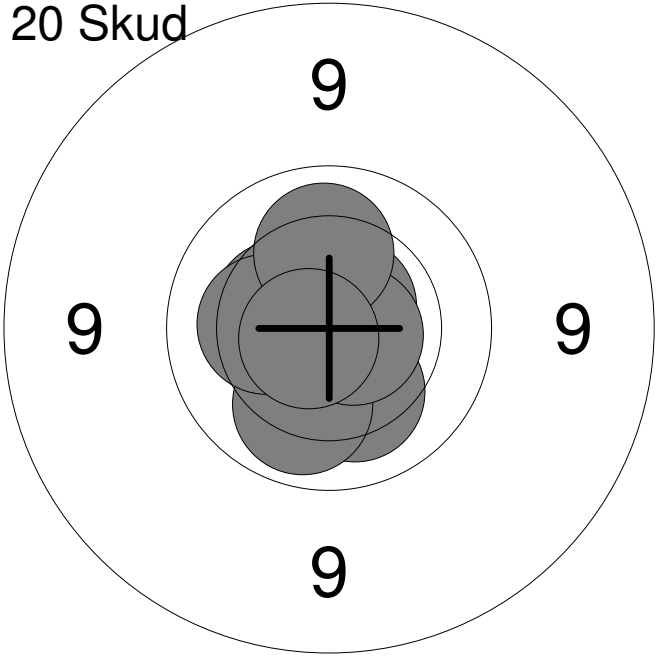
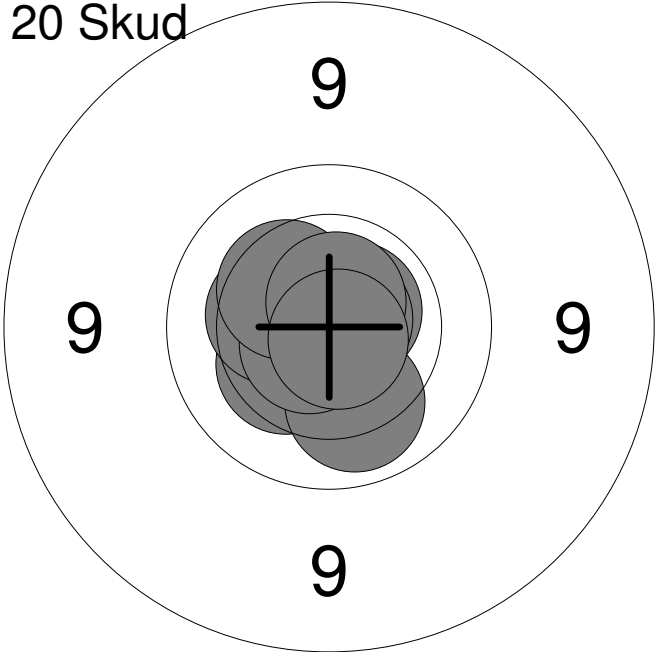
Hold	Skive	Kaj Mørk		
77	6	15m	Vester Hassing Skf. J1	
24.10.2013	15 meter riffelstævne 2013	Aalborg Skyttekreds		
Prøve 	1:	10.3	↑	
	2:	10.2	→	
	3:	10.4	→	
	4:	10.6x	←	
	5:	10.3	↑	
	6:	10.7x	↗	
	7:	10.8x	↓	
	8:	10.7x	↘	
	Serie			80.0
	Total			0.0
20 Skud 	1:	10.2	↓	
	2:	10.1	↓	
	3:	10.7x	←	
	4:	10.4	←	
	5:	10.8x	→	
	6:	10.7x	↗	
	7:	10.7x	→	
	8:	10.3	←	
	9:	10.1	↑	
	10:	10.7x	←	
Serie			100.0	
Total			100.0	
20 Skud 	11:	10.9x	↙	
	12:	10.3	↙	
	13:	10.4	←	
	14:	10.1	↓	
	15:	10.7x	↙	
	16:	10.3	↗	
	17:	10.7x	↗	
	18:	10.8x	↗	
	19:	10.7x	↑	
	20:	10.8x	↘	
Serie			100.0	
Total			200.0	

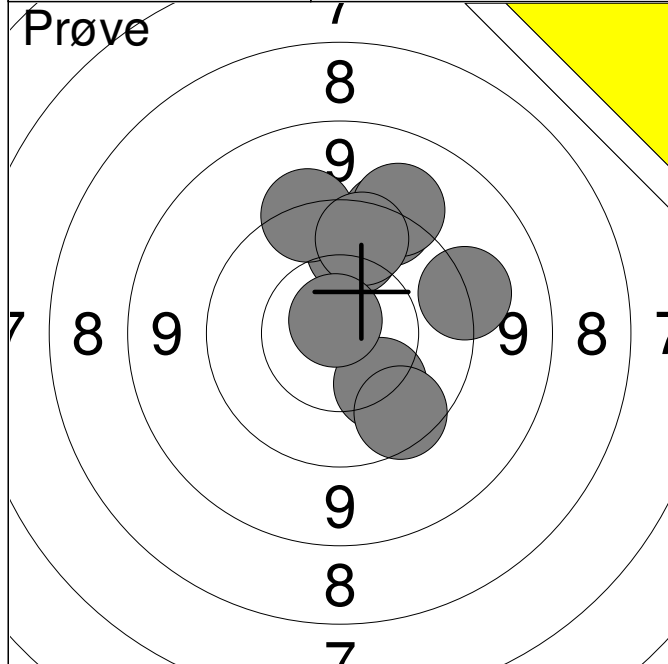

1:	9.4	→
2:	9.5	↑
3:	10.0	↑
4:	9.3	↑
5:	10.2	↓
6:	9.8	↓
7:	9.5	↑
8:	9.8	↑
9:	10.8x	↑

Serie	84.0
Total	0.0

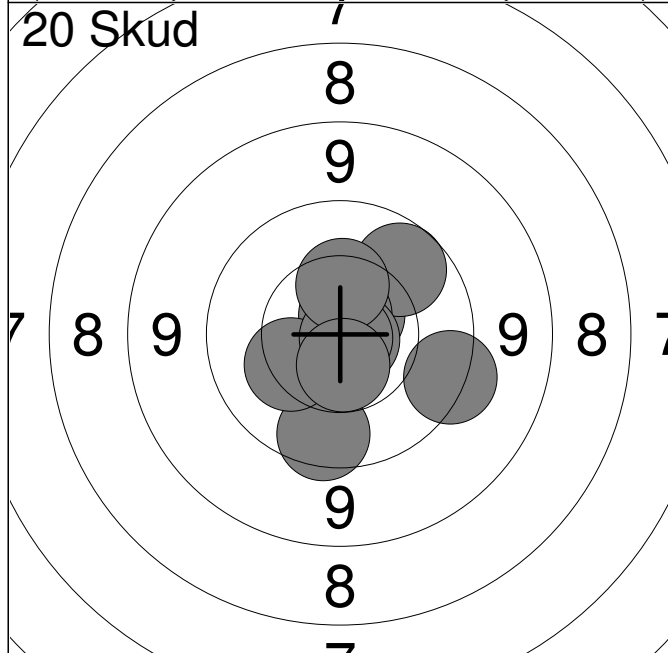

1:	10.6x	↗
2:	9.8	↓
3:	9.9	↗
4:	10.7x	↑
5:	10.3	↙
6:	10.8x	↘
7:	10.9x	↓
8:	9.5	→
9:	10.4	↑
10:	10.6x	↓

Serie	97.0
Total	97.0

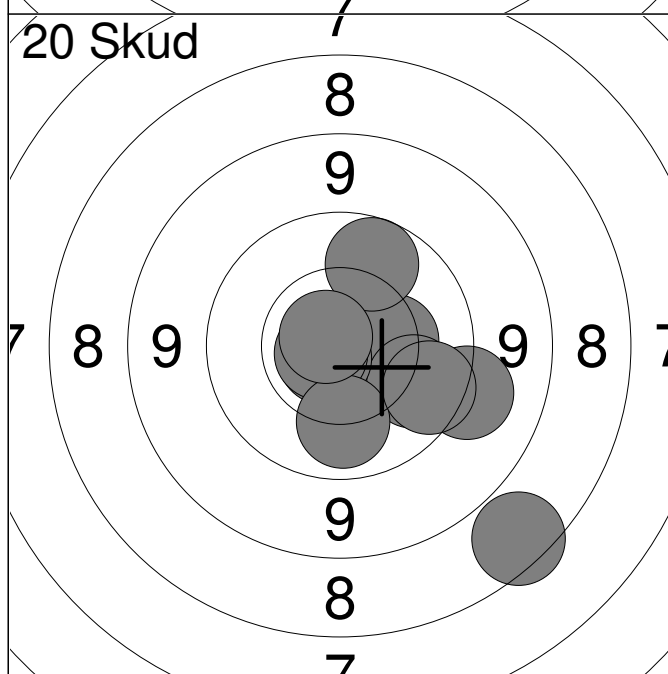

11:	10.3	→
12:	10.0	→
13:	10.7x	↙
14:	10.7x	↙
15:	10.1	↓
16:	9.9	↑
17:	9.3	→
18:	10.8x	↗
19:	9.8	↓
20:	7.7	↘

Serie	94.0
Total	191.0

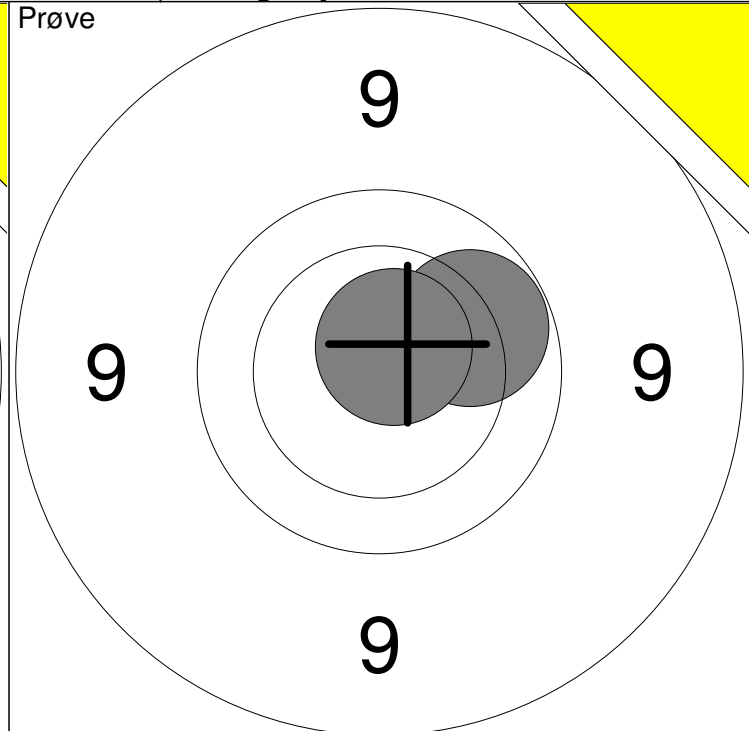
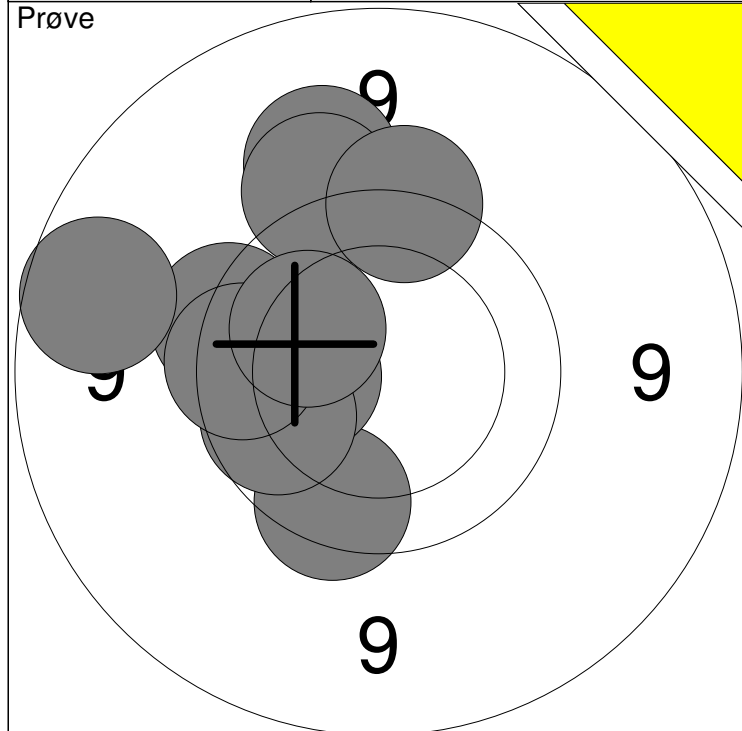

1: 9.3 ↗	6: 9.8 ↘	Serie	91
2: 9.5 ↗	7: 10.2 ←		
3: 9.6 ↗	8: 9.9 ←	Total	0
4: 9.7 ↖	9: 9.8 ←		
5: 8.9 ←	10: 10.1 ↖		

11: 10.0 ↗	Serie	20
12: 10.7x ↗		
Total		0

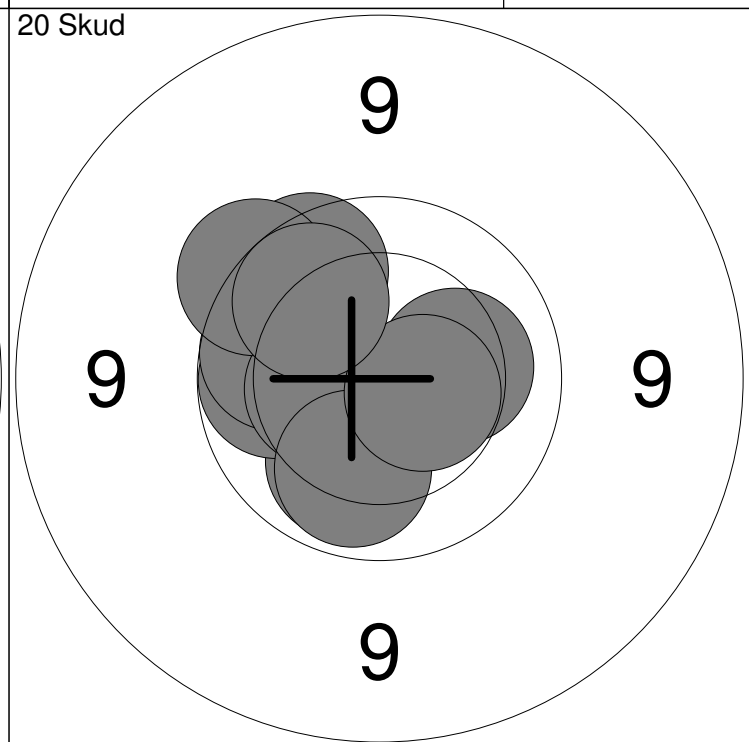
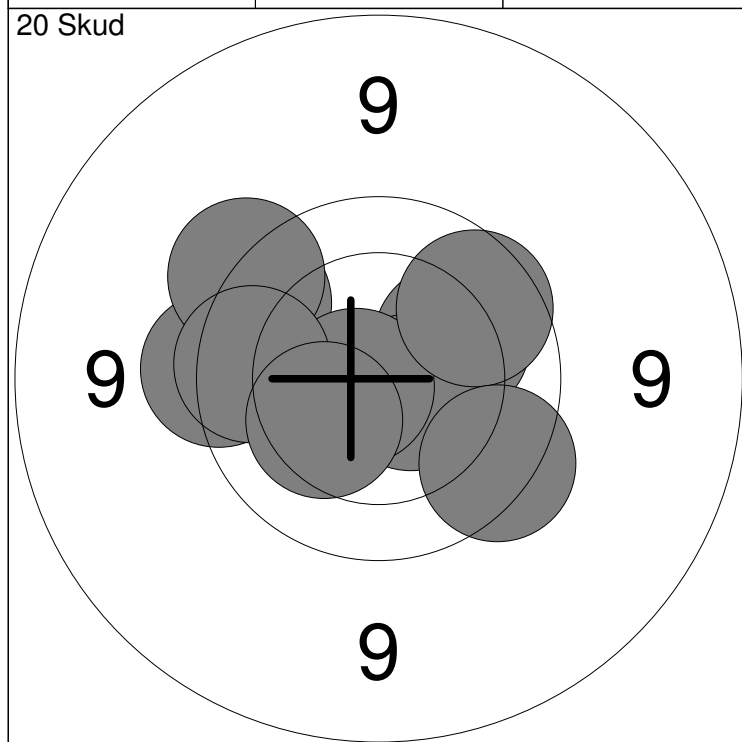

1: 10.2 ↗	6: 9.9 ↗	Serie	94
2: 9.7 ↖	7: 9.6 ↗		
3: 9.6 ←	8: 9.7 ↘	Total	94
4: 10.6x ↗	9: 9.8 ←		
5: 10.7x ↖	10: 10.3 ↘		

11: 10.1 ↘	16: 10.0 ↘	Serie	97
12: 10.0 ←	17: 9.8 ↗		
13: 10.2 →	18: 9.6 ↗	Total	191
14: 9.9 ←	19: 10.5x ↗		
15: 10.4 ←	20: 10.0 ↗		

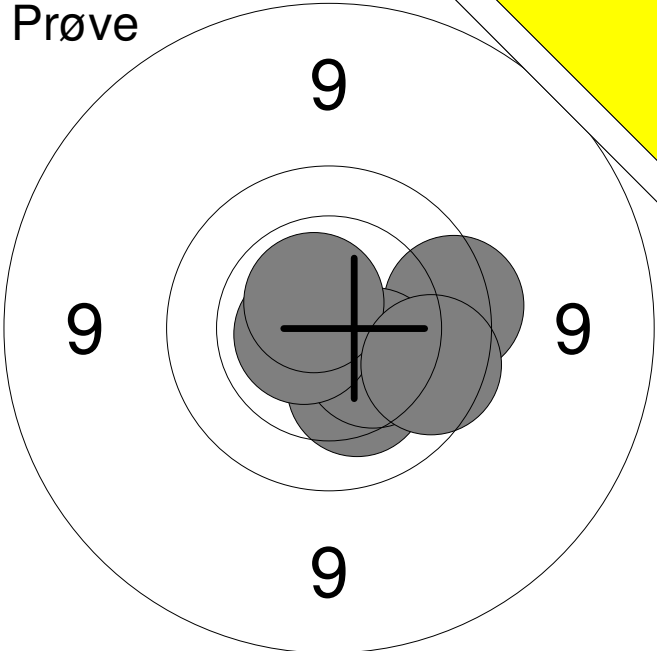
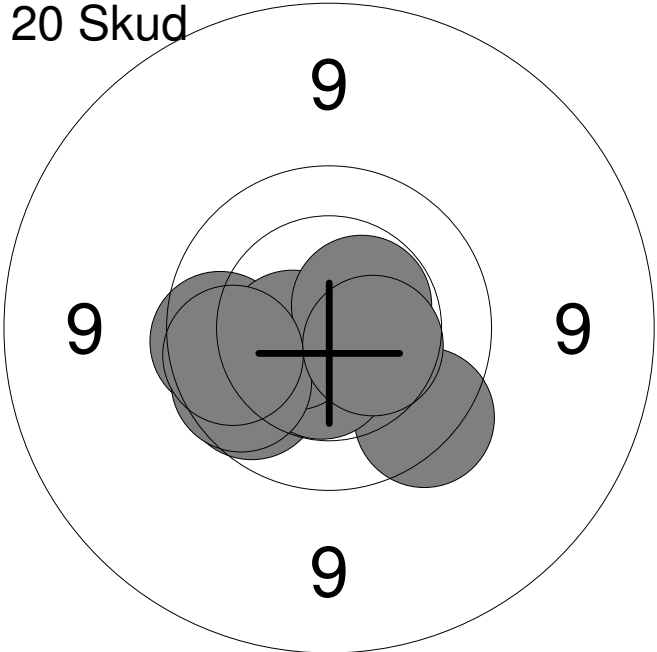
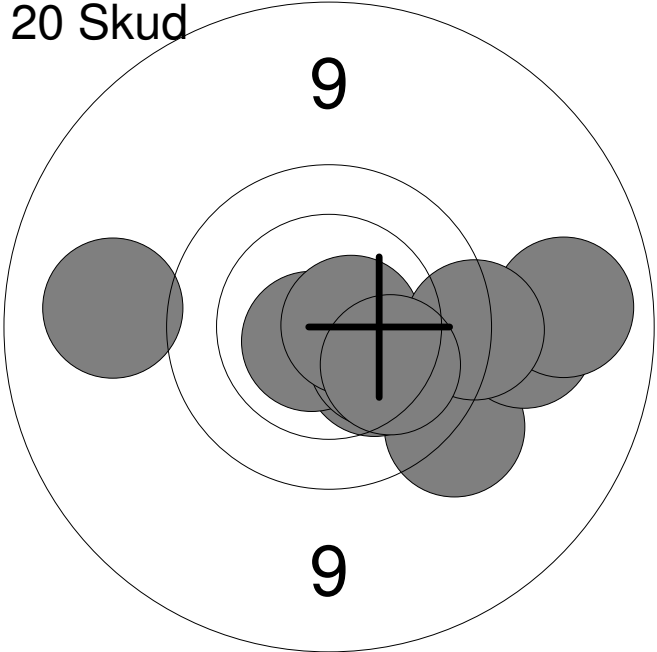
Hold	Skive	Oliver Brun Flodin	
77	9	15m	Mou & Omegns Skf. J2
24.10.2013	15 meter riffelstævne 2013	Aalborg Skyttekreds	
Prøve		1: 9.7 →	
		2: 10.2 ↓	
		3: 10.4 ↓	
		4: 10.7x ←	
		5: 10.6x ↗	
		6: 9.9 ↓	
		Serie	58.0
		Total	0.0
20 Skud		1: 9.9 ←	
		2: 10.6x ↓	
		3: 9.7 ↓	
		4: 9.8 ←	
		5: 10.5x ↓	
		6: 10.5x ←	
		7: 10.5x ↗	
		8: 9.9 ←	
		9: 10.4 →	
		10: 9.9 ←	
		Serie	95.0
		Total	95.0
20 Skud		11: 9.2 ←	
		12: 9.5 ↓	
		13: 9.3 →	
		14: 9.1 →	
		15: 10.3 ↓	
		16: 10.7x ↓	
		17: 10.3 ↓	
		18: 10.7x →	
		19: 9.6 →	
		20: 10.2 ↓	
		Serie	95.0
		Total	190.0

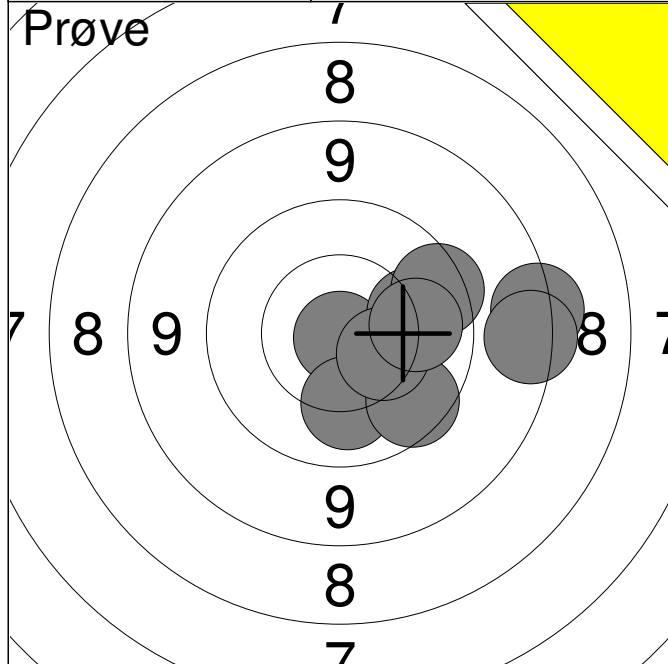

1:	10.9x	↓
2:	10.2	↘
3:	10.1	↓
4:	10.1	→
5:	8.5	→
6:	9.7	→
7:	8.6	→
8:	9.8	↓
9:	10.4	↘
10:	10.1	→
Serie		94.0
Total		0.0

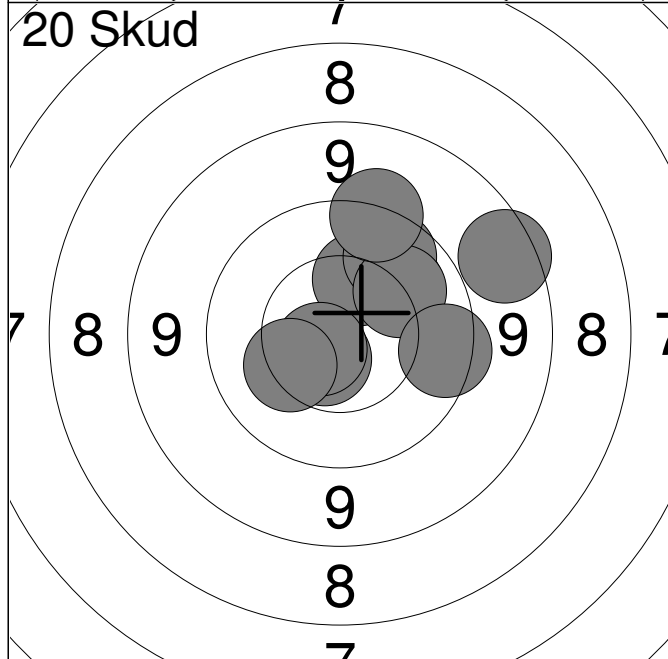

1:	10.6x	↙
2:	10.1	↗
3:	10.3	↑
4:	9.9	↗
5:	8.7	→
6:	10.7x	↙
7:	10.1	↗
8:	9.7	→
9:	9.5	↑
10:	10.3	↙
Serie		95.0
Total		95.0

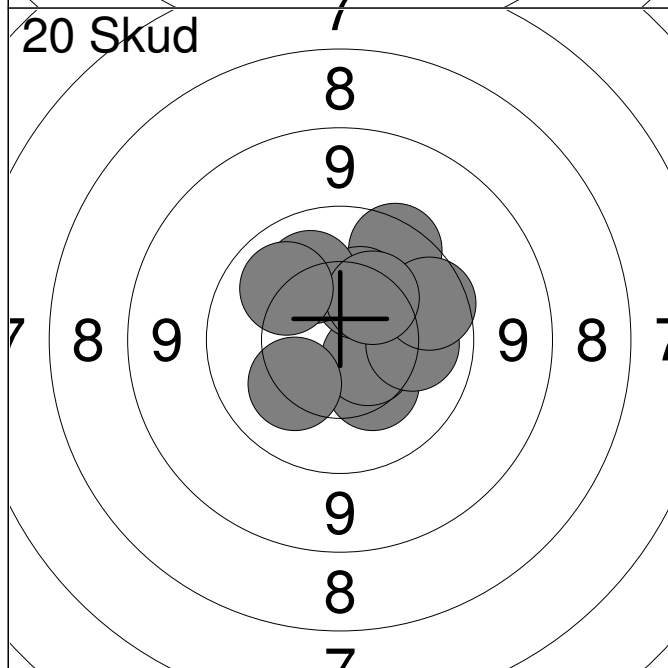

11:	10.3	↘
12:	10.6	↘
13:	10.1	→
14:	10.2	↙
15:	9.7	↗
16:	10.4	↗
17:	9.8	→
18:	10.2	↗
19:	10.3	↗
20:	10.1	↖
Serie		98.0
Total		193.0

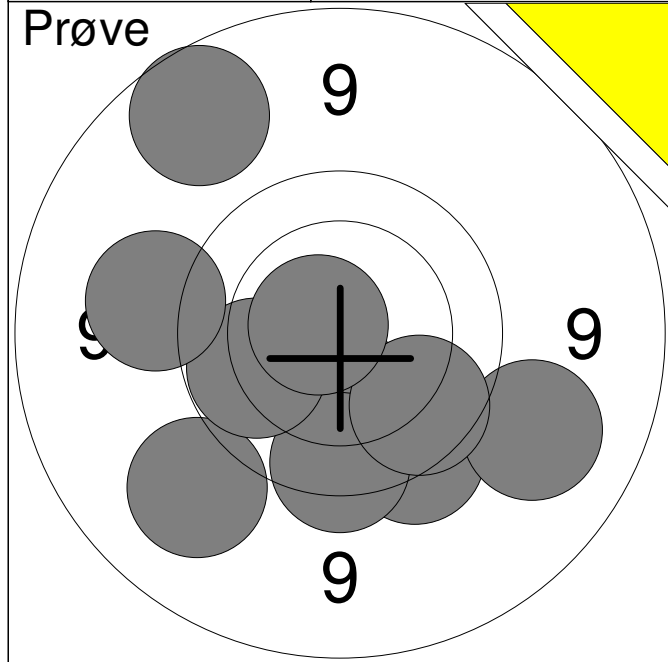

1:	9.6	↘
2:	9.2	↙
3:	10.2	↘
4:	9.7	↘
5:	9.2	↘
6:	10.0	↙
7:	9.9	↘
8:	9.4	↗
9:	10.7x	↗
10:	8.9	↗
Serie	92.0	
Total	0.0	

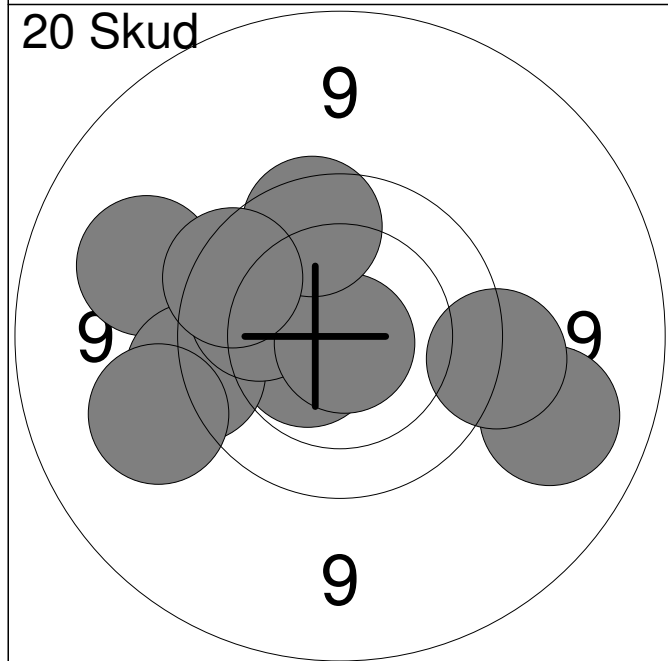

1:	9.3	↖
2:	10.5x	↙
3:	9.6	↖
4:	9.3	↖
5:	10.0	↗
6:	9.1	↘
7:	10.9x	↘
8:	9.8	↗
9:	9.5	↘
10:	9.8	↗
Serie	93.0	
Total	93.0	

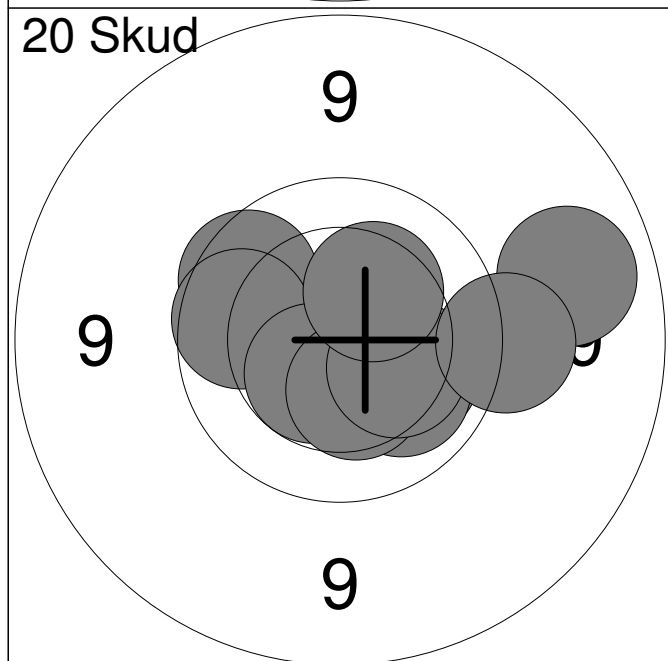

11:	9.1	→
12:	9.8	↗
13:	10.1	↘
14:	10.1	↘
15:	9.9	↗
16:	10.5x	↙
17:	10.4	↘
18:	10.3	↘
19:	9.5	→
20:	10.3	↗
Serie	96.0	
Total	189.0	

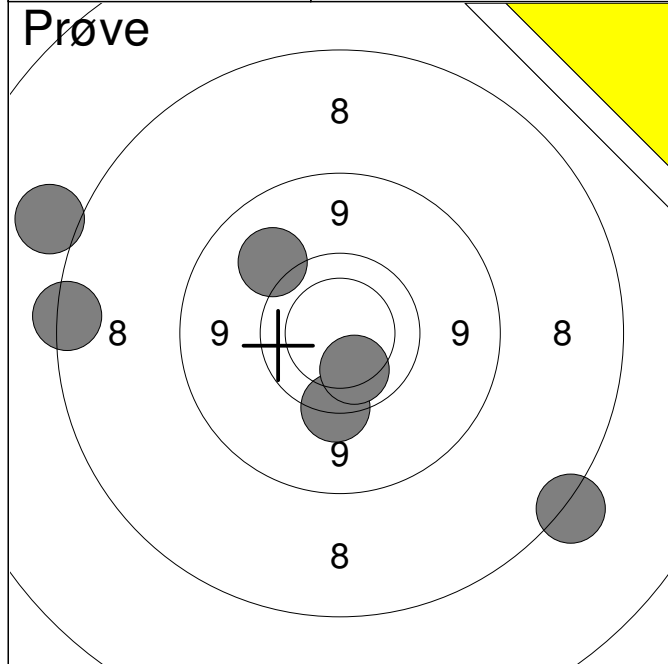

1:	7.6	↘
2:	7.4	↗
3:	9.6	↘
4:	9.3	↗
5:	7.8	↖
6:	10.1	↘

Serie	49.0
Total	0.0

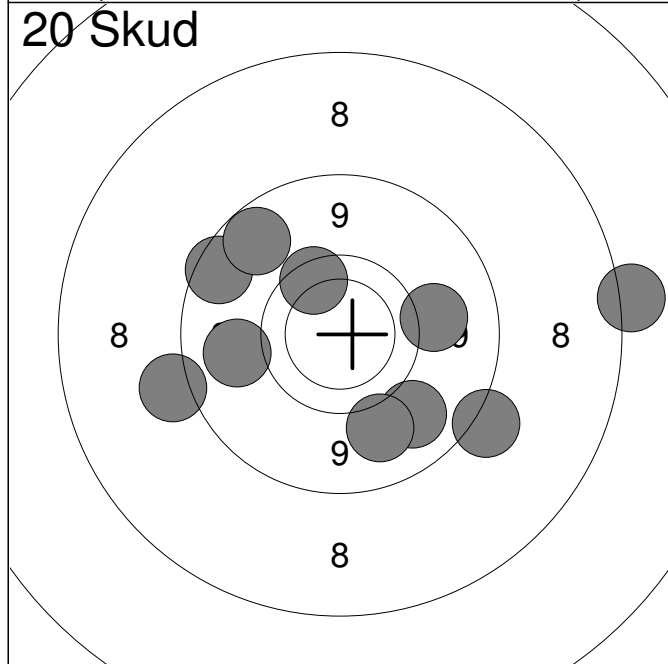

1:	8.6	↘
2:	8.5	↖
3:	8.9	↗
4:	9.2	↖
5:	7.6	→
6:	9.0	↗
7:	9.8	↗
8:	9.2	↘
9:	9.3	→
10:	9.2	↘

Serie	85.0
Total	85.0

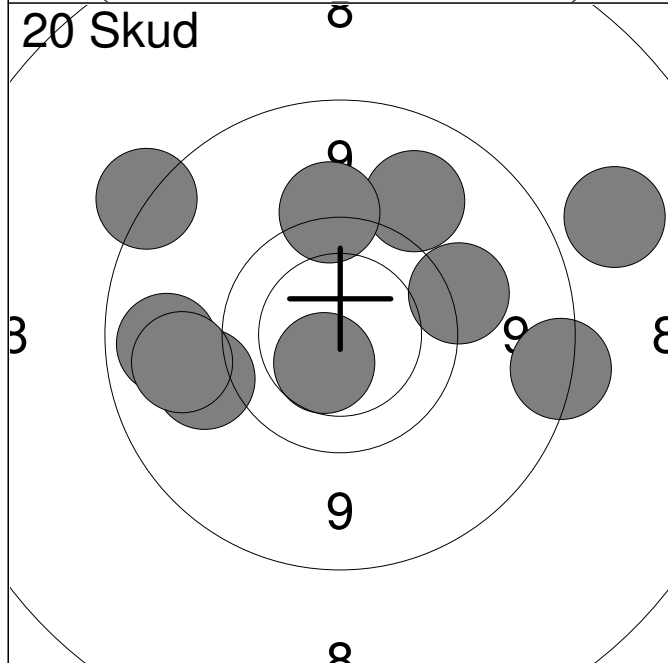

11:	9.0	←
12:	10.5	↘
13:	9.2	↗
14:	8.3	→
15:	9.5	↑
16:	9.3	↖
17:	8.7	→
18:	9.4	→
19:	9.2	↖
20:	8.7	↗

Serie	88.0
Total	173.0

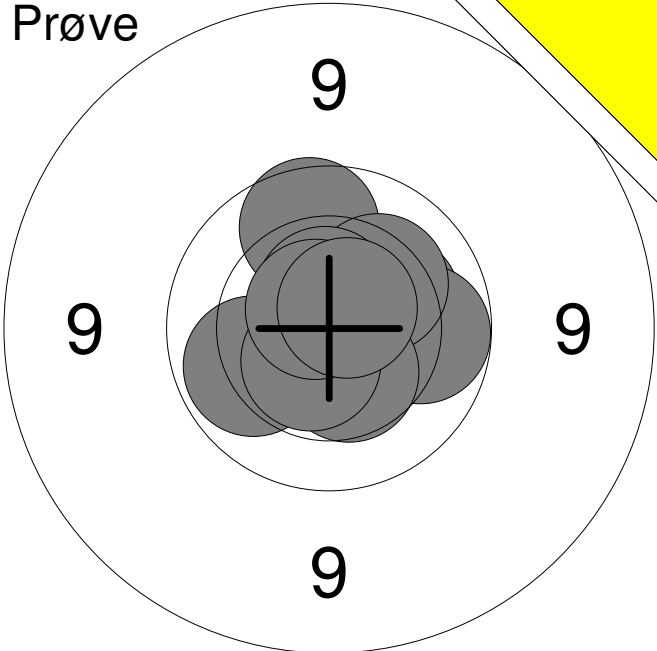
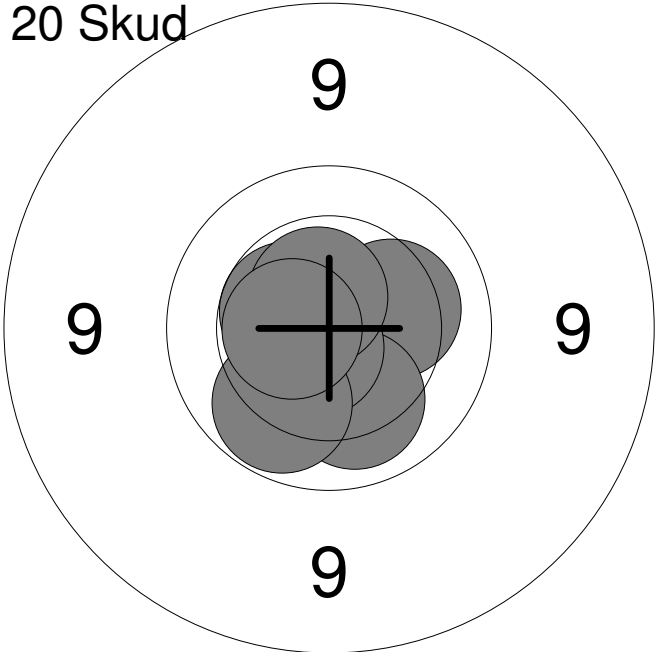
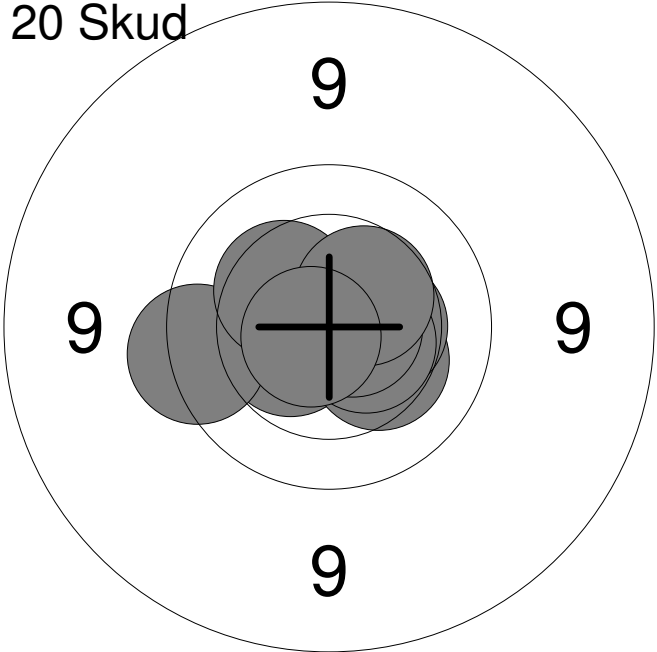
Hold	Skive	Knud Møller	
78	1		
15m	Samsø Skytteforening	MV1	
24.10.2013	15 meter riffelstævne 2013	Aalborg Skyttekreds	
Prøve 	1:	9.9	↑
	2:	10.2	→
	3:	10.0	→
	4:	10.2	↗
	5:	10.0	↖
	6:	10.6x	↑
	7:	10.4	↓
	8:	10.5x	↘
	9:	10.7x	↗
	10:	10.7x	↗
	Serie		99.0
Total		0.0	
20 Skud 	1:	10.7x	↑
	2:	10.5x	→
	3:	10.3	↓
	4:	10.2	→
	5:	10.5	↖
	6:	10.1	↓
	7:	10.7x	↘
	8:	10.0	↘
	9:	10.6x	↑
	10:	10.5x	←
	Serie		100.0
Total		100.0	
20 Skud 	11:	10.6x	←
	12:	10.5	↖
	13:	9.7	←
	14:	10.3	↗
	15:	10.3	↘
	16:	10.4	→
	17:	10.5x	↘
	18:	10.7x	→
	19:	10.4	↗
	20:	10.7x	←
	Serie		99.0
Total		199.0	

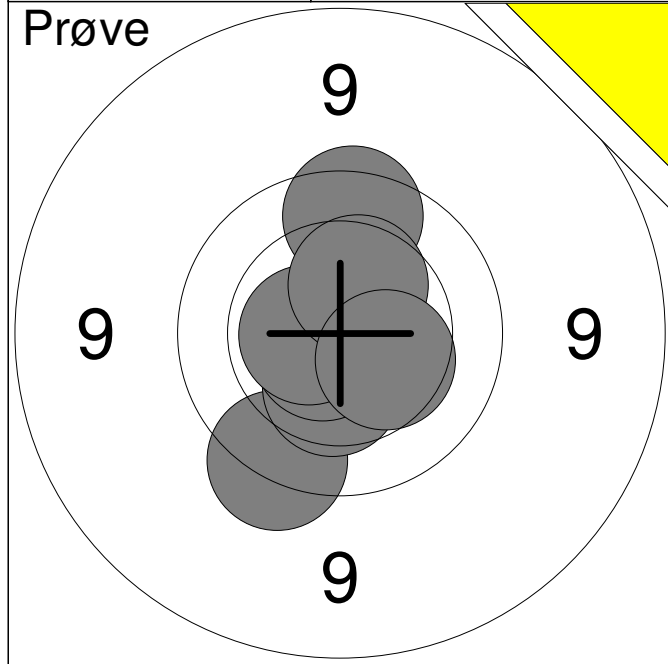

1:	9.6	↙
2:	10.4	↓
3:	10.7x	←
4:	10.7x	↙
5:	10.6x	←
6:	9.8	↑
7:	10.4	↑
8:	10.4	↘
Serie		78.0
Total		0.0

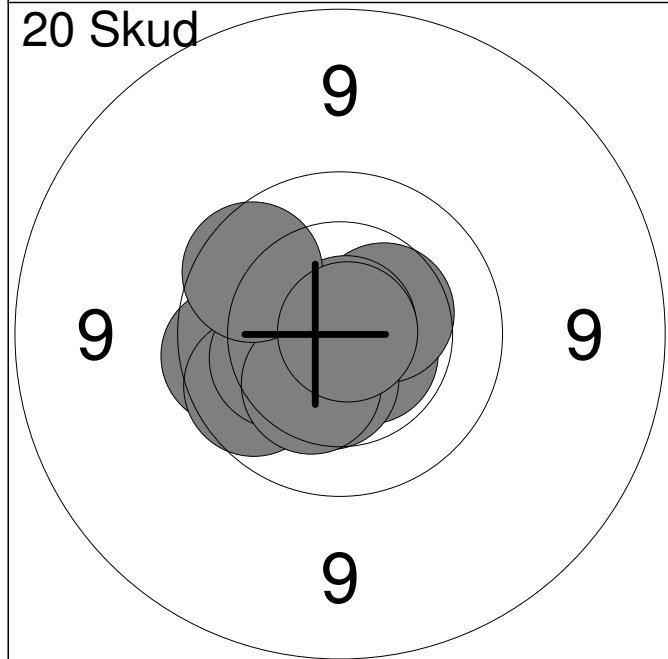

1:	10.6x	↘
2:	10.4	→
3:	10.8x	↗
4:	9.8	←
5:	9.9	↙
6:	10.2	←
7:	10.4	↓
8:	10.3	↙
9:	9.9	↗
10:	10.9x	→
Serie		97.0
Total		97.0

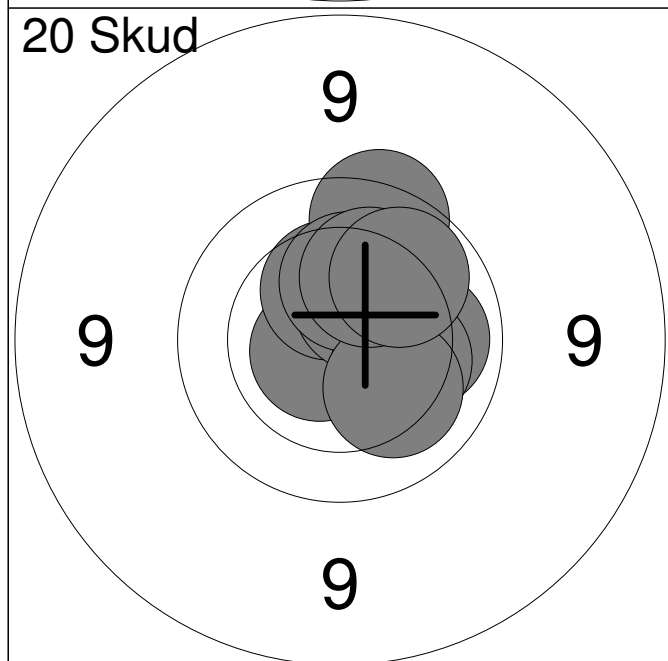

11:	10.7x	←
12:	10.4	↑
13:	10.5	↗
14:	9.7	↑
15:	10.1	→
16:	10.2	↘
17:	10.3	↑
18:	10.2	↘
19:	10.2	↗
20:	10.0	↗
Serie		99.0
Total		196.0

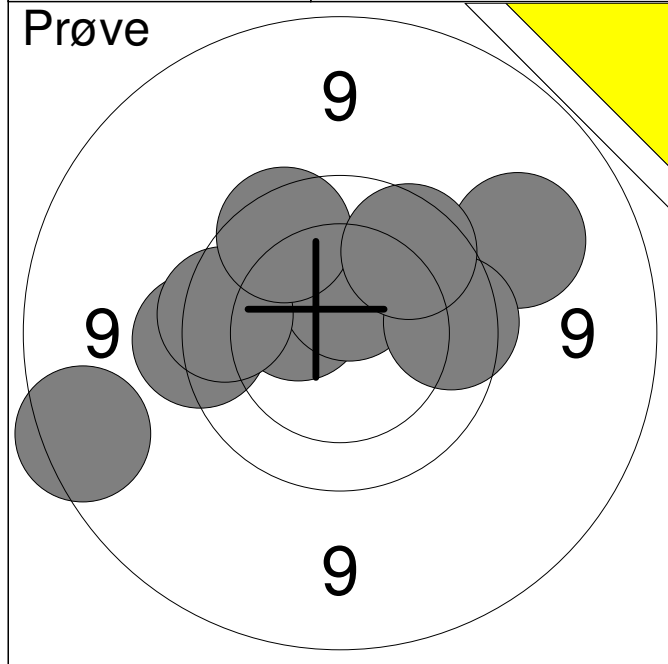

1:	8.8	←
2:	10.4	↖
3:	9.6	←
4:	10.5x	↑
5:	9.3	↗
6:	9.8	←
7:	9.8	→
8:	9.8	↗
9:	9.8	↗

Serie	82.0
Total	0.0

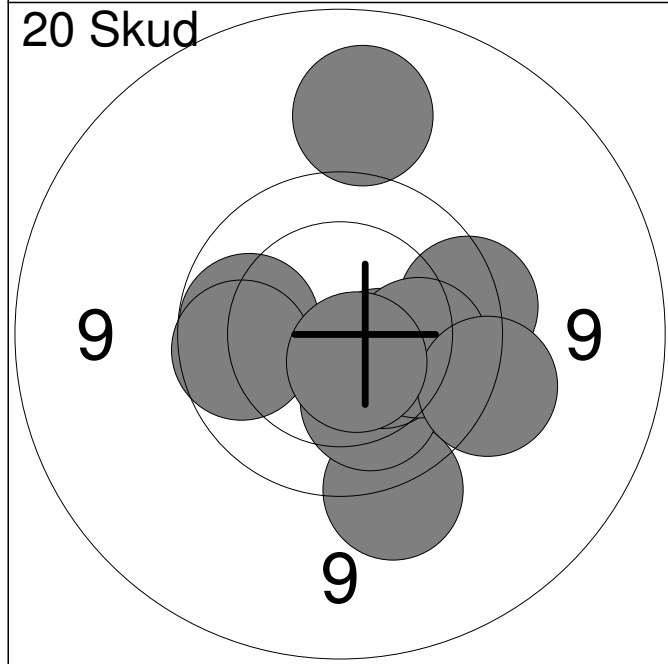

1:	9.2	↑
2:	9.5	↓
3:	10.2	↓
4:	9.7	→
5:	10.0	←
6:	10.4	↘
7:	9.9	←
8:	10.1	→
9:	9.6	→
10:	10.6x	↓

Serie	95.0
Total	95.0

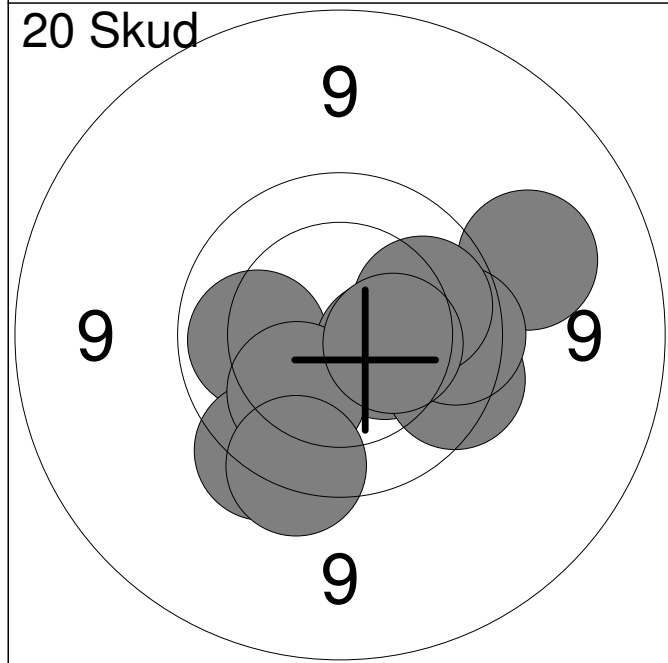

11:	10.1	←
12:	9.7	↘
13:	10.4	→
14:	9.8	→
15:	9.3	→
16:	9.8	→
17:	10.2	↘
18:	10.0	→
19:	9.7	↓
20:	10.4	→

Serie	95.0
Total	190.0

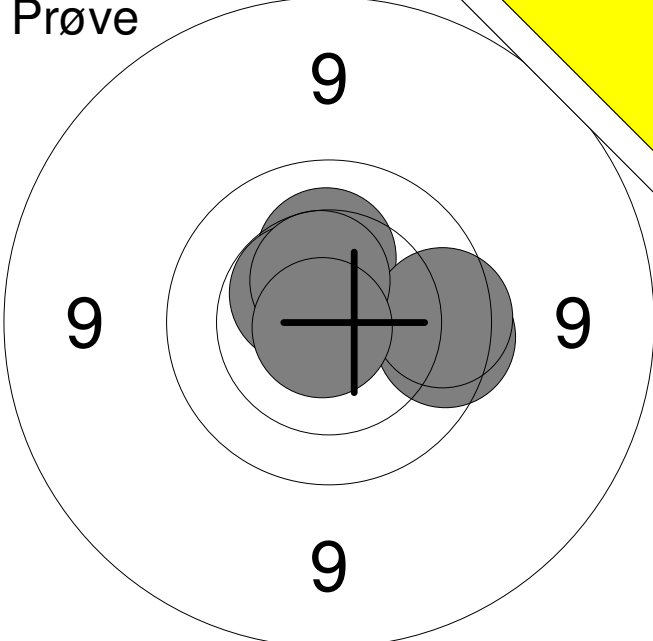
Prøve 	1: 9.8 →
	2: 10.3 ↑
	3: 9.8 →
	4: 10.5x ↗
	5: 10.5x ↑
	6: 10.9x ↘
	Serie 58.0
Total 0.0	

20 Skud 	1: 10.5x ↖
	2: 10.0 ↗
	3: 10.3 →
	4: 10.8x ↓
	5: 10.9x →
	6: 10.6x ↓
	7: 10.7x ↙
	8: 10.6x →
	9: 9.9 ↗
	10: 9.8 ↖
	Serie 98.0
Total 98.0	

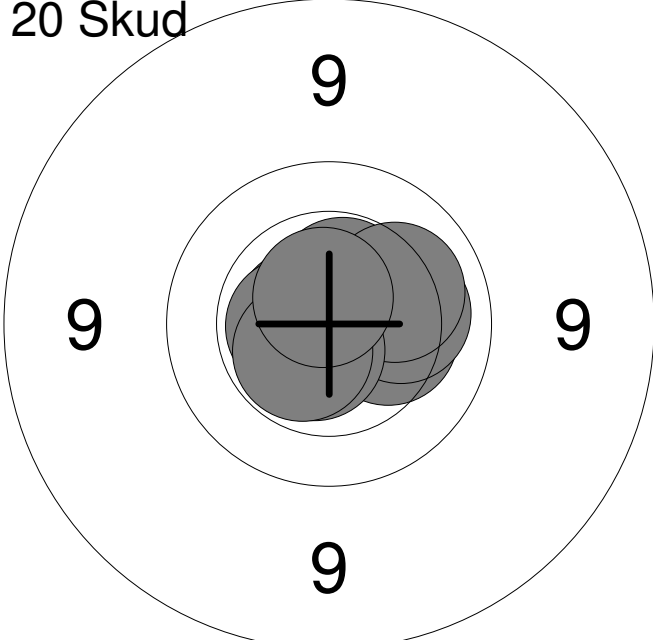
20 Skud 	11: 10.3 →
	12: 10.7x ↖
	13: 10.3 →
	14: 10.6x ←
	15: 10.5x ↑
	16: 10.2 →
	17: 10.2 →
	18: 10.6x ↘
	19: 10.5x ↙
	20: 10.7x ↑
	Serie 100.0
Total 198.0	

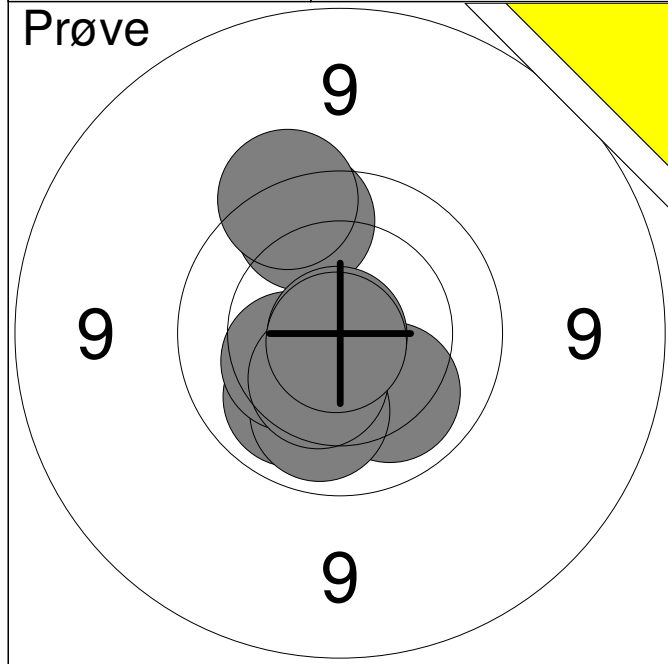

1:	9.8	↑
2:	9.6	↑
3:	10.1	↓
4:	10.1	↓
5:	10.1	↓
6:	10.3	↙
7:	10.4	↓
8:	10.9x	↙
9:	10.8x	↓
Serie		88.0
Total		0.0

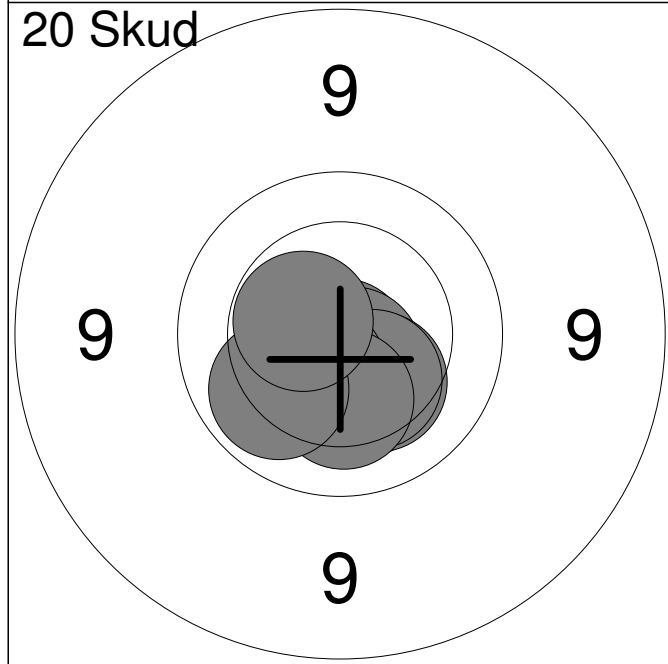

1:	10.8x	↓
2:	10.3	↓
3:	10.7x	↓
4:	10.3	↓
5:	10.4	↓
6:	10.2	↙
7:	10.5	↙
8:	10.2	↓
9:	10.1	↙
10:	10.5x	↙
Serie		100.0
Total		100.0

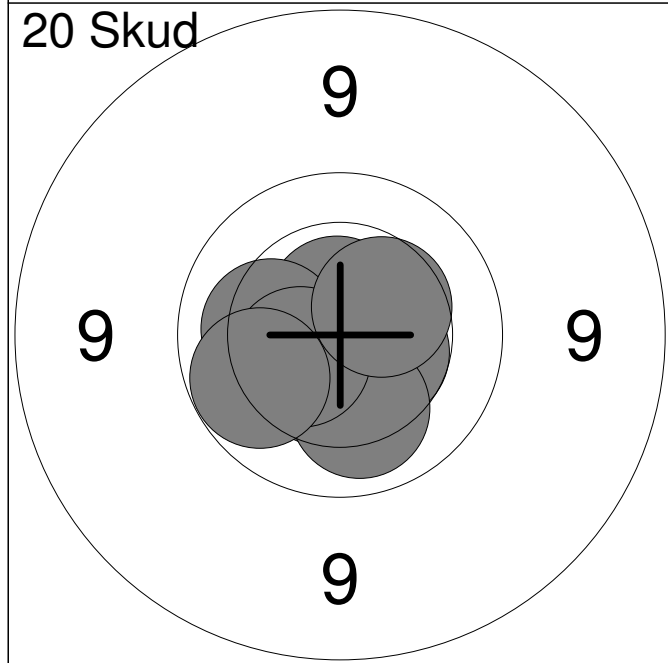

11:	10.6x	↑
12:	10.8x	↓
13:	10.3	↙
14:	10.2	↙
15:	10.5	↓
16:	10.5	↘
17:	10.1	↓
18:	10.5	↙
19:	10.0	↙
20:	10.4	↗
Serie		100.0
Total		200.0

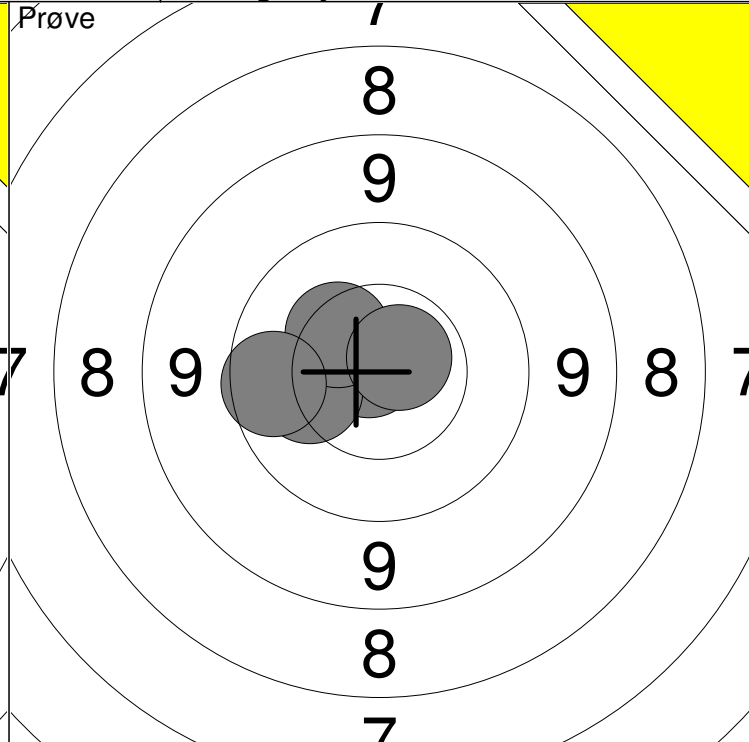
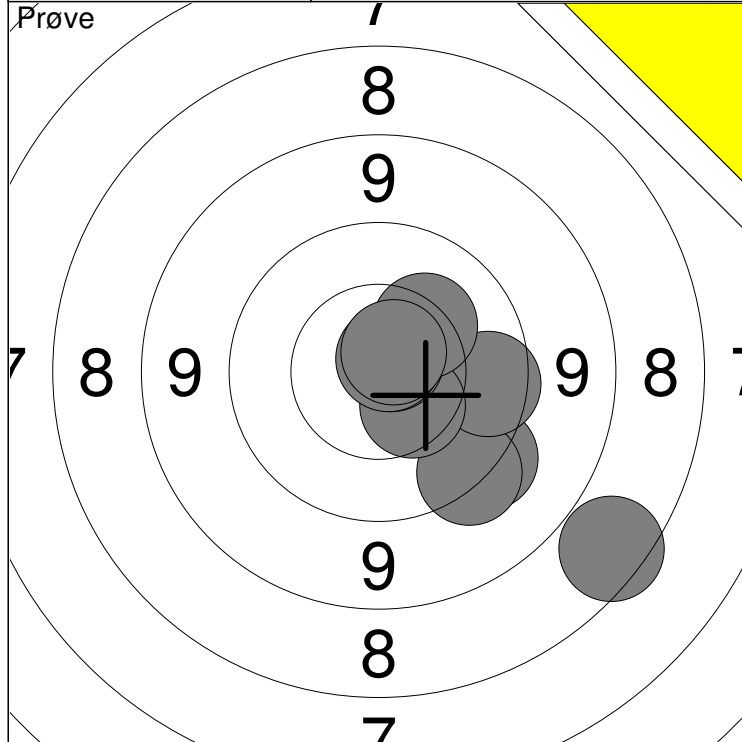

1: 7.7 ↘	6: 10.5 ↘	Serie	94
2: 9.5 ↘	7: 10.8x ↗		
3: 9.5 ↘	8: 10.8x ↗	Total	0
4: 10.7x →	9: 10.3 ↗		
5: 9.8 →	10: 10.7x ↗		

11: 10.8x ↖	Serie	49
12: 10.2 ←		
13: 10.4 ↖	Total	0
14: 9.8 ←		
15: 10.7x ↗		

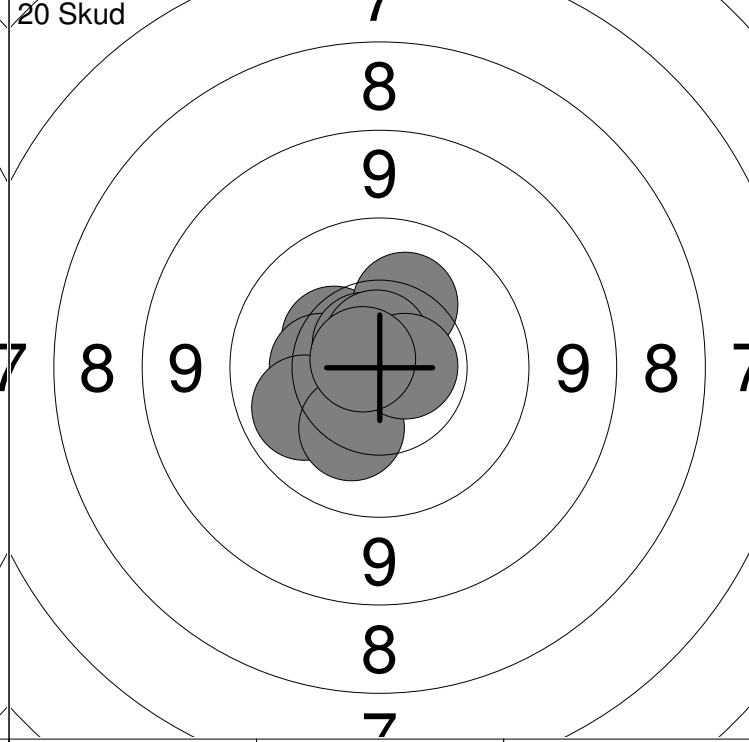
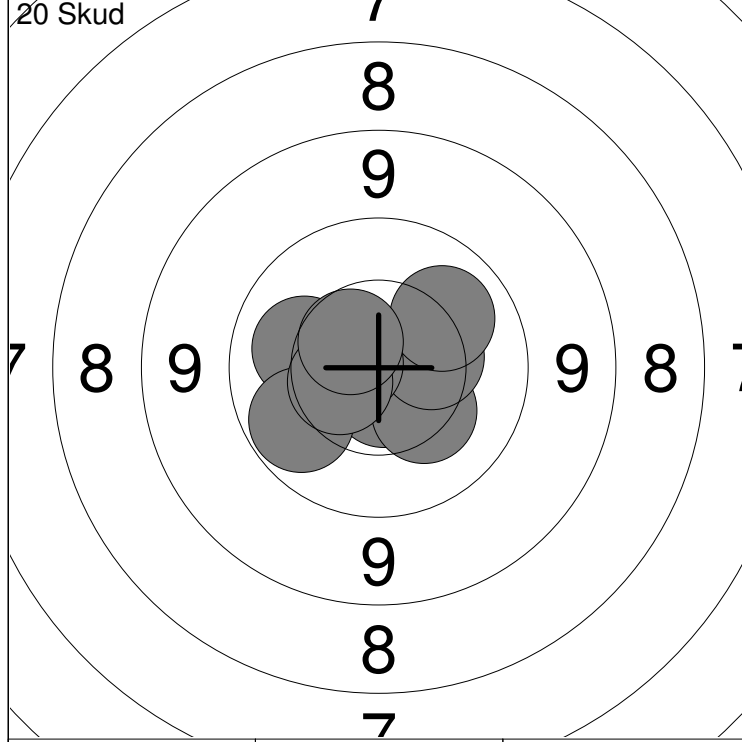

1: 10.7x ↘	6: 10.2 ←	Serie	100
2: 10.3 ←	7: 10.7x ←		
3: 10.3 ↘	8: 10.0 ←	Total	100
4: 10.4 →	9: 10.5 ←		
5: 10.1 ↗	10: 10.6 ↖		

11: 10.4 ↖	Serie	100
12: 10.3 ↗		
13: 10.4 ←	Total	200
14: 10.1 ←		
15: 10.3 ↘	16: 10.7x ↗	
	17: 10.8x ↗	
	18: 10.7x ↗	
	19: 10.7x →	
	20: 10.8x ↖	

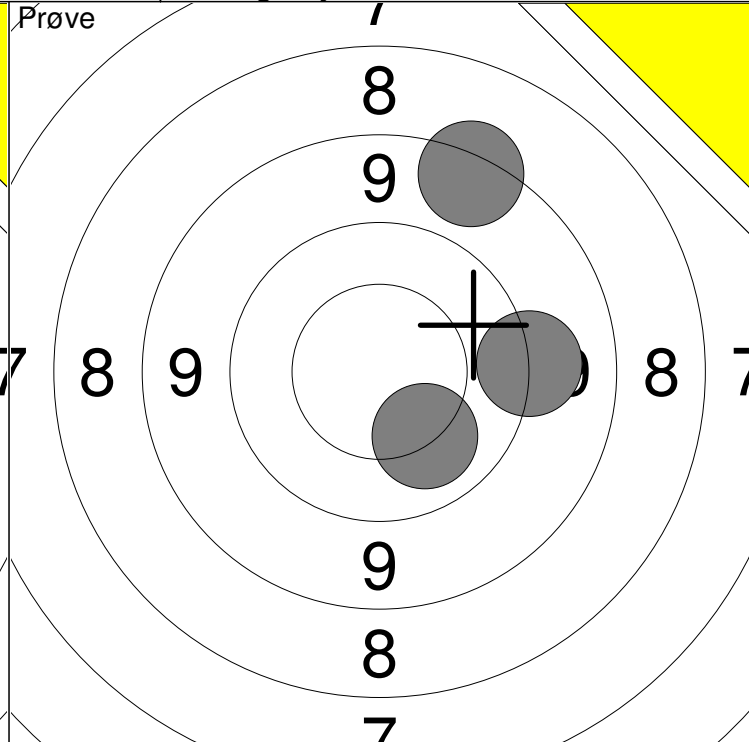
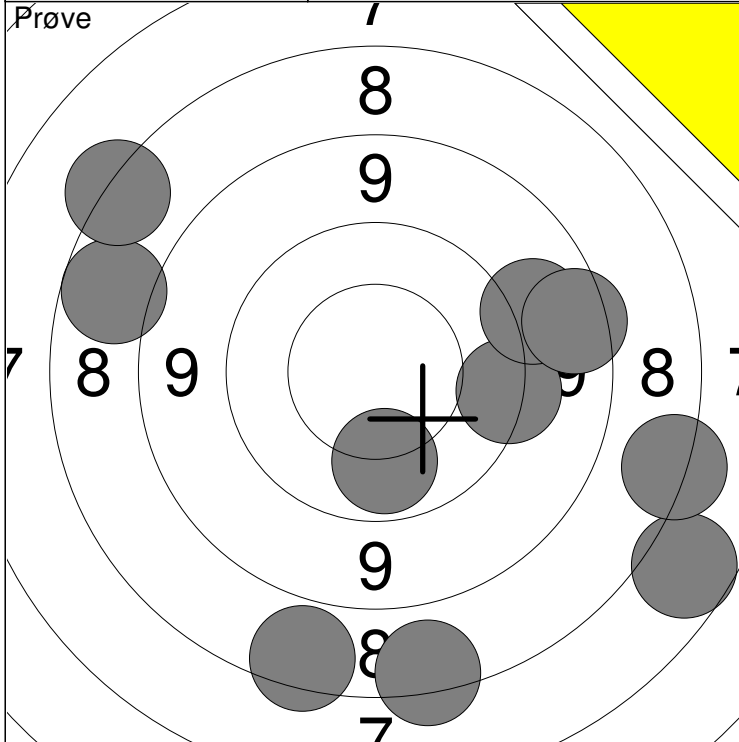

1: 7.6 ↓	6: 7.7 ↓	Serie	77
2: 7.9 ←	7: 7.5 ↗		
3: 9.5 →	8: 8.7 →	Total	0
4: 10.0 ↓	9: 6.9 ↘		
5: 9.1 →	10: 7.5 ↘		

11: 9.3 →	Serie	27
12: 8.6 ↗		
13: 10.1 ↓	Total	0

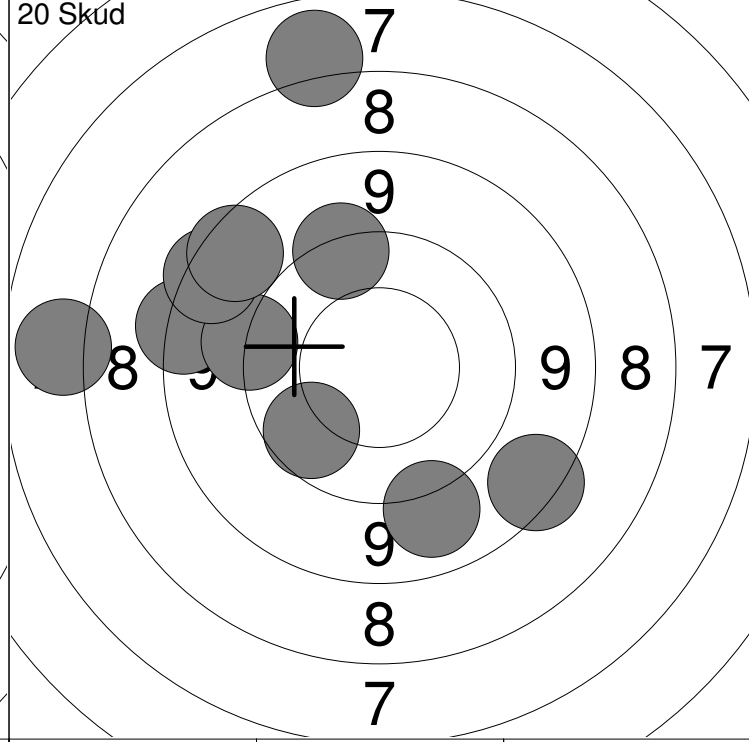
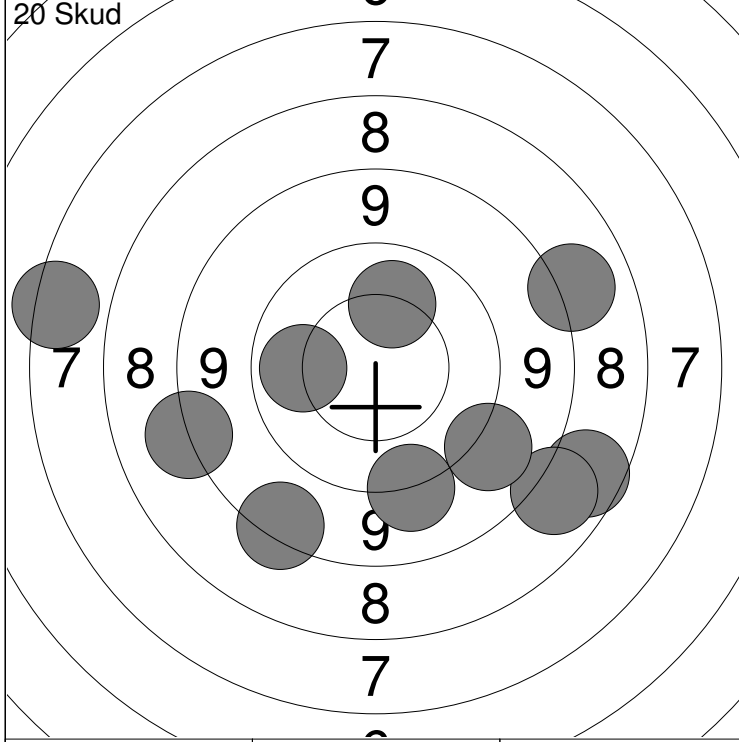

1: 10.0 ←	6: 6.6 ←	Serie	83
2: 10.1 ↑	7: 9.3 ↓		
3: 8.5 ↓	8: 7.9 ↓	Total	83
4: 8.4 ←	9: 8.1 ↓		
5: 8.2 →	10: 9.2 ↓		

11: 8.5 ←	16: 9.9 ↙	Serie	82
12: 7.1 ↑	17: 7.1 ←		
13: 9.4 ←	18: 8.6 ↓	Total	165
14: 8.7 ↗	19: 8.7 ↗		
15: 9.5 ↑	20: 9.2 ↓		

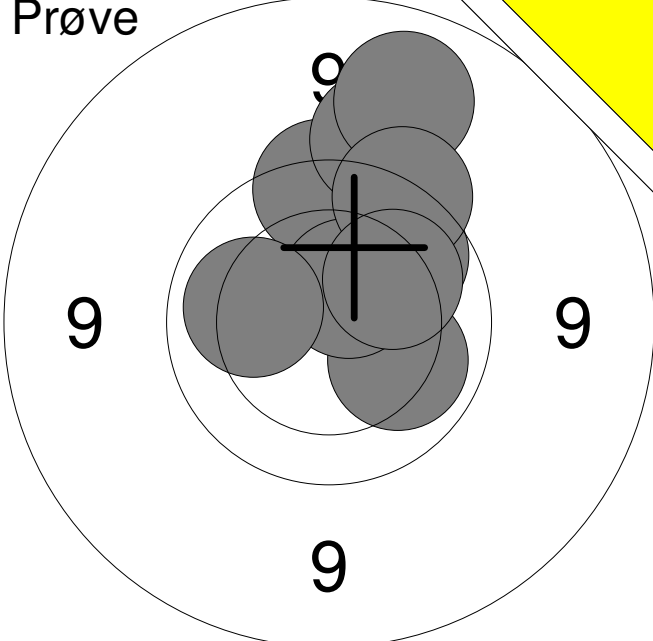
Prøve 	1:	10.1	→
	2:	9.7	↑
	3:	9.3	↑
	4:	9.1	↑
	5:	9.9	↗
	6:	10.5x	↑
	7:	9.6	↑
	8:	10.1	↗
	9:	10.1	←
	Serie		
Total			0.0

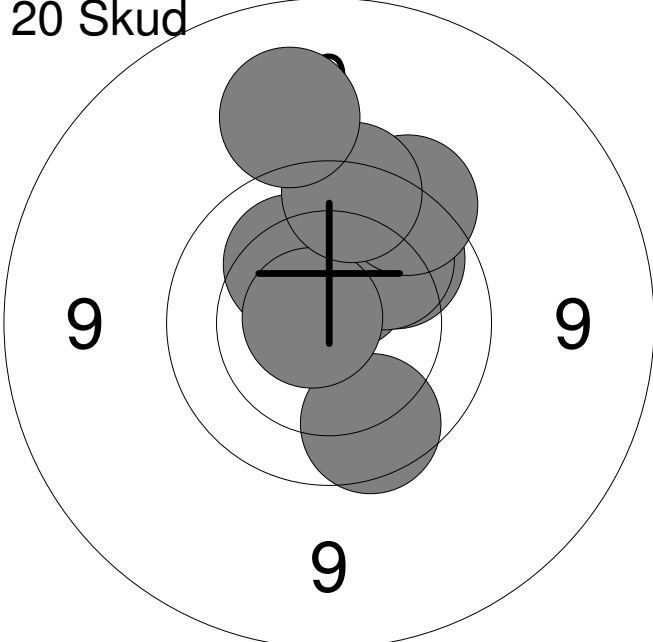
20 Skud 	1:	10.5	↑
	2:	10.0	↗
	3:	9.9	↓
	4:	9.9	↑
	5:	10.2	↖
	6:	10.0	↗
	7:	9.6	↗
	8:	10.8x	←
	9:	9.7	↑
	10:	9.2	↑
Serie			95.0
Total			95.0

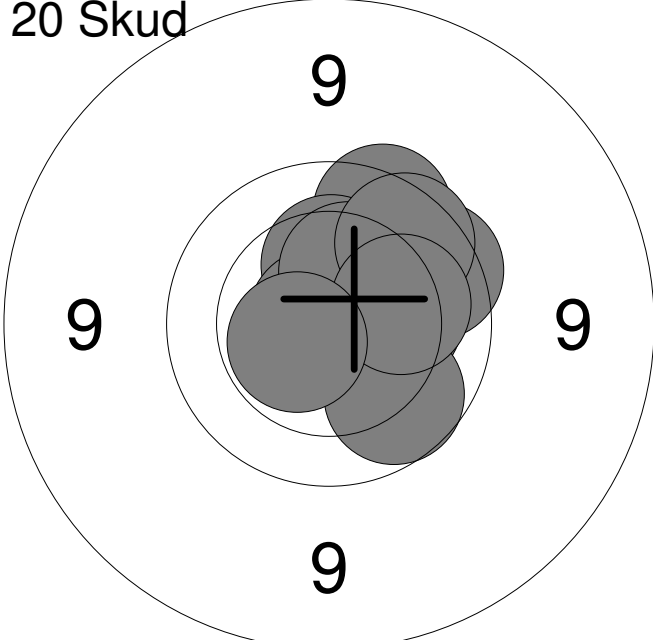
20 Skud 	11:	9.8	↑
	12:	10.3	↑
	13:	9.8	↗
	14:	10.3	→
	15:	10.8x	↖
	16:	10.3	↑
	17:	9.9	↓
	18:	9.8	↗
	19:	10.1	→
	20:	10.6x	←
Serie			96.0
Total			191.0

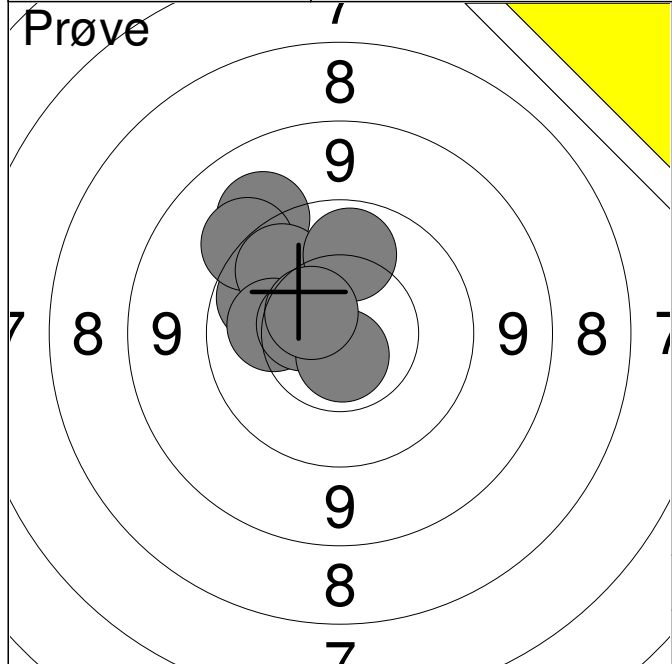

1:	10.0	↗
2:	9.3	↗
3:	9.4	↗
4:	10.0	↗
5:	10.0	↑
6:	10.2	←
7:	10.5	←
8:	10.7x	↓
9:	10.5	↗
Serie		88.0
Total		0.0

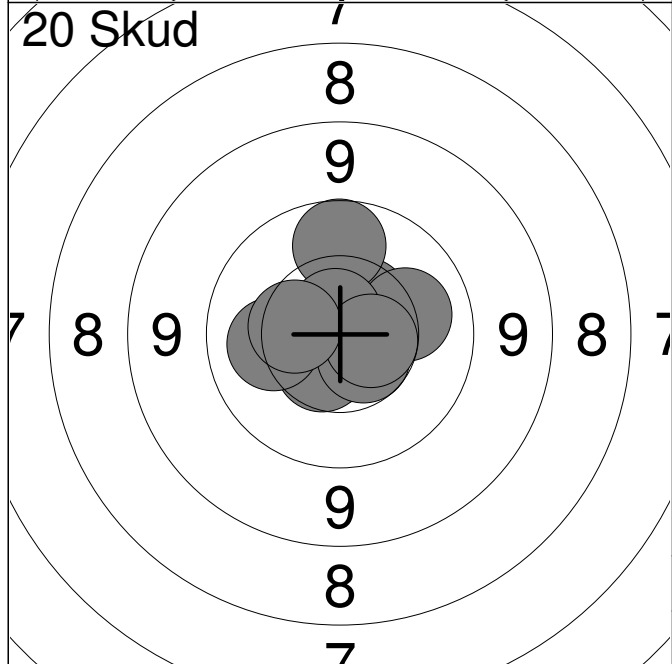

1:	10.5	↗
2:	9.9	↑
3:	10.7x	↓
4:	10.2	→
5:	10.5	↙
6:	10.7x	↑
7:	10.6	↓
8:	10.2	←
9:	10.6x	→
10:	10.4	←
Serie		99.0
Total		99.0

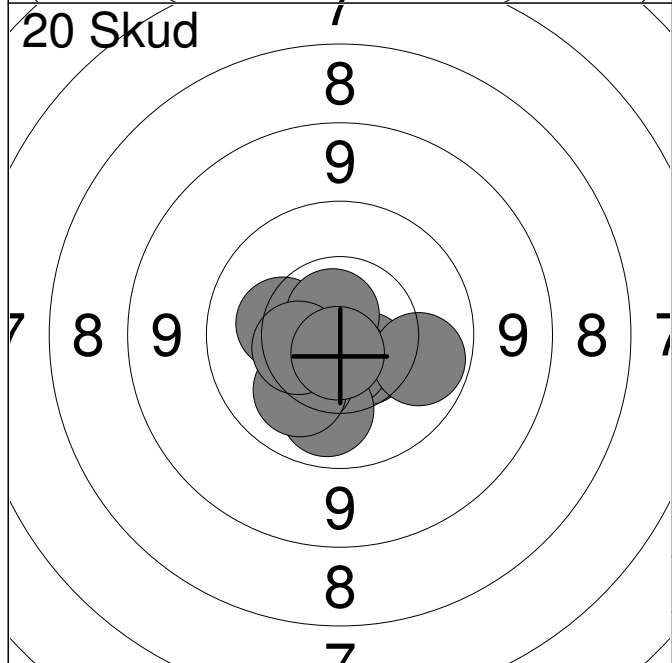

11:	10.5	↓
12:	10.3	←
13:	10.6x	↓
14:	10.1	↓
15:	10.3	↙
16:	10.7x	↑
17:	10.0	→
18:	10.2	↙
19:	10.4	←
20:	10.7x	↓
Serie		100.0
Total		199.0

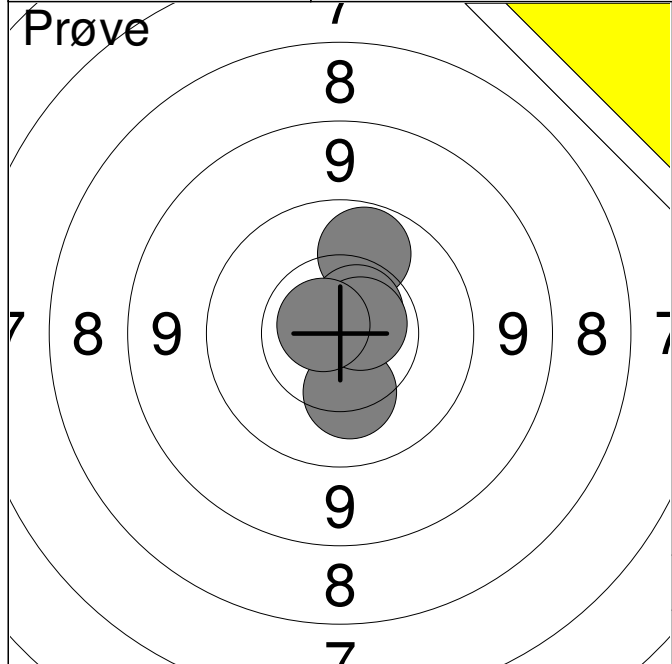

1:	10.3	↓
2:	10.0	↑
3:	10.6x	↗
4:	10.7x	→
5:	10.7x	↖
Serie		50.0
Total		0.0

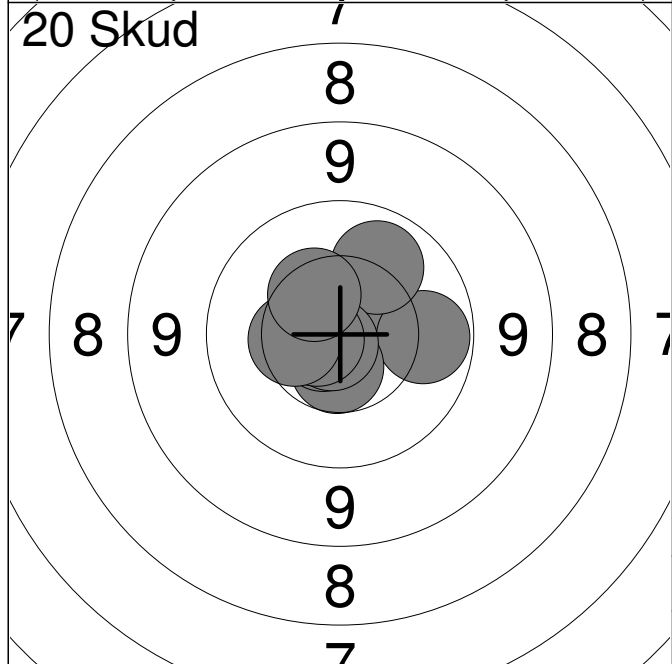

1:	10.4	↗
2:	10.0	→
3:	10.1	↗
4:	10.7x	←
5:	10.6	↓
6:	10.7x	↖
7:	10.8x	↖
8:	10.7x	←
9:	10.4	←
10:	10.4	↗
Serie		100.0
Total		100.0

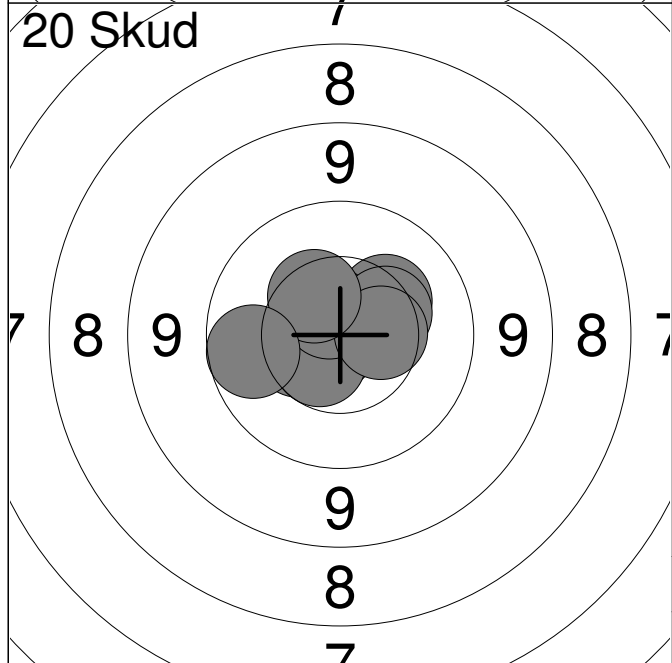

11:	10.4	←
12:	10.5	→
13:	10.8x	↖
14:	10.3	↗
15:	10.6	↖
16:	10.7x	↑
17:	10.4	→
18:	10.5	→
19:	10.4	↗
20:	9.9	←
Serie		99.0
Total		199.0

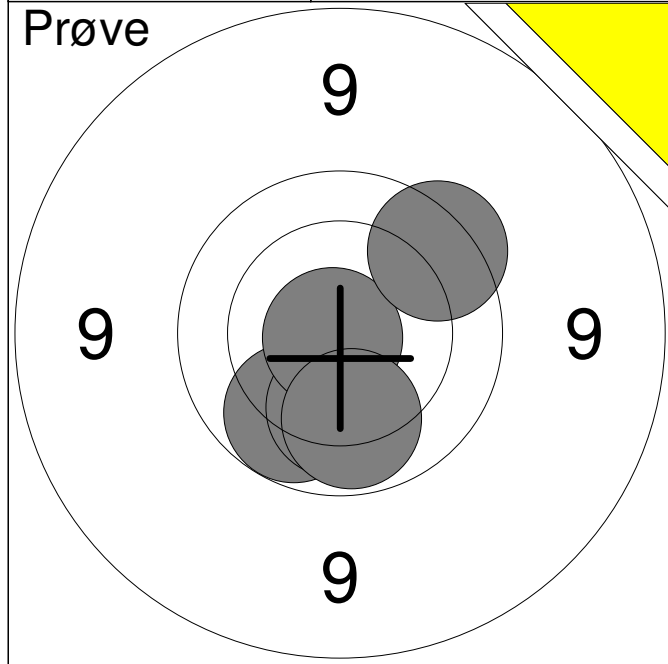

1:	10.0	↙
2:	10.1	↓
3:	10.9x	↙
4:	10.0	↓
5:	9.7	↗
Serie	49.0	
Total	0.0	

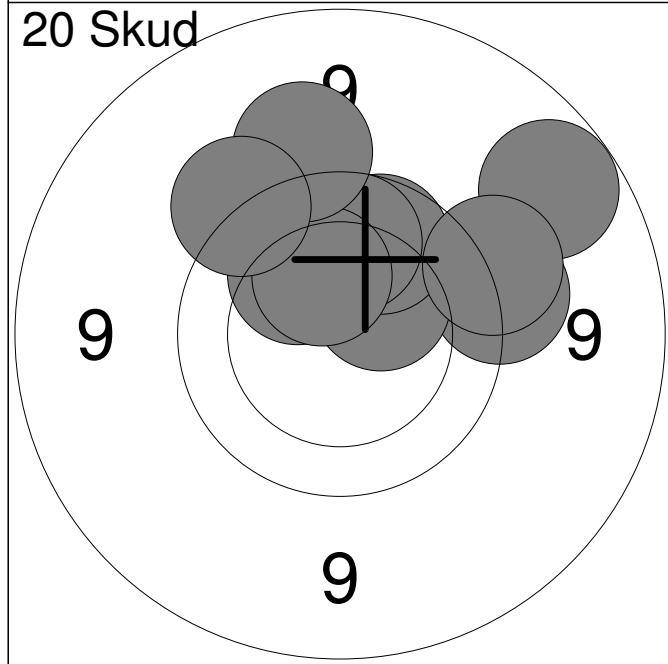

1:	9.5	→
2:	10.2	↖
3:	10.4	↗
4:	9.9	↖
5:	9.9	↑
6:	10.3	↖
7:	9.4	↑
8:	9.5	↖
9:	9.0	↗
10:	9.5	→
Serie	93.0	
Total	93.0	

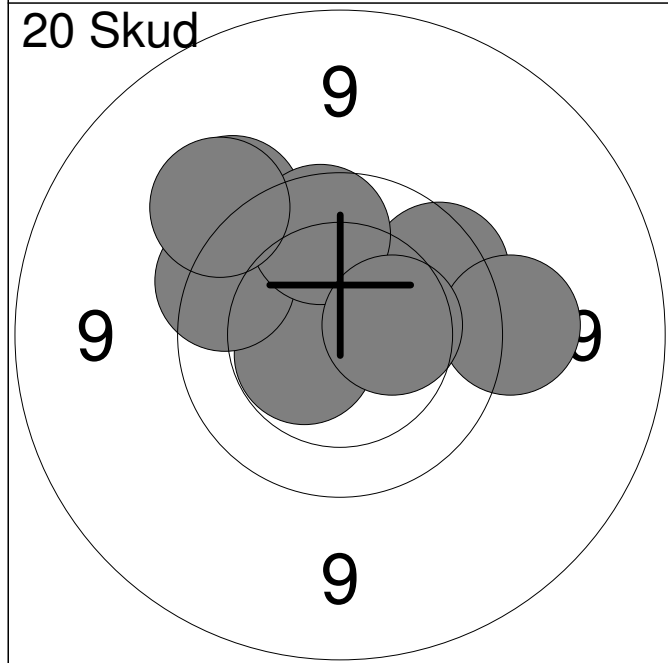

11:	10.6x	↗
12:	10.0	↖
13:	9.8	↗
14:	9.5	↖
15:	9.5	→
16:	10.5x	↙
17:	9.7	↖
18:	9.9	↑
19:	9.4	↖
20:	10.4	→
Serie	94.0	
Total	187.0	

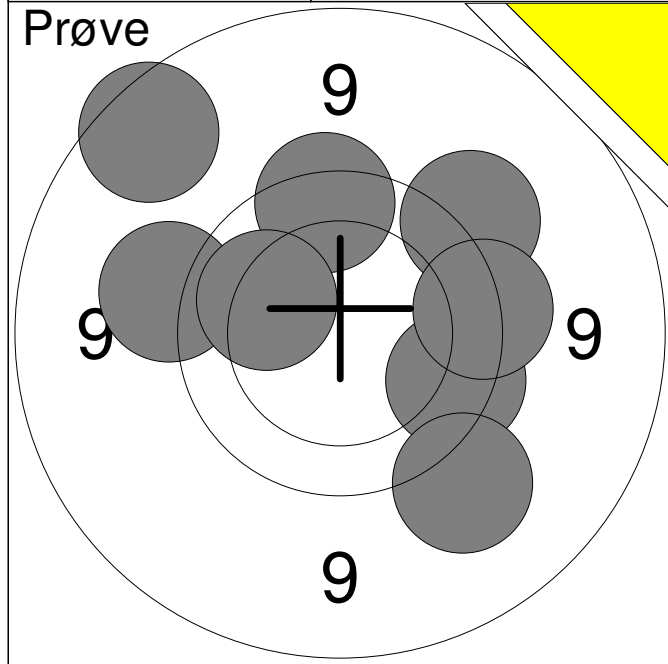

1:	9.8	→
2:	9.3	↘
3:	9.5	↗
4:	9.4	←
5:	8.9	↗
6:	9.7	↑
7:	9.6	→
8:	10.1	↖
Serie	72.0	
Total	0.0	

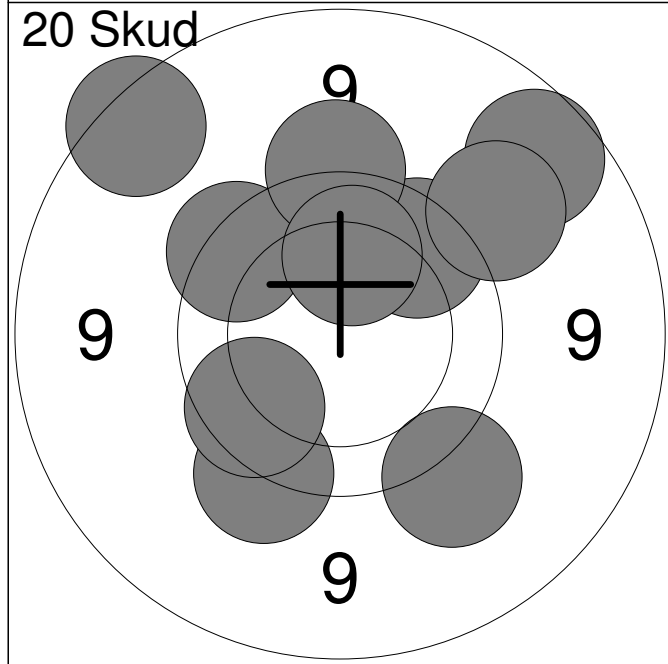

1:	9.7	↖
2:	9.5	↘
3:	9.8	↗
4:	8.9	↗
5:	9.3	↗
6:	8.8	↗
7:	9.4	↘
8:	9.5	↑
9:	10.1	↑
10:	9.8	↙
Serie	89.0	
Total	89.0	

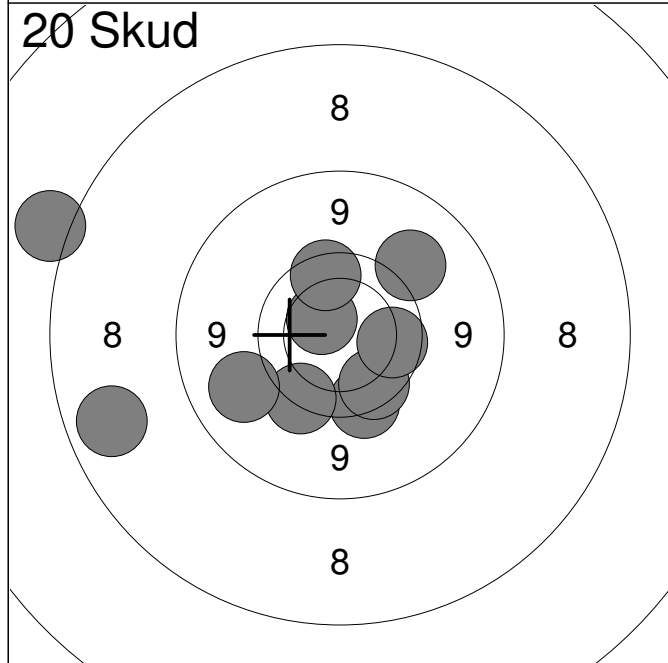

11:	9.6	↘
12:	8.0	←
13:	9.6	↘
14:	10.4	↗
15:	9.2	↙
16:	9.8	↘
17:	9.8	↑
18:	7.5	↖
19:	9.3	↗
20:	9.9	→
Serie	88.0	
Total	177.0	

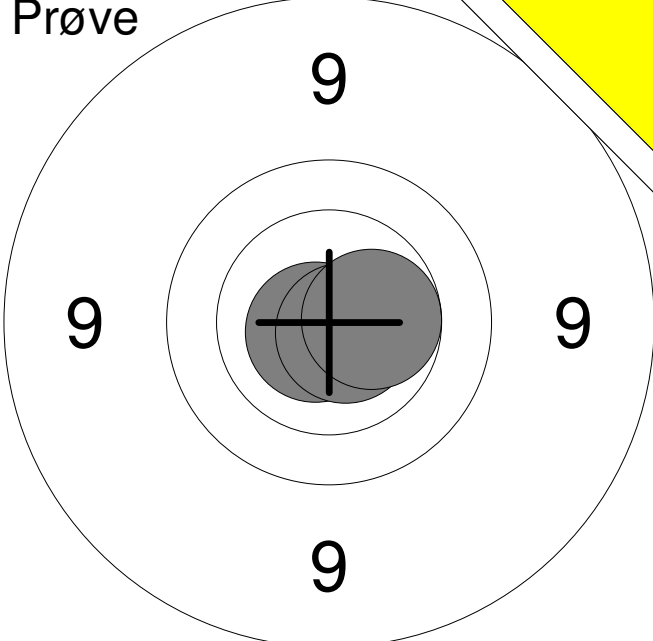
Prøve 	1:	10.8x	↙
	2:	10.7x	↘
	3:	10.5	→
	Serie		30.0
Total		0.0	

20 Skud 	1:	9.8	↘
	2:	9.7	→
	3:	10.7x	↗
	4:	10.3	↘
	5:	10.1	↗
	6:	10.5x	↗
	7:	10.2	↘
	8:	10.1	↘
	9:	10.3	↗
	10:	10.1	↗
	Serie		98.0
Total		98.0	

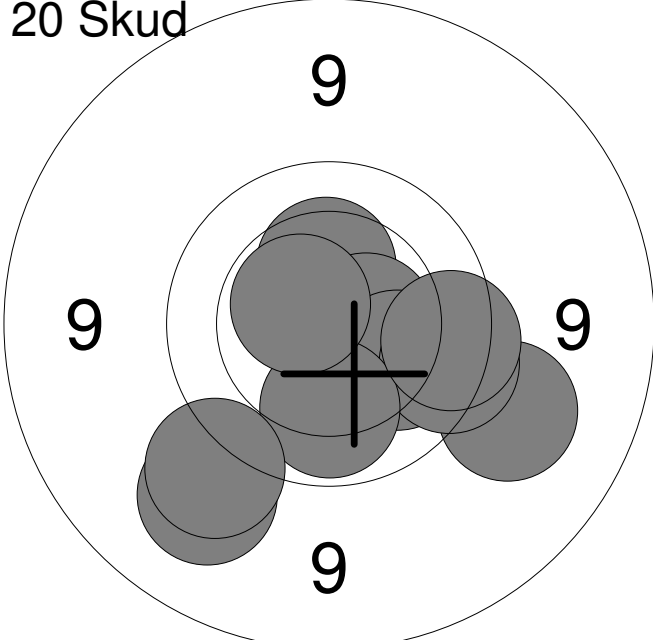
20 Skud 	11:	9.2	↙
	12:	10.3	↗
	13:	10.5x	→
	14:	10.1	↘
	15:	9.3	↘
	16:	9.7	↘
	17:	10.0	↘
	18:	10.6x	↗
	19:	9.4	↙
	20:	9.8	→
	Serie		95.0
Total		193.0	

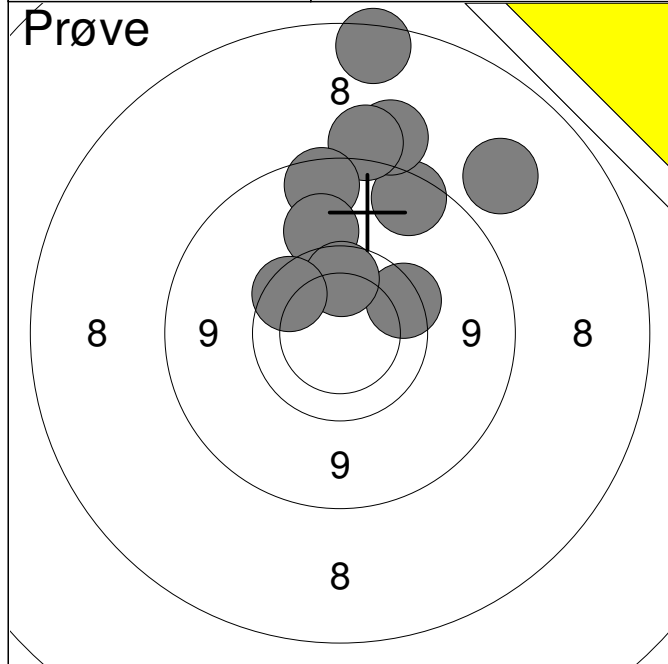

1:	8.8	↗
2:	8.5	↑
3:	8.3	↗
4:	8.5	↑
5:	7.8	↑
6:	8.9	↑
7:	9.7	↗
8:	9.3	↑
9:	9.9	↑
10:	9.8	↘
Serie		83.0
Total		0.0

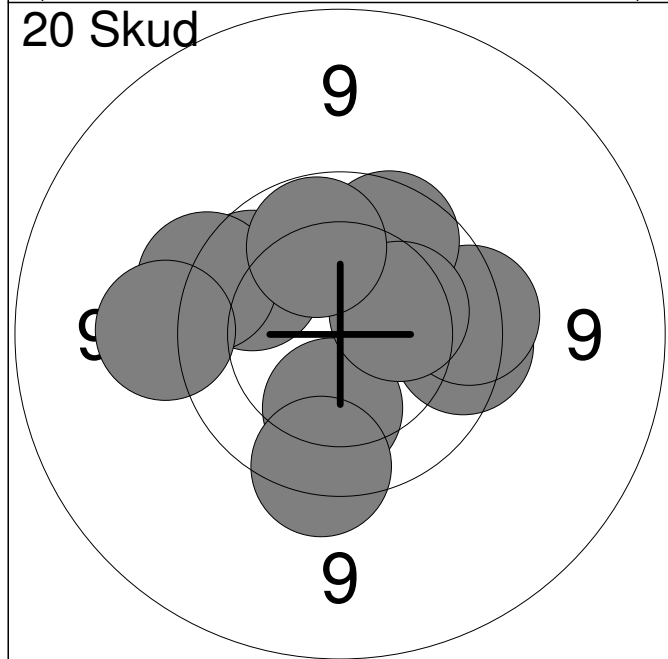

1:	9.8	→
2:	9.9	↗
3:	9.7	→
4:	9.9	↗
5:	10.1	↓
6:	9.6	↖
7:	9.4	←
8:	9.7	↓
9:	10.3	↗
10:	10.0	↑
Serie		93.0
Total		93.0

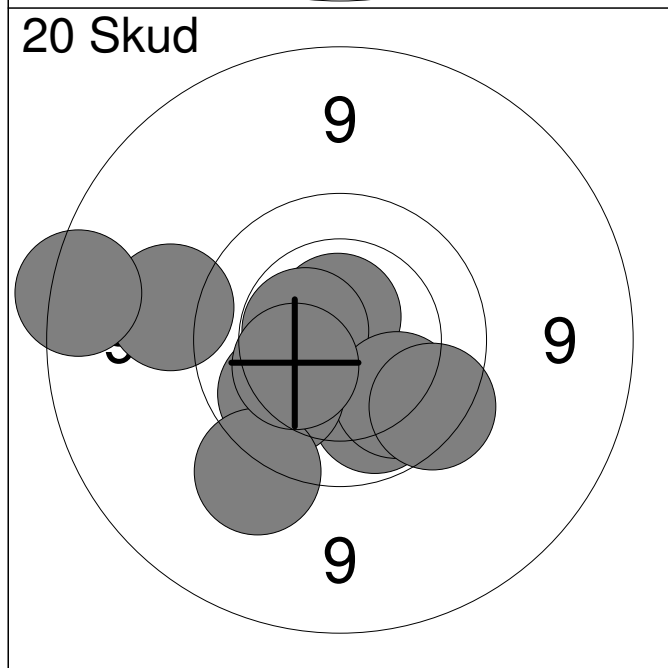

11:	10.0	↓
12:	10.7x	↑
13:	9.3	←
14:	10.5x	↖
15:	10.0	↘
16:	10.0	↖
17:	9.5	↖
18:	8.8	←
19:	9.7	↘
20:	10.3	↖
Serie		95.0
Total		188.0

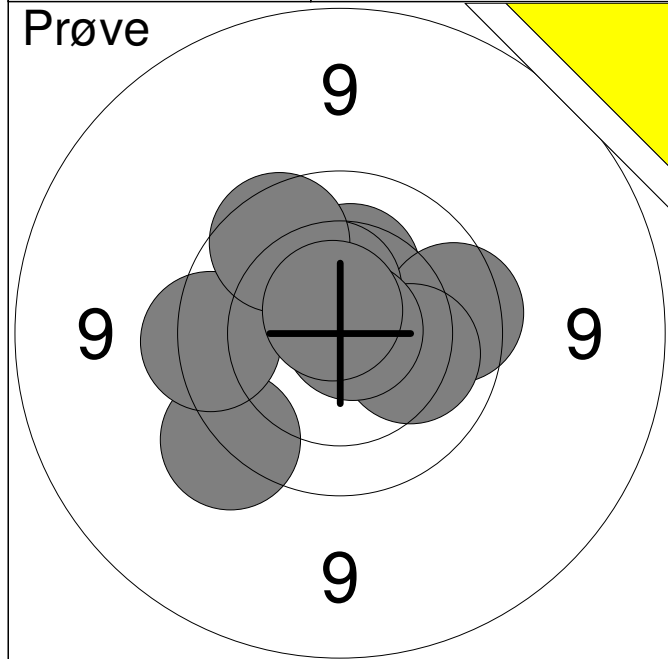

1:	9.6	↙
2:	9.7	←
3:	10.8x	→
4:	10.3	↑
5:	9.8	→
6:	10.5	↑
7:	9.9	↗
8:	10.2	→
9:	10.8x	→
10:	10.7x	↑

Serie	96.0
Total	0.0

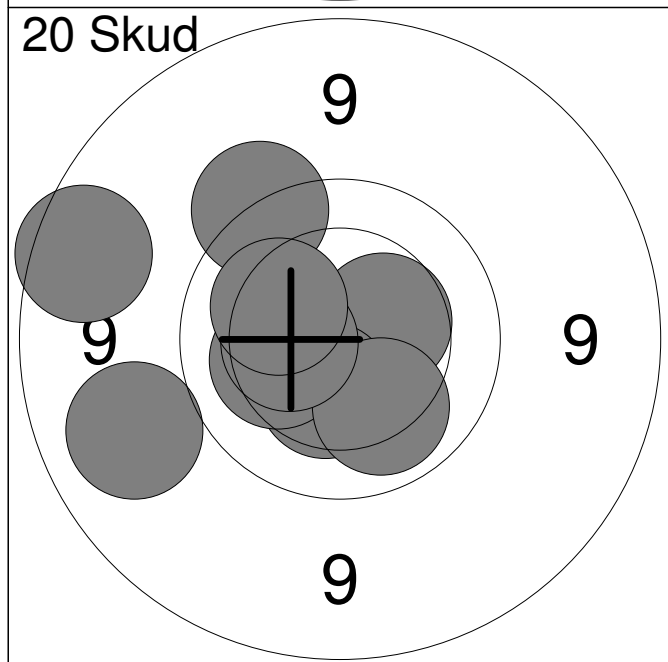

1:	9.1	↙
2:	10.4	←
3:	8.9	←
4:	10.4	→
5:	10.4	↓
6:	10.2	←
7:	10.1	↓
8:	10.4	←
9:	9.6	↗
10:	10.2	↗

Serie	96.0
Total	96.0

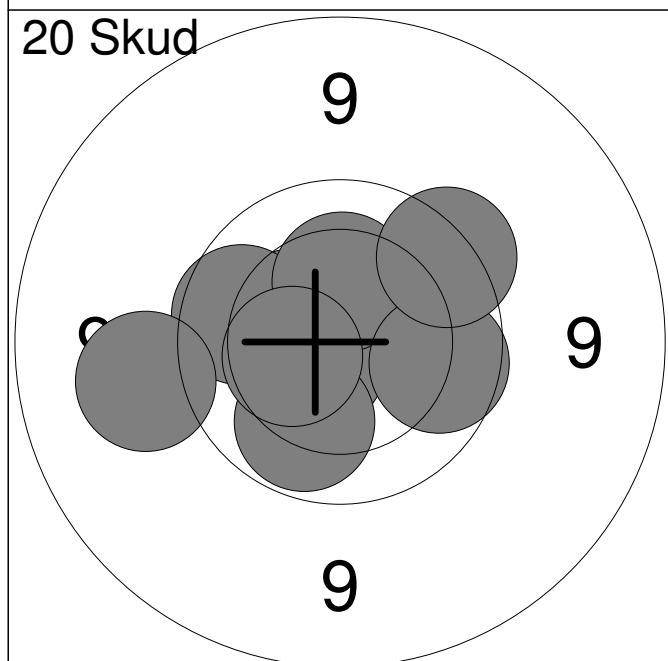

11:	10.6x	←
12:	10.4	↗
13:	10.6x	↙
14:	9.9	←
15:	10.0	↓
16:	9.3	←
17:	10.3	↑
18:	9.9	→
19:	9.7	↗
20:	10.4	←

Serie	96.0
Total	192.0

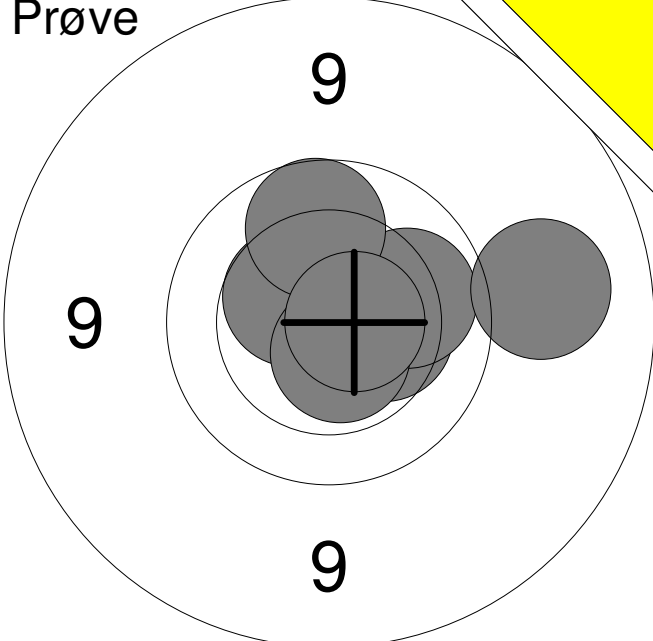
<p>Prøve</p> 	<table style="width:100%; border-collapse: collapse;"> <tr><td style="width:10%;">1:</td><td style="width:70%;">10.5</td><td style="width:20%; text-align: right;">↗</td></tr> <tr><td>2:</td><td>10.4</td><td style="text-align: right;">→</td></tr> <tr><td>3:</td><td>10.1</td><td style="text-align: right;">→</td></tr> <tr><td>4:</td><td>10.6x</td><td style="text-align: right;">↓</td></tr> <tr><td>5:</td><td>9.2</td><td style="text-align: right;">→</td></tr> <tr><td>6:</td><td>9.9</td><td style="text-align: right;">↑</td></tr> <tr><td>7:</td><td>10.7x</td><td style="text-align: right;">→</td></tr> </table>	1:	10.5	↗	2:	10.4	→	3:	10.1	→	4:	10.6x	↓	5:	9.2	→	6:	9.9	↑	7:	10.7x	→
1:	10.5	↗																				
2:	10.4	→																				
3:	10.1	→																				
4:	10.6x	↓																				
5:	9.2	→																				
6:	9.9	↑																				
7:	10.7x	→																				
<table style="width:100%; border-collapse: collapse;"> <tr> <td style="width:10%;">Serie</td> <td style="width:70%;"></td> <td style="width:20%; text-align: right;">68.0</td> </tr> <tr> <td>Total</td> <td></td> <td style="text-align: right;">0.0</td> </tr> </table>		Serie		68.0	Total		0.0															
Serie		68.0																				
Total		0.0																				

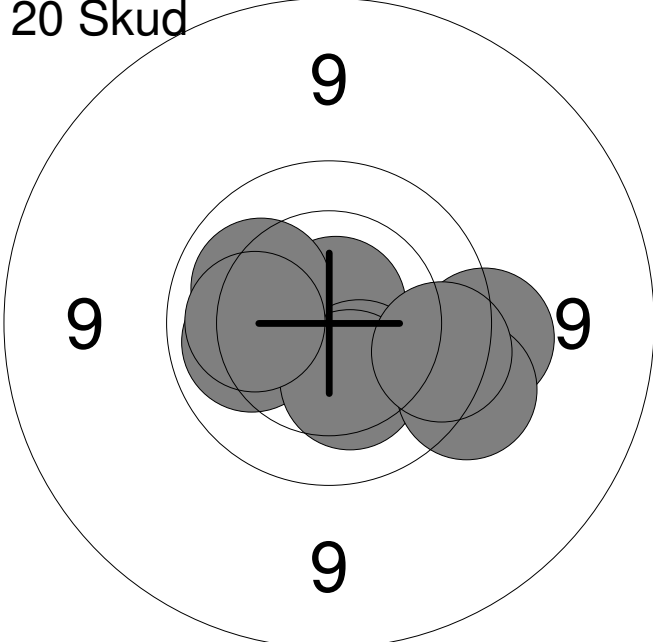
<p>20 Skud</p> 	<table style="width:100%; border-collapse: collapse;"> <tr><td style="width:10%;">1:</td><td style="width:70%;">10.4</td><td style="width:20%; text-align: right;">←</td></tr> <tr><td>2:</td><td>9.6</td><td style="text-align: right;">→</td></tr> <tr><td>3:</td><td>10.8x</td><td style="text-align: right;">↑</td></tr> <tr><td>4:</td><td>10.3</td><td style="text-align: right;">↓</td></tr> <tr><td>5:</td><td>10.1</td><td style="text-align: right;">←</td></tr> <tr><td>6:</td><td>10.3</td><td style="text-align: right;">↓</td></tr> <tr><td>7:</td><td>10.1</td><td style="text-align: right;">↑</td></tr> <tr><td>8:</td><td>9.6</td><td style="text-align: right;">→</td></tr> <tr><td>9:</td><td>9.8</td><td style="text-align: right;">→</td></tr> <tr><td>10:</td><td>10.1</td><td style="text-align: right;">←</td></tr> </table>	1:	10.4	←	2:	9.6	→	3:	10.8x	↑	4:	10.3	↓	5:	10.1	←	6:	10.3	↓	7:	10.1	↑	8:	9.6	→	9:	9.8	→	10:	10.1	←
1:	10.4	←																													
2:	9.6	→																													
3:	10.8x	↑																													
4:	10.3	↓																													
5:	10.1	←																													
6:	10.3	↓																													
7:	10.1	↑																													
8:	9.6	→																													
9:	9.8	→																													
10:	10.1	←																													
<table style="width:100%; border-collapse: collapse;"> <tr> <td style="width:10%;">Serie</td> <td style="width:70%;"></td> <td style="width:20%; text-align: right;">97.0</td> </tr> <tr> <td>Total</td> <td></td> <td style="text-align: right;">97.0</td> </tr> </table>		Serie		97.0	Total		97.0																								
Serie		97.0																													
Total		97.0																													

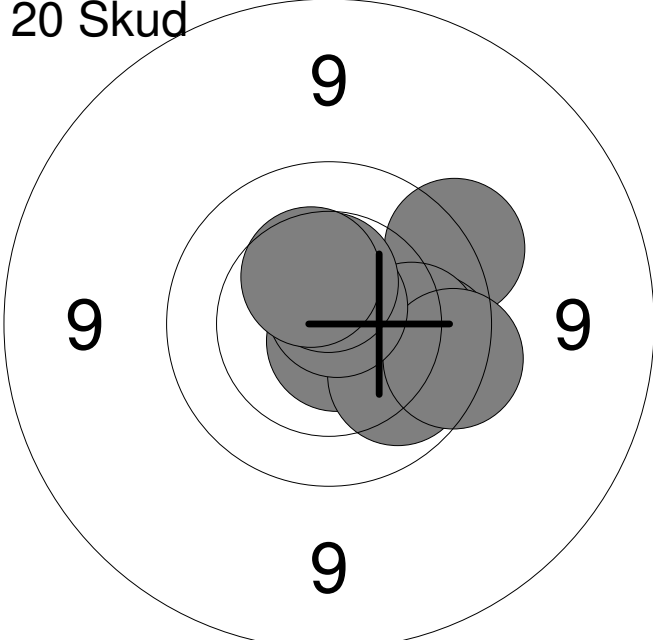
<p>20 Skud</p> 	<table style="width:100%; border-collapse: collapse;"> <tr><td style="width:10%;">11:</td><td style="width:70%;">9.6</td><td style="width:20%; text-align: right;">↗</td></tr> <tr><td>12:</td><td>9.9</td><td style="text-align: right;">→</td></tr> <tr><td>13:</td><td>10.7x</td><td style="text-align: right;">↑</td></tr> <tr><td>14:</td><td>10.1</td><td style="text-align: right;">→</td></tr> <tr><td>15:</td><td>10.7x</td><td style="text-align: right;">↓</td></tr> <tr><td>16:</td><td>10.0</td><td style="text-align: right;">↓</td></tr> <tr><td>17:</td><td>9.7</td><td style="text-align: right;">→</td></tr> <tr><td>18:</td><td>10.7x</td><td style="text-align: right;">↑</td></tr> <tr><td>19:</td><td>10.5x</td><td style="text-align: right;">↑</td></tr> <tr><td>20:</td><td>10.4</td><td style="text-align: right;">↑</td></tr> </table>	11:	9.6	↗	12:	9.9	→	13:	10.7x	↑	14:	10.1	→	15:	10.7x	↓	16:	10.0	↓	17:	9.7	→	18:	10.7x	↑	19:	10.5x	↑	20:	10.4	↑
11:	9.6	↗																													
12:	9.9	→																													
13:	10.7x	↑																													
14:	10.1	→																													
15:	10.7x	↓																													
16:	10.0	↓																													
17:	9.7	→																													
18:	10.7x	↑																													
19:	10.5x	↑																													
20:	10.4	↑																													
<table style="width:100%; border-collapse: collapse;"> <tr> <td style="width:10%;">Serie</td> <td style="width:70%;"></td> <td style="width:20%; text-align: right;">97.0</td> </tr> <tr> <td>Total</td> <td></td> <td style="text-align: right;">194.0</td> </tr> </table>		Serie		97.0	Total		194.0																								
Serie		97.0																													
Total		194.0																													

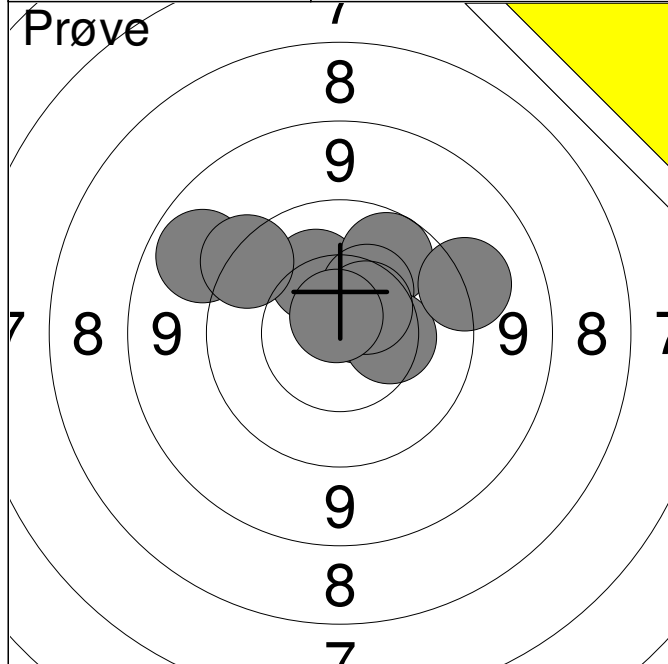

1:	10.2	↑
2:	9.0	↖
3:	9.6	↖
4:	10.7x	↗
5:	9.9	↗
6:	10.4	↗
7:	10.4	→
8:	9.3	→
9:	10.5	↗
10:	10.7x	↑
Serie		96.0
Total		0.0

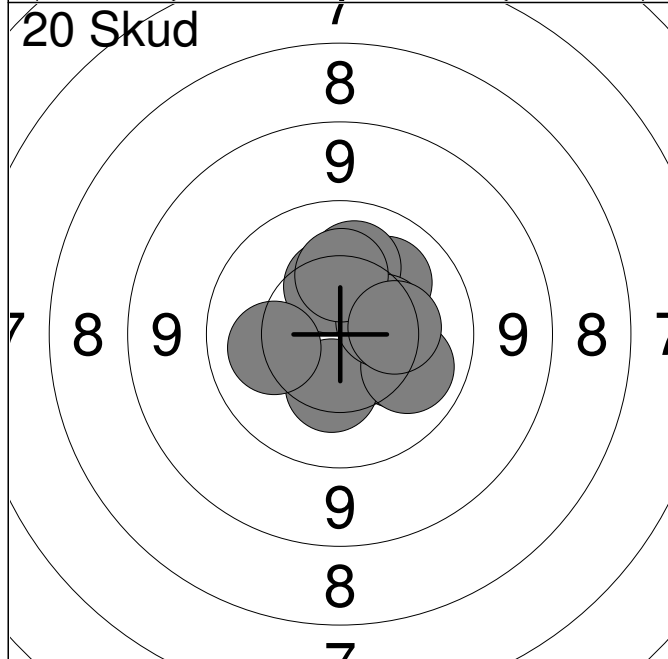

1:	10.2	→
2:	10.4	↓
3:	10.1	→
4:	10.2	↗
5:	10.2	↑
6:	10.4	↑
7:	10.4	→
8:	10.3	↑
9:	10.3	→
10:	10.2	←
Serie		100.0
Total		100.0

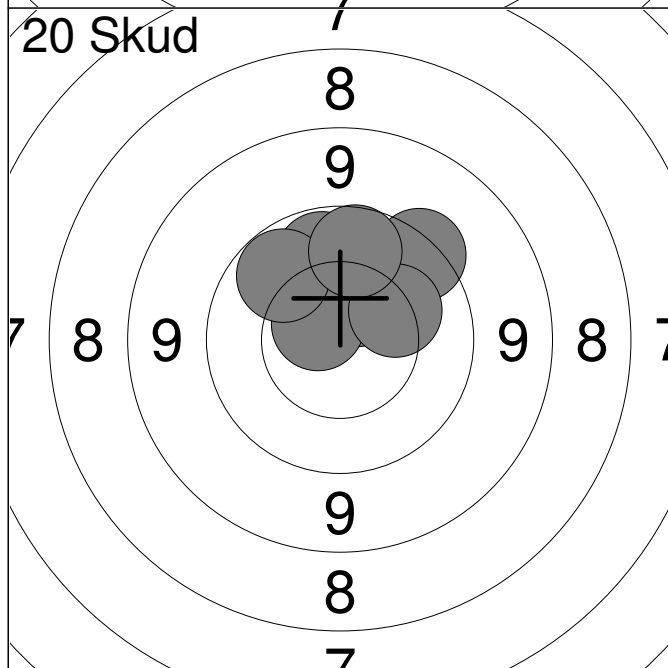

11:	10.4	↑
12:	9.6	↗
13:	10.5	↖
14:	10.0	↑
15:	10.3	↑
16:	10.3	↑
17:	10.6x	↖
18:	10.0	↖
19:	10.2	→
20:	9.9	↑
Serie		98.0
Total		198.0

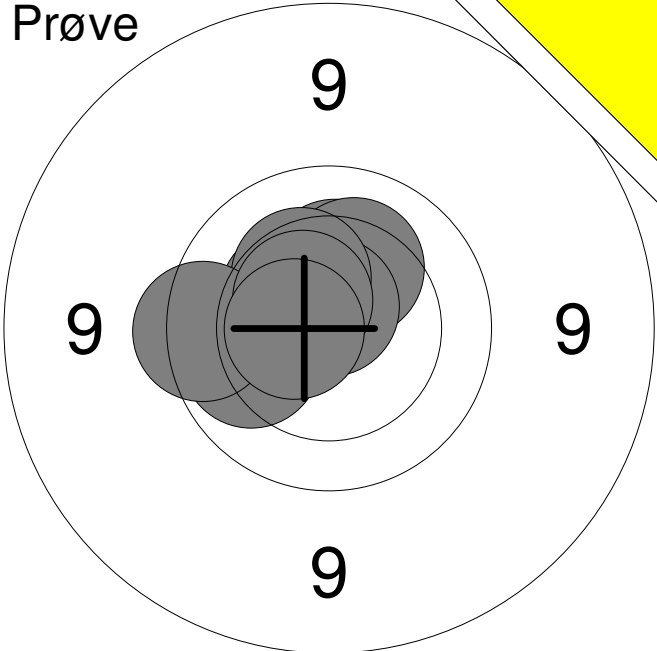
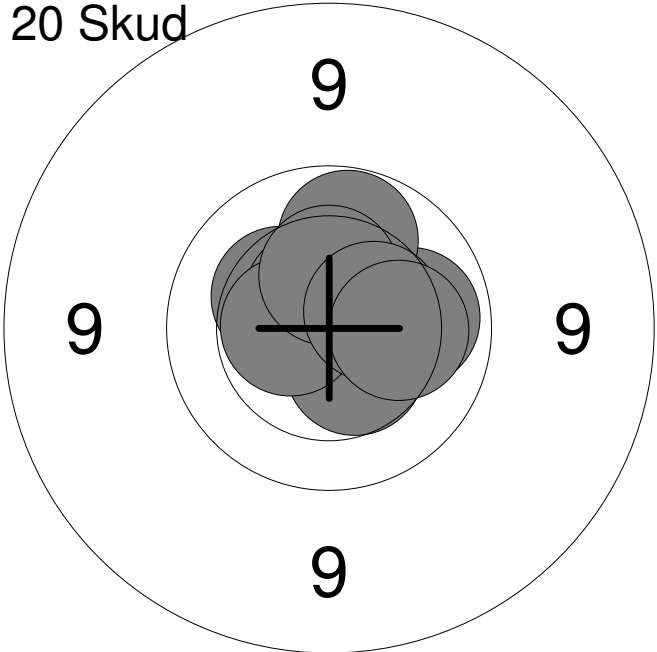
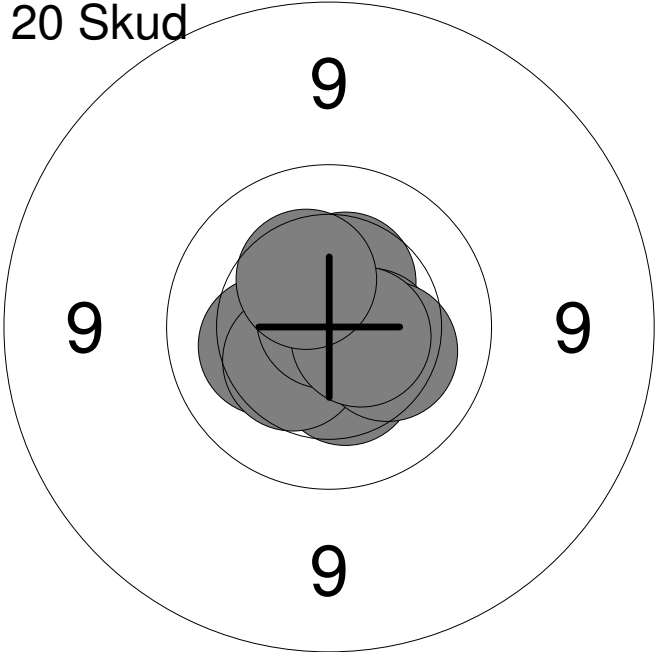
Hold	Skive	Frederik Axelsen	
79	6	15m	Vester Hassing Skf. MJ1
24.10.2013	15 meter riffelstævne 2013	Aalborg Skyttekreds	
Prøve 	1:	10.1	←
	2:	10.3	↑
	3:	10.4	↖
	4:	10.2	↗
	5:	10.7x	↑
	6:	10.3	↗
	7:	9.7	←
	8:	10.5x	↗
	9:	10.6x	←
	Serie		89.0
Total		0.0	
20 Skud 	1:	10.8x	↗
	2:	10.3	↗
	3:	10.1	→
	4:	10.0	↑
	5:	10.5	↘
	6:	10.6x	↗
	7:	10.5x	←
	8:	10.4	↑
	9:	10.4	→
	10:	10.2	→
Serie		100.0	
Total		100.0	
20 Skud 	11:	10.4	↘
	12:	10.7x	←
	13:	10.3	←
	14:	10.4	↖
	15:	10.4	↑
	16:	10.5x	→
	17:	10.3	→
	18:	10.9x	↑
	19:	10.6x	→
	20:	10.4	↗
Serie		100.0	
Total		200.0	

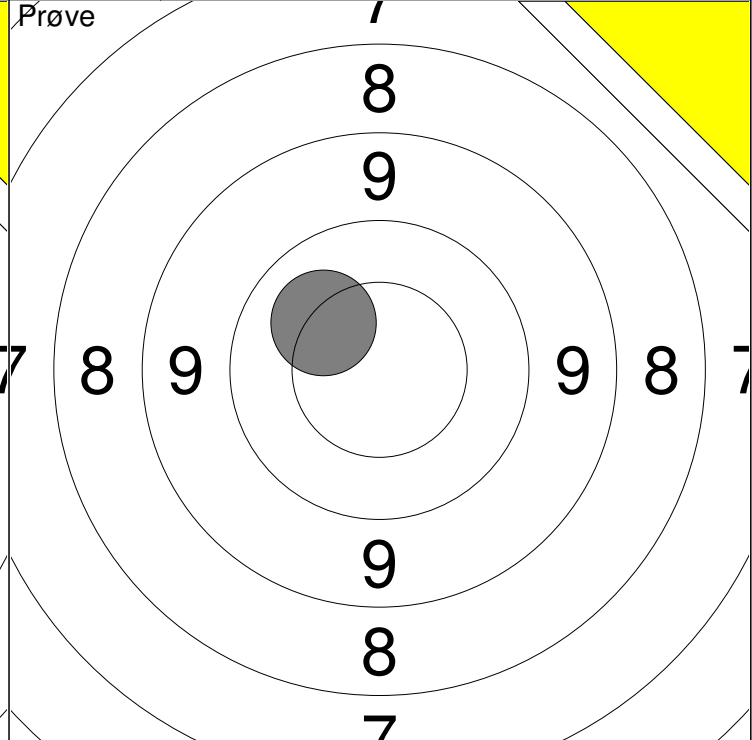
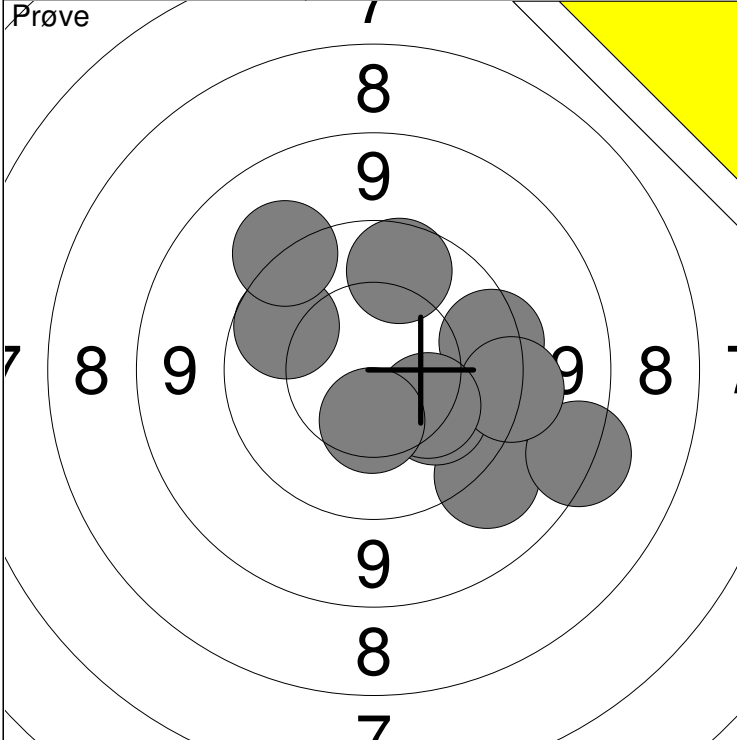

1: 9.3 ↘	6: 9.9 ↗	Serie	92
2: 8.5 ↘	7: 9.4 ↗		
3: 9.7 →	8: 9.9 ↗	Total	0
4: 10.2 ↘	9: 10.3 ↘		
5: 9.5 →	10: 10.4 ↓		

11: 10.2 ↗	Serie	10
	Total	0

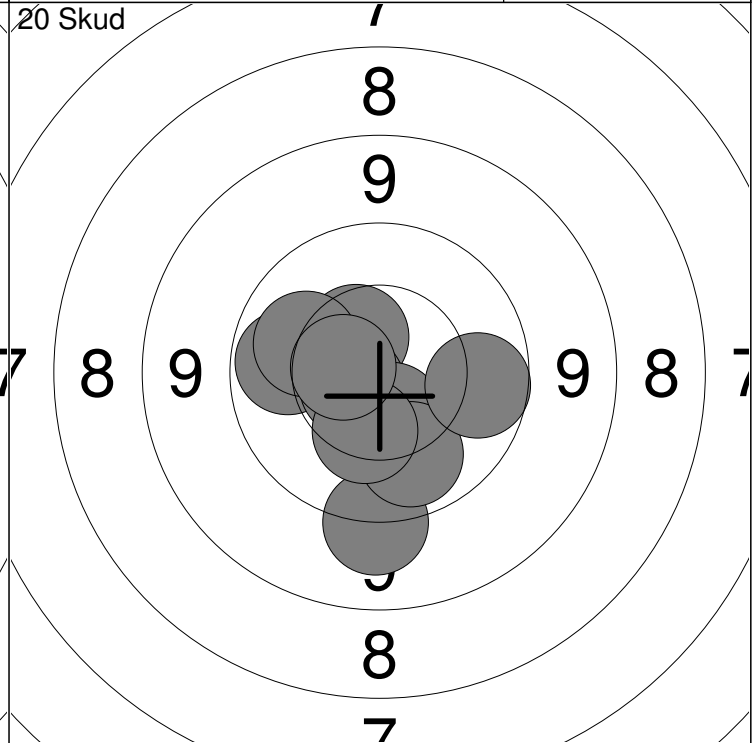
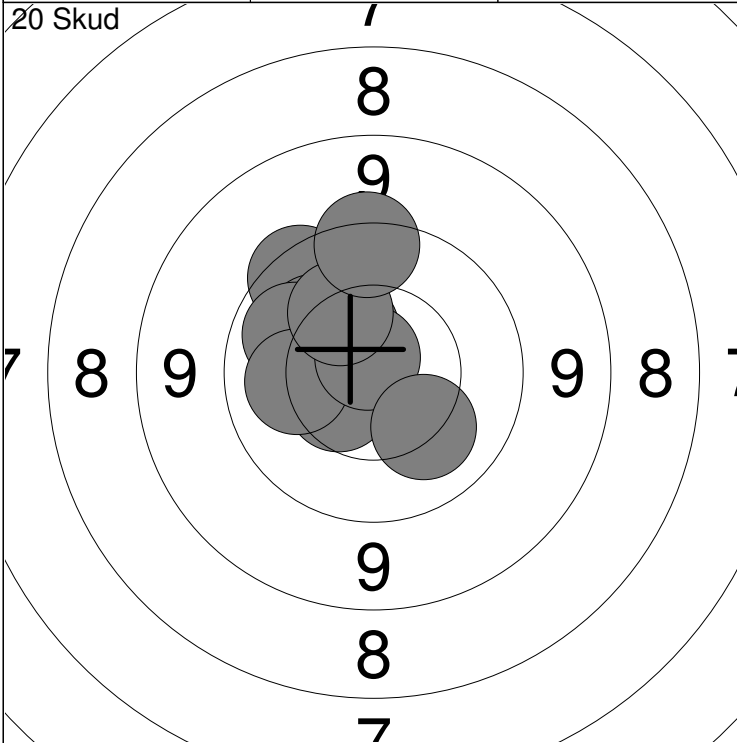

1: 9.7 ↗	6: 10.2 ←	Serie	98
2: 10.4 ↗	7: 10.8x ↗		
3: 10.2 ↗	8: 10.2 ↗	Total	98
4: 10.1 ↗	9: 10.2 ↘		
5: 10.5 ↙	10: 9.6 ↗		

11: 10.0 ←	16: 10.1 ←	Serie	98
12: 10.5 ↗	17: 10.0 ↘		
13: 10.6x ←	18: 10.3 ↘	Total	196
14: 9.3 ↓	19: 9.9 →		
15: 10.5 ↓	20: 10.6 ←		

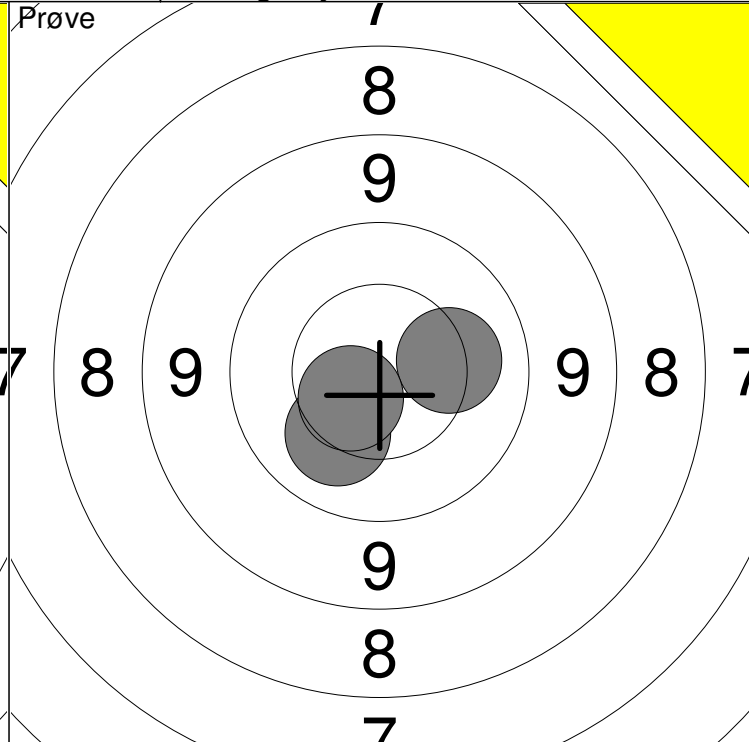
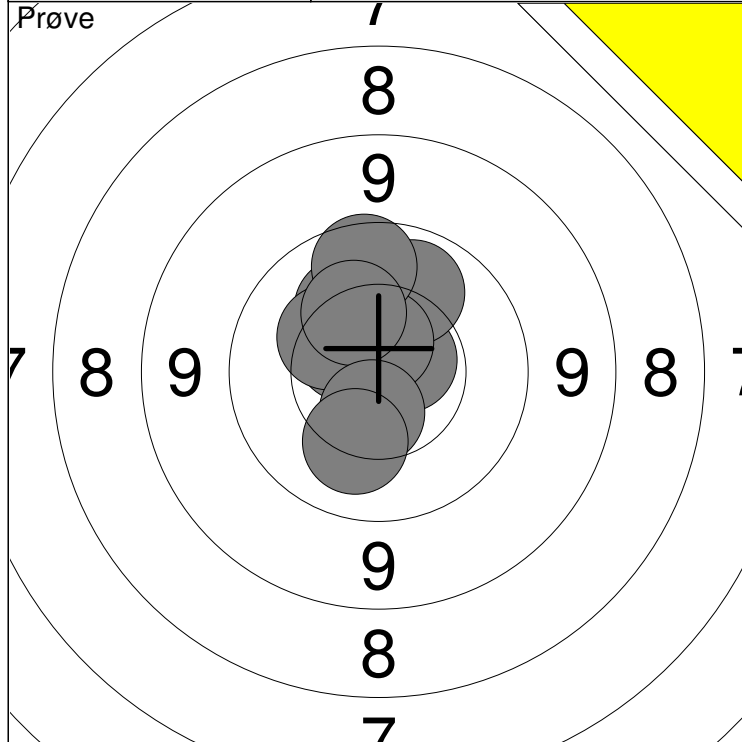

1: 10.7x →	6: 10.3 ↖	Serie	99
2: 10.2 ↗	7: 9.8 ↗		
3: 10.1 ↗	8: 10.3 ↗	Total	0
4: 10.6 ↖	9: 10.5 ↓		
5: 10.6x ↑	10: 10.2 ↓		

11: 10.2 ↙	Serie	30
12: 10.2 →		
13: 10.5 ↙	Total	0

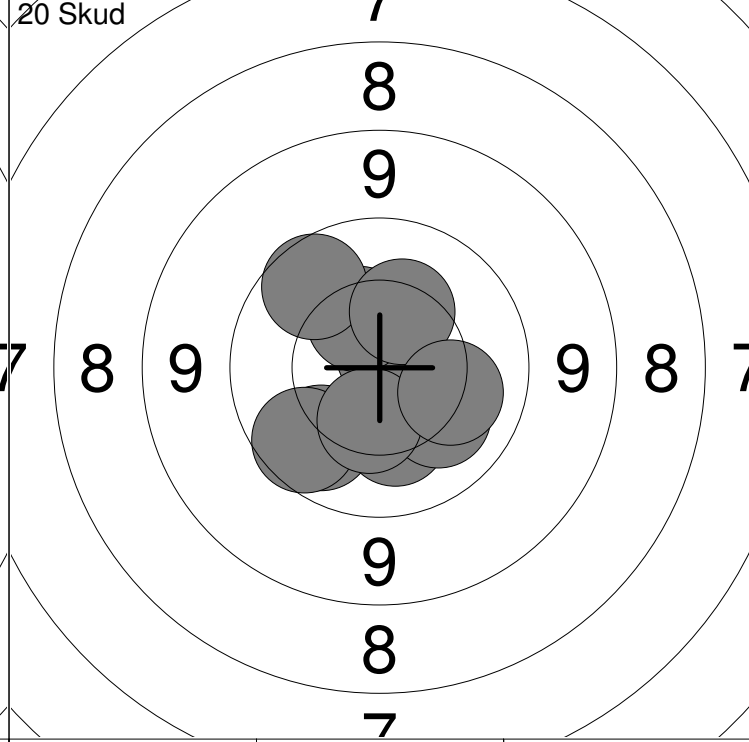
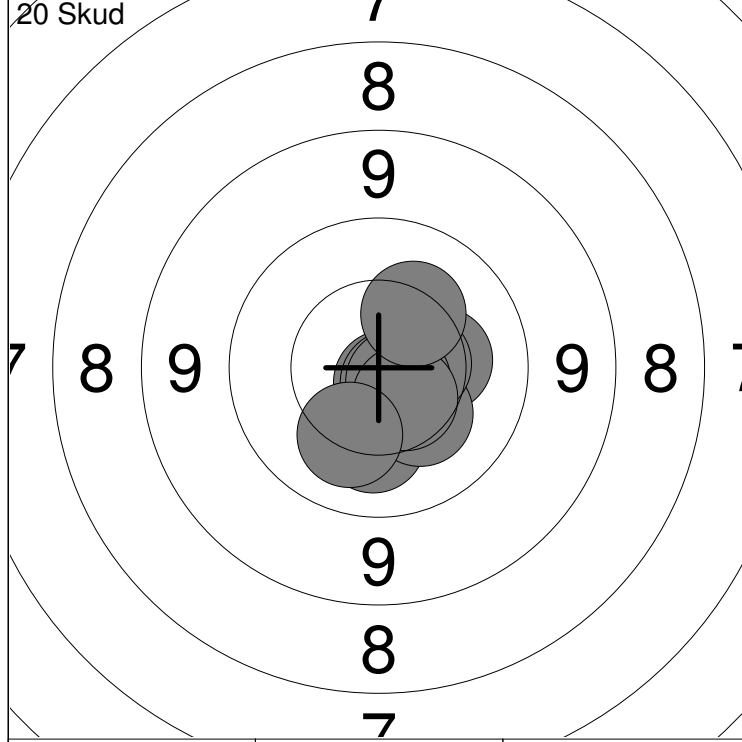

1: 10.2 ↓	6: 10.5 →	Serie	100
2: 10.3 →	7: 10.7x ↘		
3: 10.8x ↘	8: 10.5 ↘	Total	100
4: 10.3 ↘	9: 10.2 ↘		
5: 10.7x ↘	10: 10.3 ↗		

11: 10.0 ↙	16: 10.4 ↗	Serie	98
12: 10.3 ↓	17: 10.4 ↓		
13: 9.9 ↙	18: 9.9 ↗	Total	198
14: 10.8x ↗	19: 10.3 ↗		
15: 10.2 ↘	20: 10.2 →		

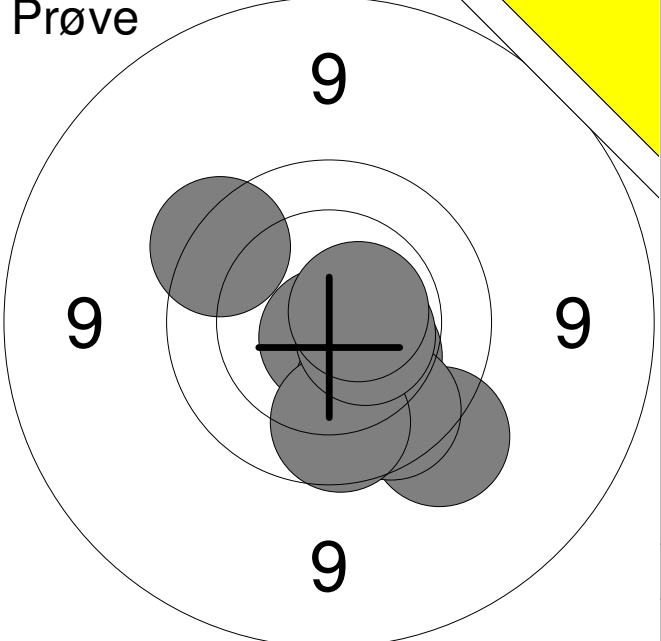
<p>Prøve</p> 	<table style="width:100%; border-collapse: collapse;"> <tr><td style="width:10%;">1:</td><td style="width:70%;">10.4</td><td style="width:20%; text-align: right;">↘</td></tr> <tr><td>2:</td><td>9.5</td><td style="text-align: right;">↘</td></tr> <tr><td>3:</td><td>10.8x</td><td style="text-align: right;">↓</td></tr> <tr><td>4:</td><td>10.1</td><td style="text-align: right;">↘</td></tr> <tr><td>5:</td><td>9.9</td><td style="text-align: right;">↘</td></tr> <tr><td>6:</td><td>9.7</td><td style="text-align: right;">↗</td></tr> <tr><td>7:</td><td>9.9</td><td style="text-align: right;">↓</td></tr> <tr><td>8:</td><td>10.5x</td><td style="text-align: right;">→</td></tr> <tr><td>9:</td><td>10.6x</td><td style="text-align: right;">→</td></tr> </table>	1:	10.4	↘	2:	9.5	↘	3:	10.8x	↓	4:	10.1	↘	5:	9.9	↘	6:	9.7	↗	7:	9.9	↓	8:	10.5x	→	9:	10.6x	→
1:	10.4	↘																										
2:	9.5	↘																										
3:	10.8x	↓																										
4:	10.1	↘																										
5:	9.9	↘																										
6:	9.7	↗																										
7:	9.9	↓																										
8:	10.5x	→																										
9:	10.6x	→																										
<table style="width:100%; border-collapse: collapse;"> <tr> <td style="width:10%;">Serie</td> <td style="width:70%;"></td> <td style="width:20%; text-align: right;">86.0</td> </tr> <tr> <td>Total</td> <td></td> <td style="text-align: right;">0.0</td> </tr> </table>		Serie		86.0	Total		0.0																					
Serie		86.0																										
Total		0.0																										

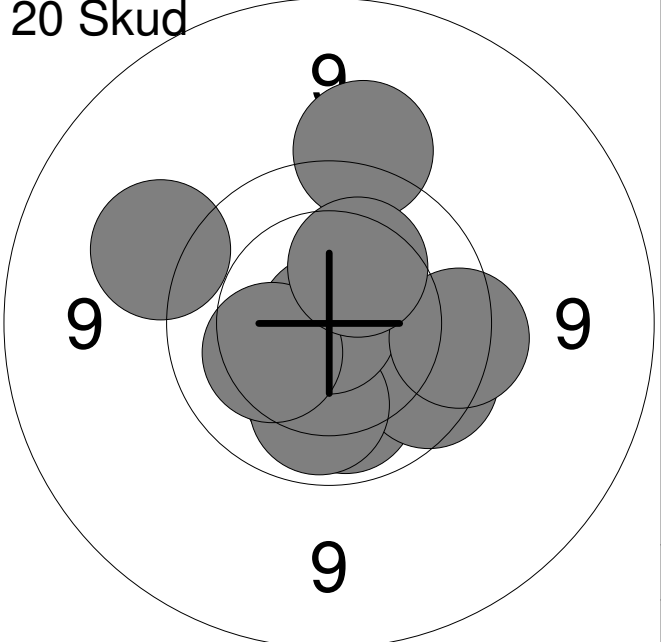
<p>20 Skud</p> 	<table style="width:100%; border-collapse: collapse;"> <tr><td style="width:10%;">1:</td><td style="width:70%;">10.2</td><td style="width:20%; text-align: right;">↘</td></tr> <tr><td>2:</td><td>10.1</td><td style="text-align: right;">↘</td></tr> <tr><td>3:</td><td>9.8</td><td style="text-align: right;">↘</td></tr> <tr><td>4:</td><td>10.1</td><td style="text-align: right;">↓</td></tr> <tr><td>5:</td><td>9.4</td><td style="text-align: right;">↗</td></tr> <tr><td>6:</td><td>9.4</td><td style="text-align: right;">↑</td></tr> <tr><td>7:</td><td>10.9x</td><td style="text-align: right;">←</td></tr> <tr><td>8:</td><td>9.7</td><td style="text-align: right;">→</td></tr> <tr><td>9:</td><td>10.3</td><td style="text-align: right;">←</td></tr> <tr><td>10:</td><td>10.3</td><td style="text-align: right;">↗</td></tr> </table>	1:	10.2	↘	2:	10.1	↘	3:	9.8	↘	4:	10.1	↓	5:	9.4	↗	6:	9.4	↑	7:	10.9x	←	8:	9.7	→	9:	10.3	←	10:	10.3	↗
1:	10.2	↘																													
2:	10.1	↘																													
3:	9.8	↘																													
4:	10.1	↓																													
5:	9.4	↗																													
6:	9.4	↑																													
7:	10.9x	←																													
8:	9.7	→																													
9:	10.3	←																													
10:	10.3	↗																													
<table style="width:100%; border-collapse: collapse;"> <tr> <td style="width:10%;">Serie</td> <td style="width:70%;"></td> <td style="width:20%; text-align: right;">96.0</td> </tr> <tr> <td>Total</td> <td></td> <td style="text-align: right;">96.0</td> </tr> </table>		Serie		96.0	Total		96.0																								
Serie		96.0																													
Total		96.0																													

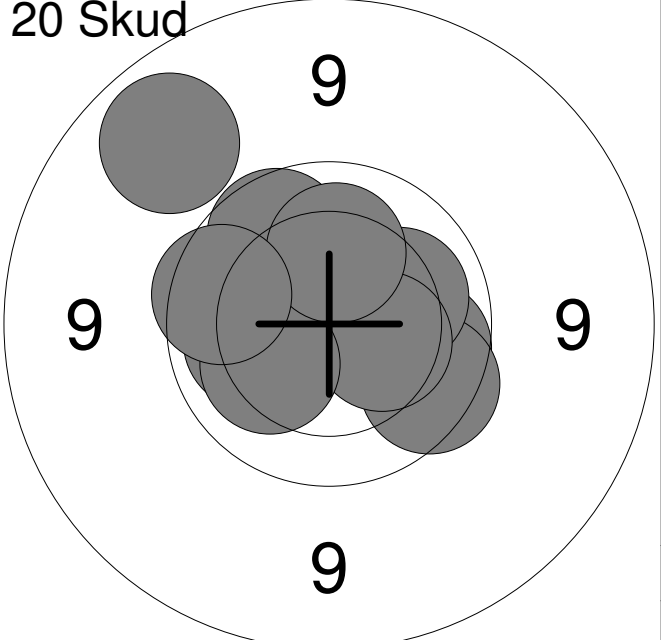
<p>20 Skud</p> 	<table style="width:100%; border-collapse: collapse;"> <tr><td style="width:10%;">11:</td><td style="width:70%;">9.9</td><td style="width:20%; text-align: right;">→</td></tr> <tr><td>12:</td><td>9.8</td><td style="text-align: right;">↘</td></tr> <tr><td>13:</td><td>10.2</td><td style="text-align: right;">→</td></tr> <tr><td>14:</td><td>9.0</td><td style="text-align: right;">↗</td></tr> <tr><td>15:</td><td>10.1</td><td style="text-align: right;">←</td></tr> <tr><td>16:</td><td>10.3</td><td style="text-align: right;">↘</td></tr> <tr><td>17:</td><td>9.9</td><td style="text-align: right;">↗</td></tr> <tr><td>18:</td><td>10.2</td><td style="text-align: right;">←</td></tr> <tr><td>19:</td><td>10.2</td><td style="text-align: right;">↑</td></tr> <tr><td>20:</td><td>9.8</td><td style="text-align: right;">←</td></tr> </table>	11:	9.9	→	12:	9.8	↘	13:	10.2	→	14:	9.0	↗	15:	10.1	←	16:	10.3	↘	17:	9.9	↗	18:	10.2	←	19:	10.2	↑	20:	9.8	←
11:	9.9	→																													
12:	9.8	↘																													
13:	10.2	→																													
14:	9.0	↗																													
15:	10.1	←																													
16:	10.3	↘																													
17:	9.9	↗																													
18:	10.2	←																													
19:	10.2	↑																													
20:	9.8	←																													
<table style="width:100%; border-collapse: collapse;"> <tr> <td style="width:10%;">Serie</td> <td style="width:70%;"></td> <td style="width:20%; text-align: right;">95.0</td> </tr> <tr> <td>Total</td> <td></td> <td style="text-align: right;">191.0</td> </tr> </table>		Serie		95.0	Total		191.0																								
Serie		95.0																													
Total		191.0																													

Hold 79	Skive 10	Kaj Mørk
-------------------	--------------------	-----------------

15m	Vester Hassing Skf.	MJ1
-----	---------------------	-----

24.10.2013	15 meter riffelstævne 2013	Aalborg Skyttekreds
------------	----------------------------	---------------------

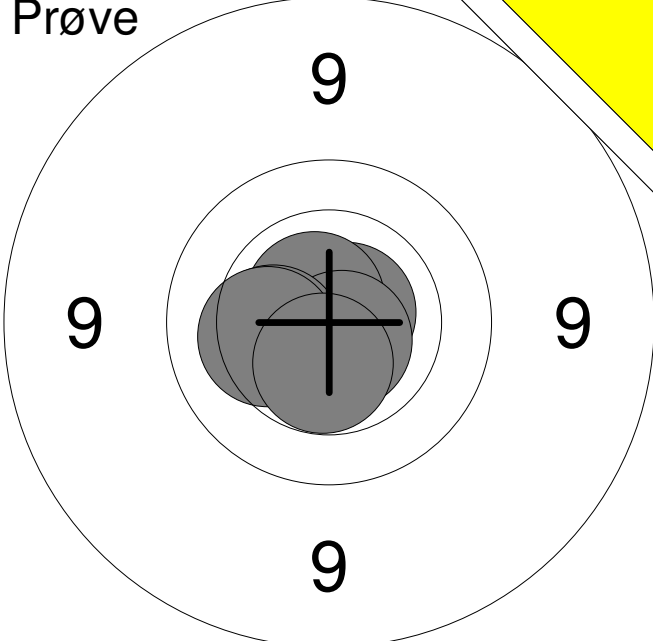
Prøve 	1: 10.7x → 2: 10.7x ↗ 3: 10.7x ↓ 4: 10.3 ← 5: 10.3 ← 6: 10.5x ↓
	Serie 60.0 Total 0.0

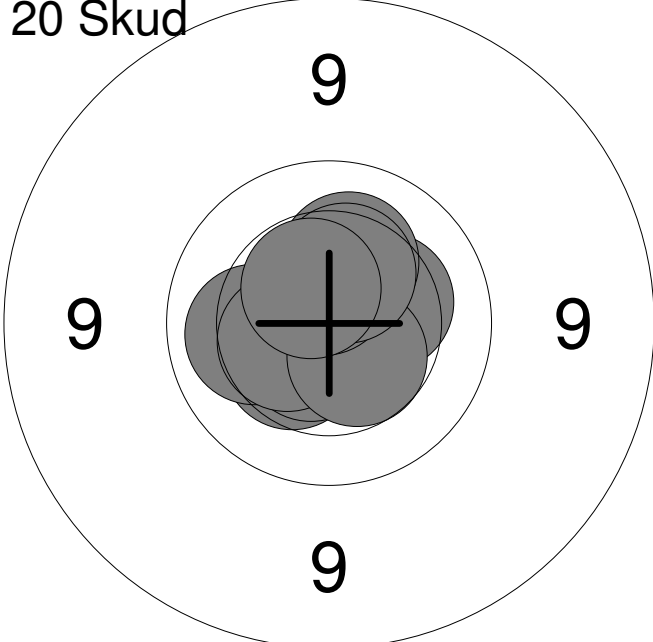
20 Skud 	1: 10.3 → 2: 10.4 ↙ 3: 10.3 ↑ 4: 10.1 ← 5: 10.6x ↙ 6: 10.5 ← 7: 10.5 ↓ 8: 10.5x ↑ 9: 10.4 ↑ 10: 10.5x ↑
	Serie 100.0 Total 100.0

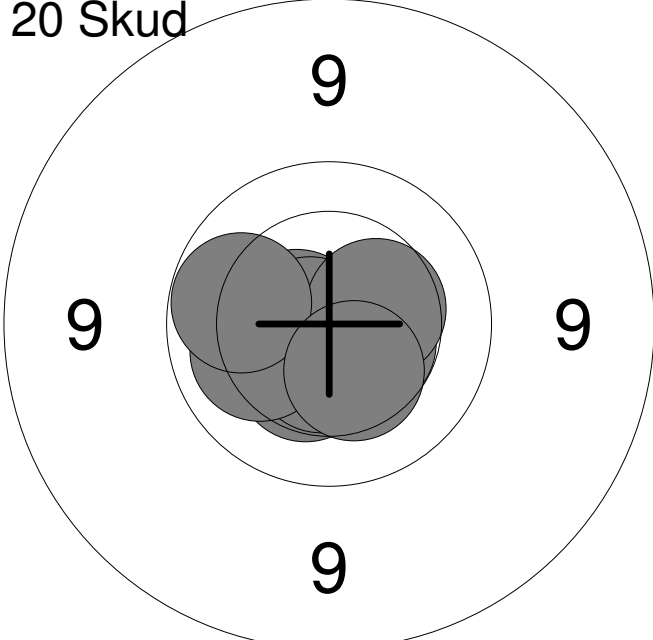
20 Skud 	11: 10.8x ↙ 12: 10.6x ← 13: 10.4 ↙ 14: 10.5x ↓ 15: 10.5x → 16: 10.7x ← 17: 10.2 ↙ 18: 10.4 → 19: 10.0 ← 20: 10.4 ↓
	Serie 100.0 Total 200.0

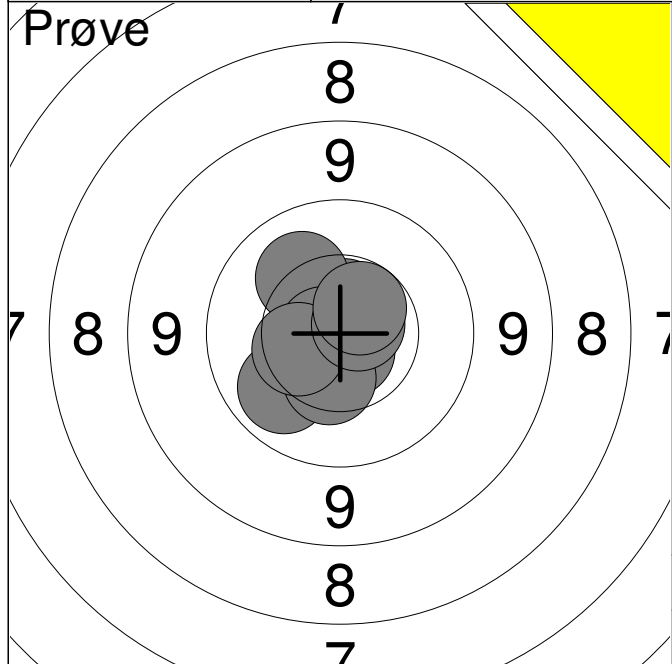

1:	10.7x	←
2:	10.6x	↑
3:	10.1	↙
4:	10.2	↗
5:	10.8x	←
6:	10.7x	↓
7:	10.4	↓
8:	10.4	←
9:	10.7x	↗
10:	10.6	↗
Serie		100.0
Total		0.0

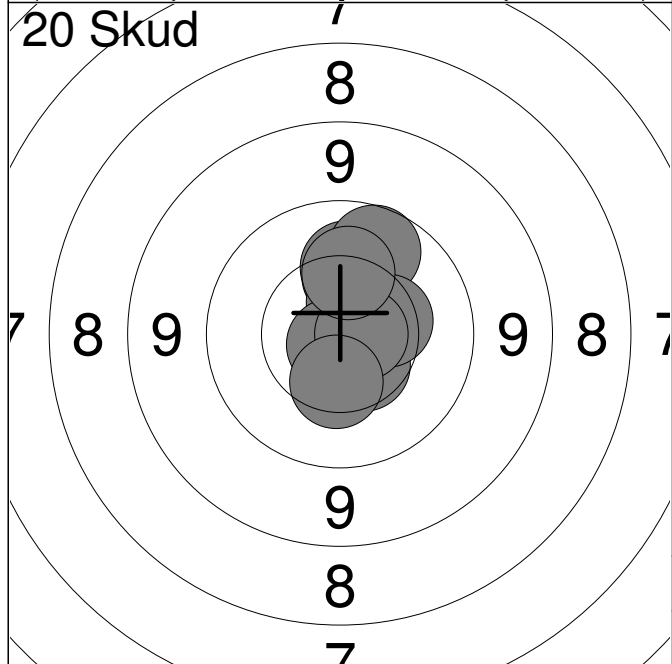

1:	10.5	↘
2:	10.3	↑
3:	10.6	↗
4:	10.8x	↙
5:	10.2	↑
6:	9.9	↗
7:	10.4	→
8:	10.7x	→
9:	10.4	↓
10:	10.2	↑
Serie		99.0
Total		99.0

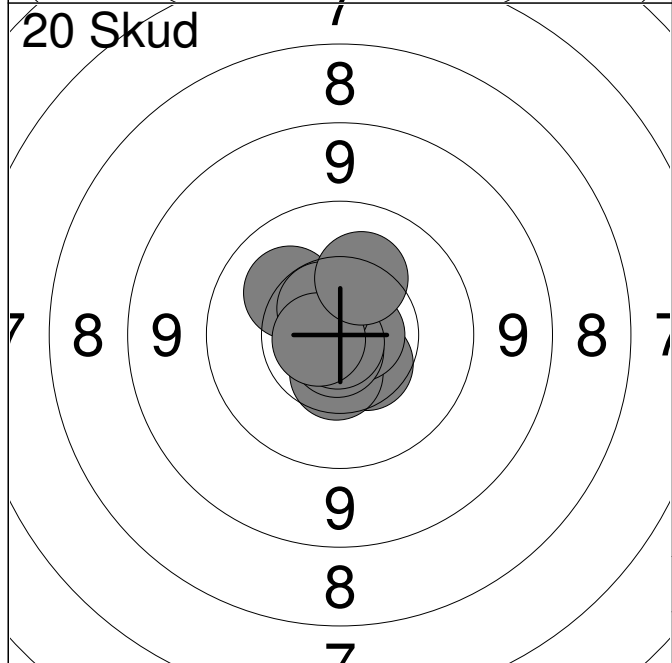

11:	10.7x	↓
12:	10.5	↘
13:	10.5	↓
14:	10.7x	→
15:	10.8x	↘
16:	10.2	↗
17:	10.9x	↘
18:	10.6x	↗
19:	10.7x	←
20:	10.3	↑
Serie		100.0
Total		199.0

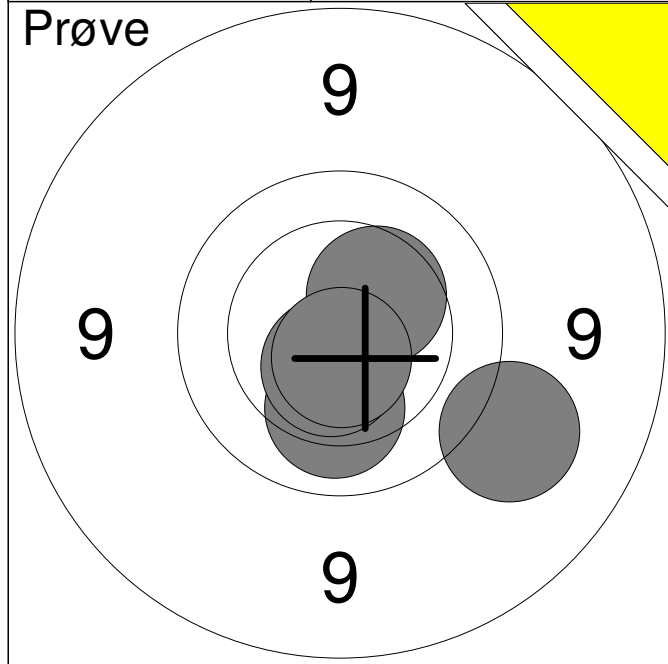

1:	9.3	→
2:	10.4	↗
3:	10.1	↓
4:	10.6x	↓
5:	10.7x	↓
Serie		49.0
Total		0.0

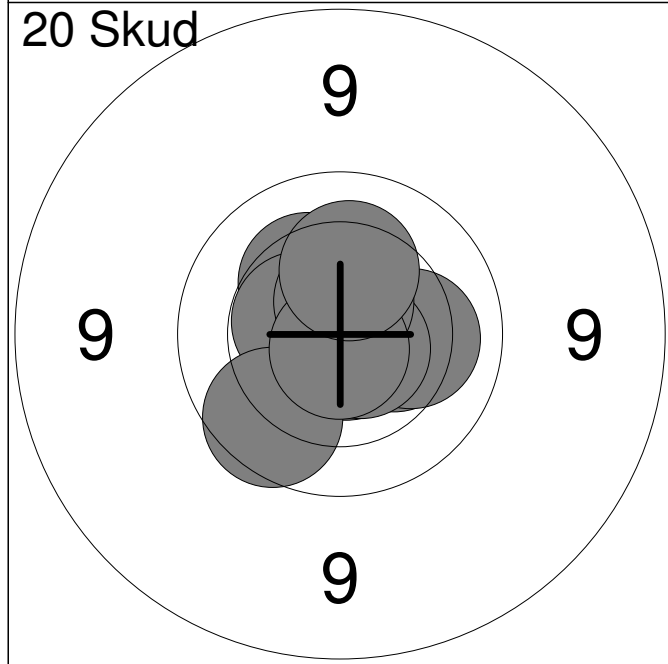

1:	10.4	→
2:	10.8x	↓
3:	10.3	↗
4:	10.5x	↖
5:	10.2	→
6:	9.9	↙
7:	10.7x	↘
8:	10.6x	↑
9:	10.8x	↓
10:	10.3	↑
Serie		99.0
Total		99.0

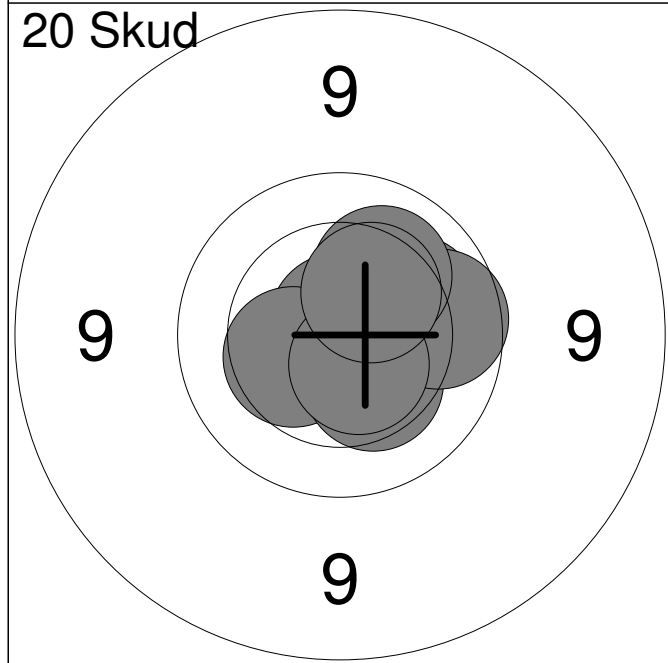

11:	10.5	→
12:	10.8x	↑
13:	10.4	↖
14:	10.1	→
15:	10.5	↗
16:	10.3	↘
17:	9.9	→
18:	10.6x	↘
19:	10.2	↗
20:	10.4	↗
Serie		99.0
Total		198.0

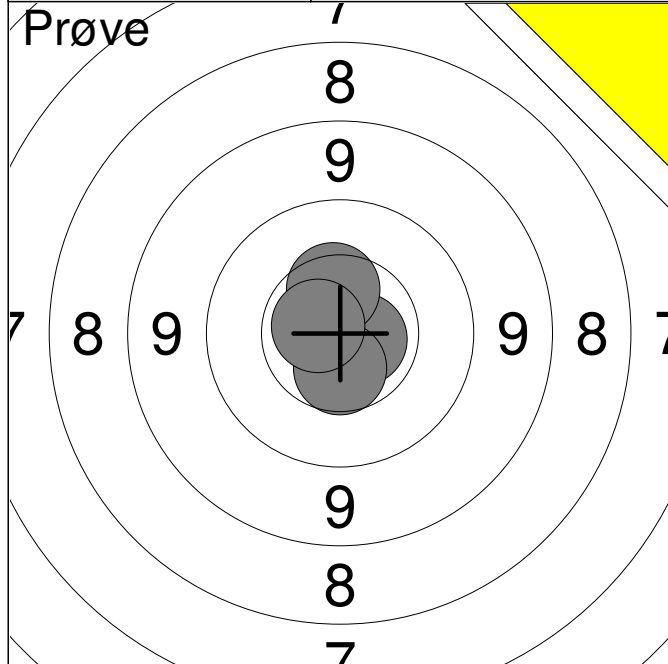

1:	10.7x	→
2:	10.5	↓
3:	10.4	↑
4:	10.7x	↖
Serie	40.0	
Total	0.0	

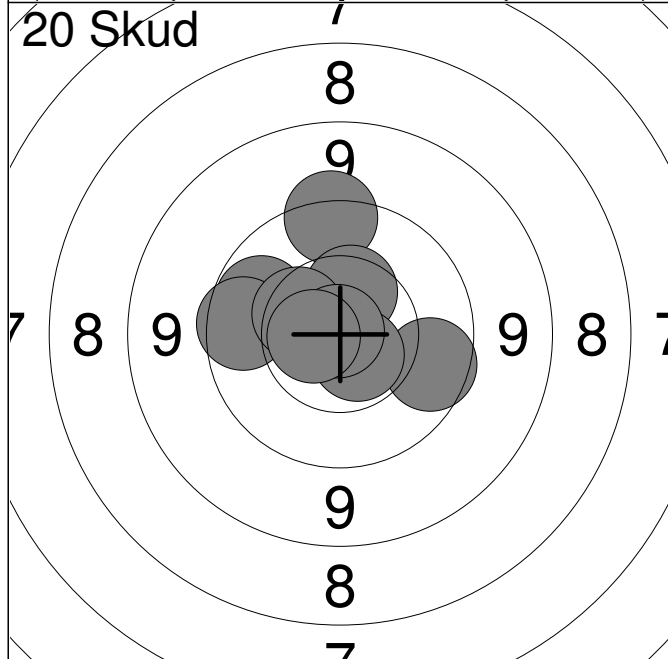

1:	9.6	↑
2:	10.0	↖
3:	9.8	←
4:	10.6x	↗
5:	10.4	↑
6:	9.8	↘
7:	10.4	↗
8:	10.6x	↘
9:	10.9x	↗
10:	10.6x	←
Serie	97.0	
Total	97.0	

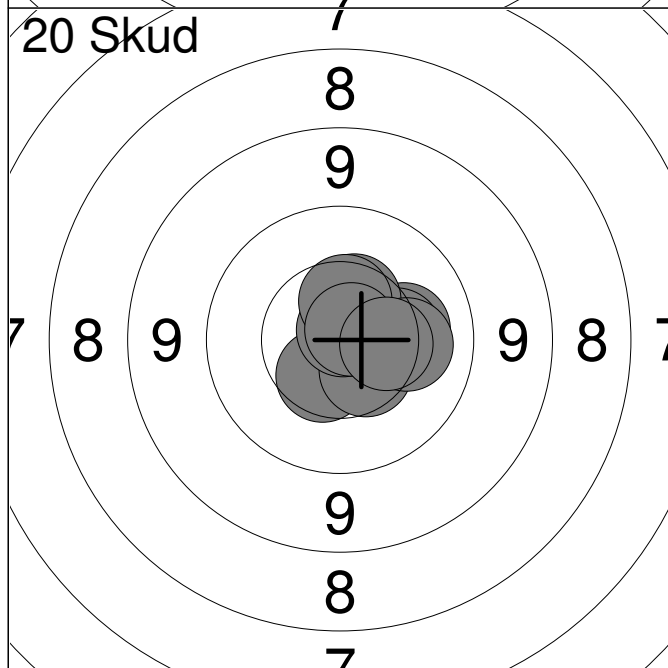

11:	10.2	→
12:	10.5	↘
13:	10.3	→
14:	10.5	↘
15:	10.8x	↑
16:	10.5	↑
17:	10.2	→
18:	10.5	↑
19:	10.8x	↗
20:	10.4	→
Serie	100.0	
Total	197.0	

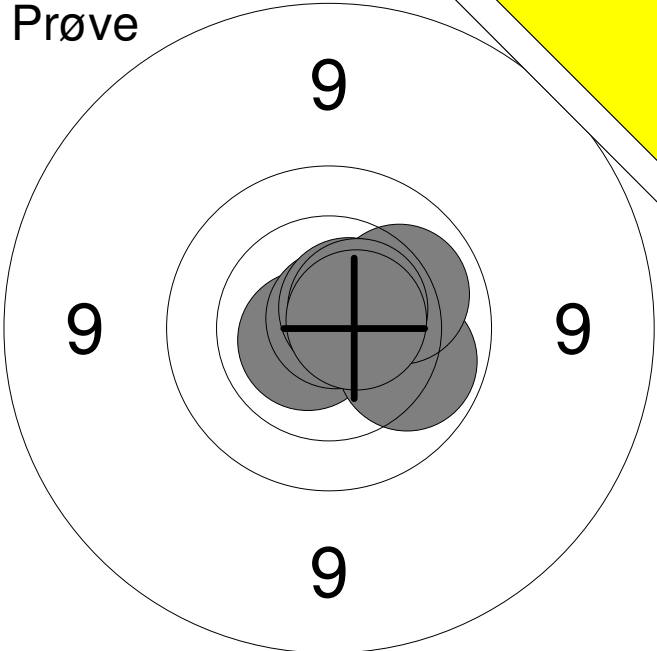
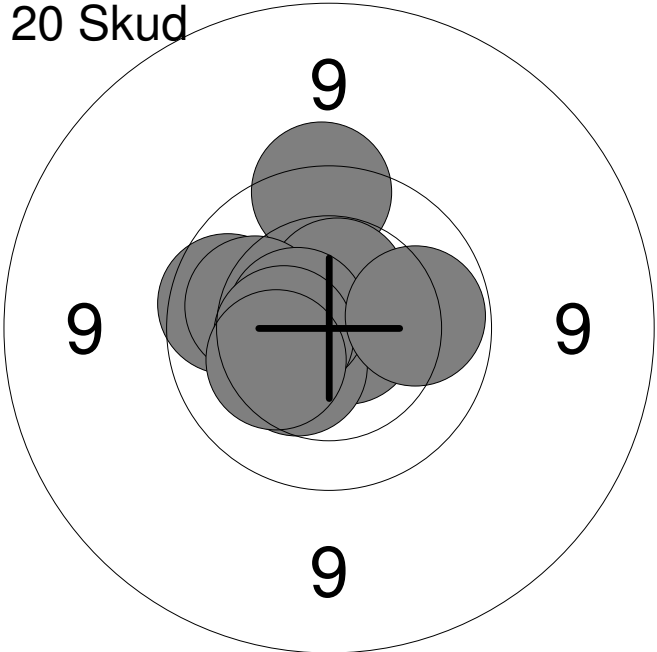
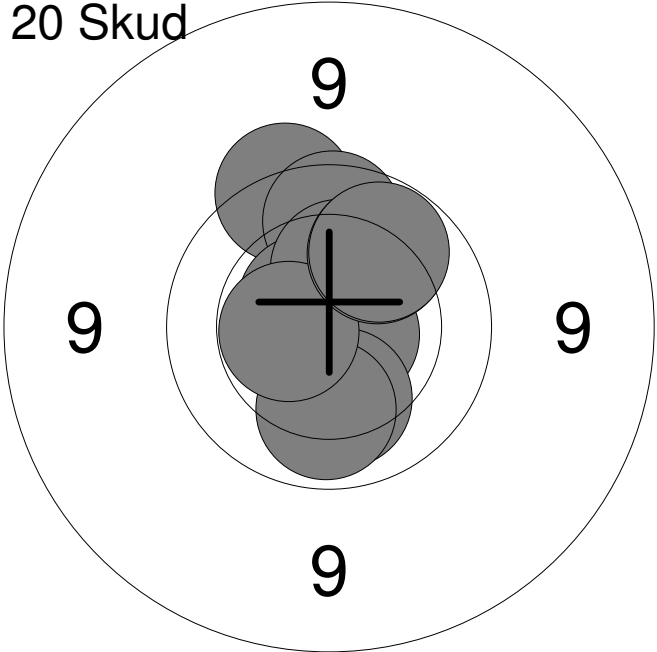
Hold	Skive	Jacob Schultz	
80	2	15m	Vester Hassing Skf. MB1
24.10.2013	15 meter riffelstævne 2013	Aalborg Skyttekreds	
Prøve 	1:	10.7x	↙
	2:	10.8x	↗
	3:	10.0	→
	4:	10.1	↗
	5:	10.6x	↗
	6:	10.6x	↗
	7:	10.6x	→
	Serie	70.0	
	Total	0.0	
20 Skud 	1:	10.8x	→
	2:	9.7	↑
	3:	10.5x	↑
	4:	9.9	↙
	5:	10.1	↙
	6:	10.4	↙
	7:	10.6x	↙
	8:	10.5	↙
	9:	10.3	↙
	10:	10.0	→
	Serie	98.0	
	Total	98.0	
20 Skud 	11:	9.7	↑
	12:	9.9	↑
	13:	10.6x	↗
	14:	10.3	↑
	15:	10.7x	→
	16:	10.2	↓
	17:	10.1	↓
	18:	10.5x	↙
	19:	10.0	↗
	20:	10.0	↗
	Serie	98.0	
	Total	196.0	

Hold 80	Skive 3	Nikolaj Lund Nymann	
-------------------	-------------------	----------------------------	--

15m	Vester Hassing Skf.	MJ1	
-----	---------------------	-----	--

24.10.2013	15 meter riffelstævne 2013	Aalborg Skyttekreds	
------------	----------------------------	---------------------	--

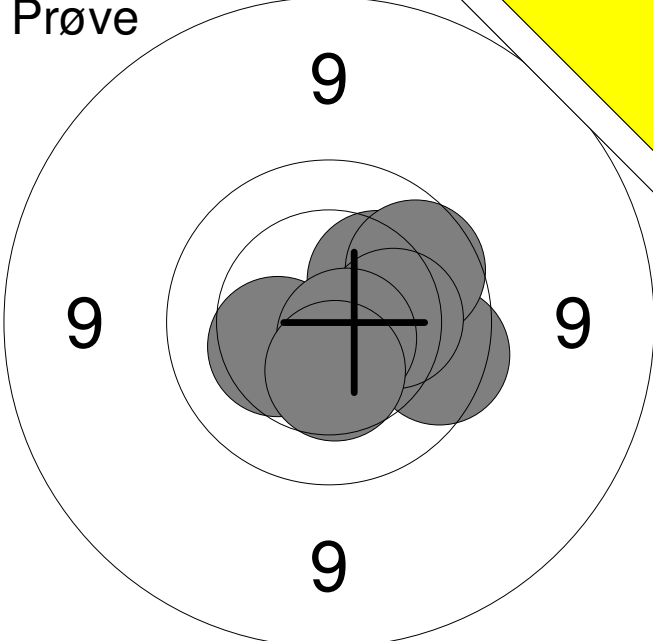
Prøve 	1: 9.8 →
	2: 10.3 ↗
	3: 9.9 ↗
	4: 10.3 →
	5: 10.3 ←
	6: 10.7x ↘
	7: 10.4 ↓
Serie	68.0
Total	0.0

20 Skud 	1: 10.1 ↗
	2: 10.8x ↓
	3: 10.1 ↙
	4: 10.6x ↗
	5: 9.9 →
	6: 10.1 ↓
	7: 9.8 ↓
	8: 10.4 ↙
	9: 10.4 ↓
	10: 10.4 →
Serie	98.0
Total	98.0

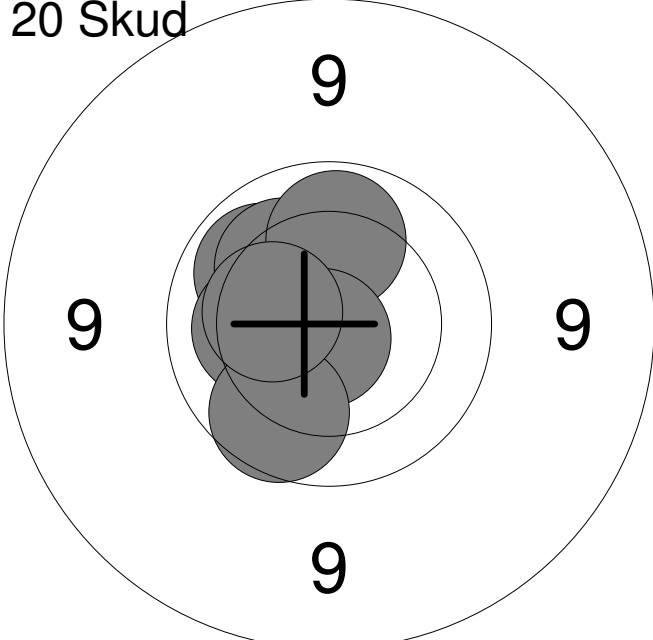
20 Skud 	11: 10.4 ↙
	12: 10.4 ←
	13: 10.1 ↗
	14: 10.1 ↗
	15: 10.2 ←
	16: 10.2 ↗
	17: 10.1 ↑
	18: 10.8x ↙
	19: 9.9 ↙
	20: 10.3 ←
Serie	99.0
Total	197.0

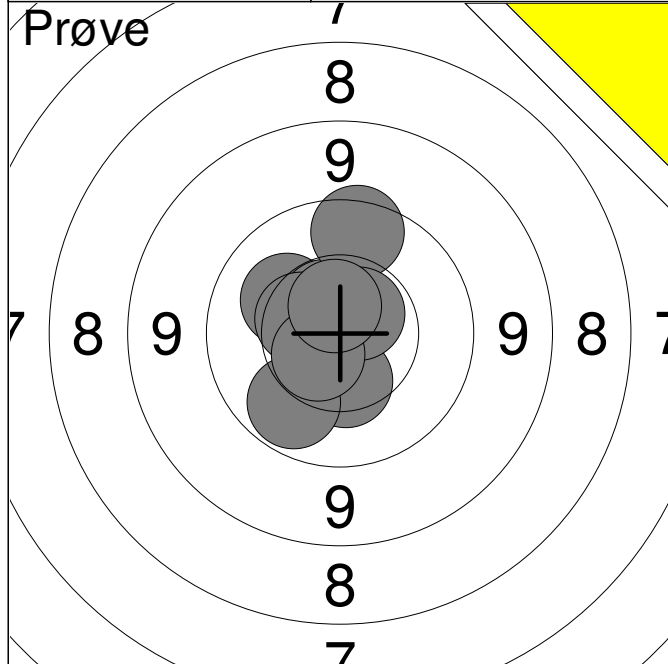

1:	10.2	↗
2:	10.6x	↗
3:	10.4	↘
4:	10.5	↖
5:	10.0	↘
6:	9.7	↗
7:	10.6x	↗
8:	10.6x	↖
9:	10.6x	↗
Serie	89.0	
Total	0.0	

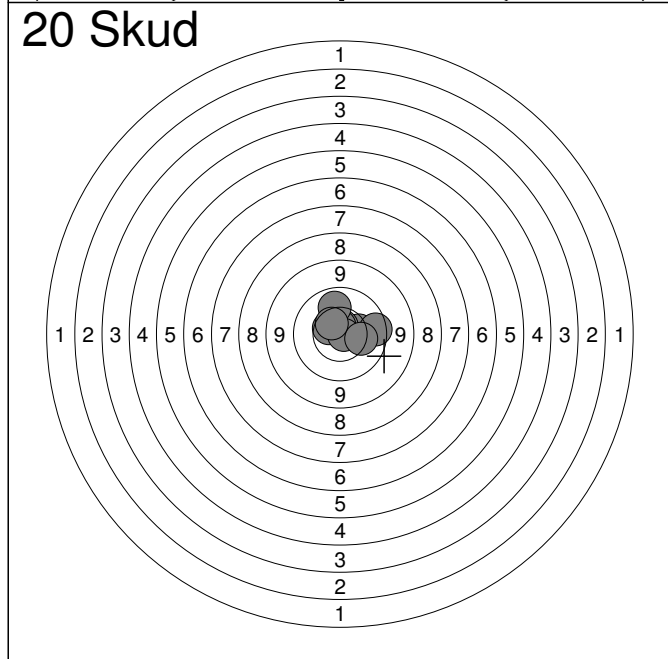

1:	10.3	→
2:	10.7x	↑
3:	9.7	→
4:	10.5	↖
5:	10.7x	↑
6:	10.8x	→
7:	10.2	→
8:	10.1	↑
9:	0.0	↘
10:	10.5	↗
Serie	89.0	
Total	89.0	

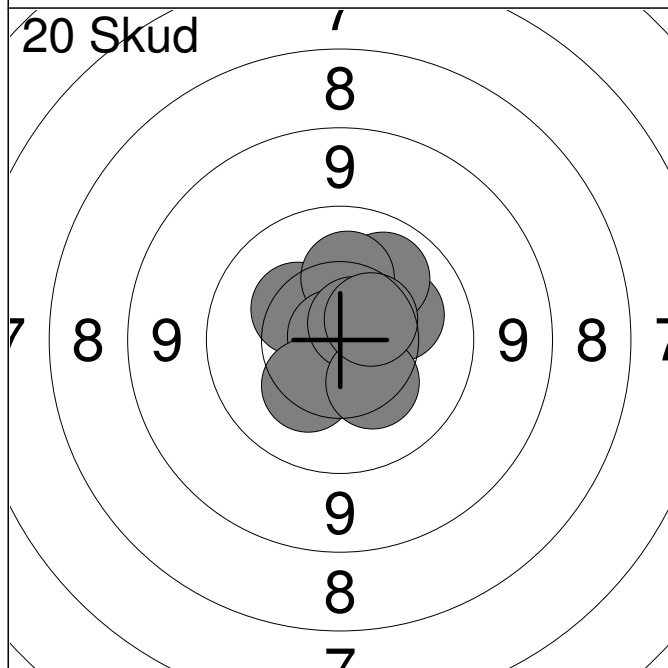

11:	10.5	↗
12:	10.2	→
13:	10.3	↖
14:	10.1	↗
15:	10.2	↑
16:	10.9x	↖
17:	10.3	↘
18:	10.7x	↗
19:	10.3	↘
20:	10.5	↗
Serie	100.0	
Total	189.0	

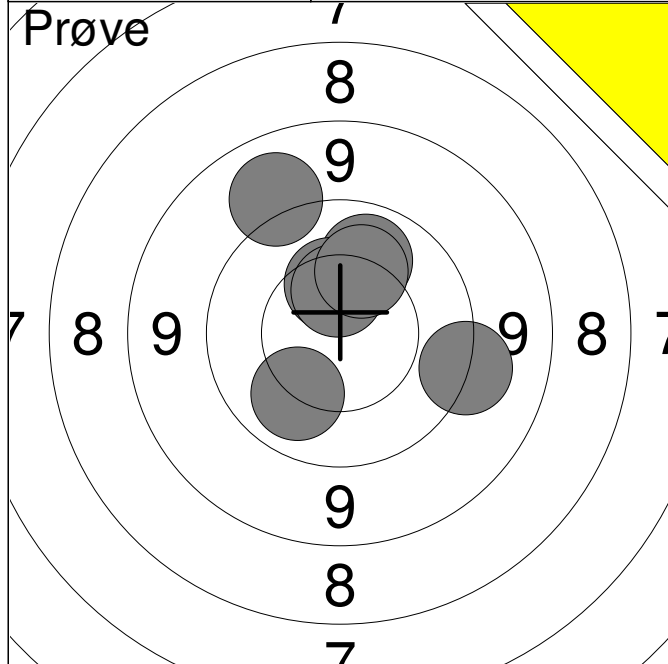

1:	9.4	→
2:	9.2	↗
3:	10.1	↗
4:	10.4	↑
5:	10.4	↑
6:	10.1	↘
7:	10.2	↗
Serie		68.0
Total		0.0

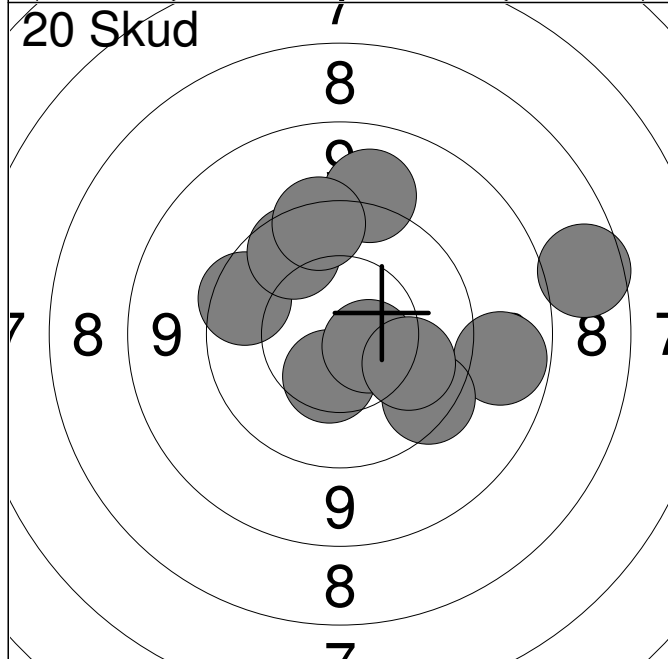

1:	9.2	↑
2:	9.8	↖
3:	9.9	↗
4:	9.6	↑
5:	9.0	→
6:	10.4	↘
7:	10.6x	→
8:	9.7	↘
9:	7.8	→
10:	10.1	→
Serie		91.0
Total		91.0

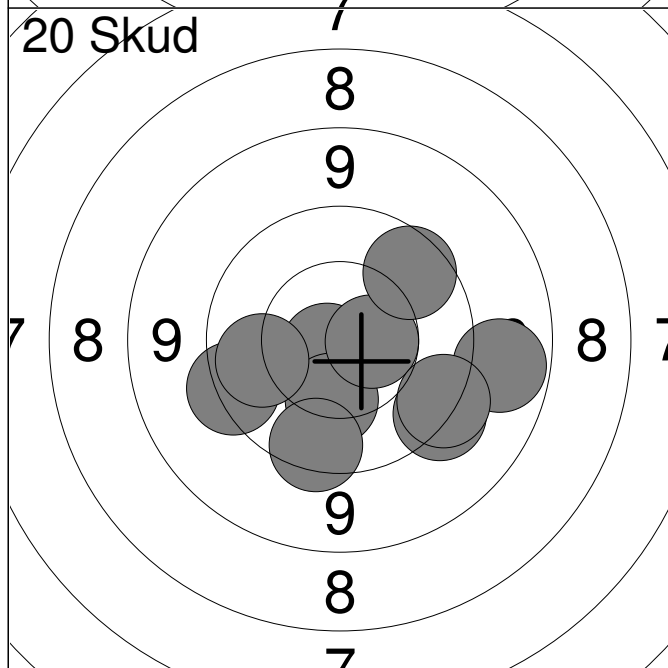

11:	10.8x	↖
12:	9.6	↖
13:	10.3	↘
14:	9.7	↘
15:	9.5	↘
16:	10.0	↖
17:	9.0	→
18:	10.6	→
19:	9.8	↗
20:	9.5	↘
Serie		94.0
Total		185.0

Hold 80	Skive 6	Rasmus M. Larsen	
-------------------	-------------------	-------------------------	--

15m	Vilsted Skf.	MÅ1	
-----	--------------	-----	--

24.10.2013	15 meter riffelstævne 2013	Aalborg Skyttekreds	
------------	----------------------------	---------------------	--

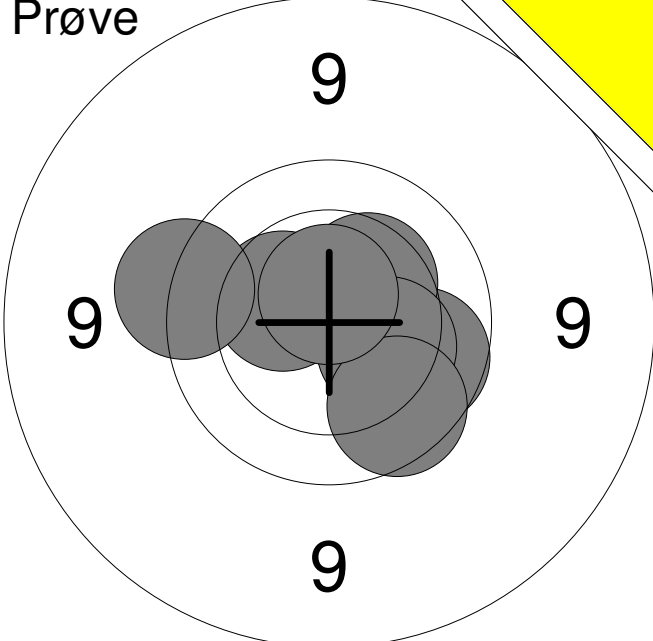
Prøve 	1: 9.9 → 2: 10.4 ↗ 3: 10.4 ↗ 4: 10.3 → 5: 9.6 ← 6: 9.9 ↘ 7: 10.6x ↑
	Serie 67.0 Total 0.0

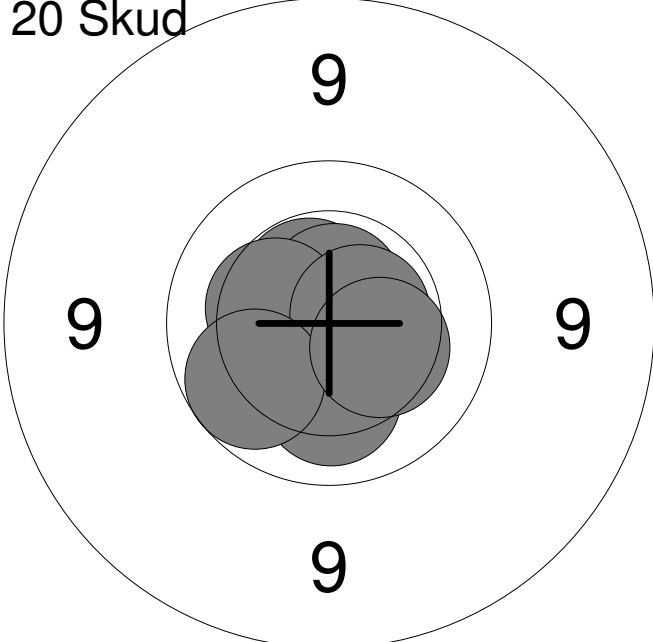
20 Skud 	1: 10.8x ↓ 2: 10.5 ↘ 3: 10.5x ↗ 4: 10.6x ↑ 5: 10.7x ↓ 6: 10.2 ↓ 7: 10.4 ← 8: 10.6x → 9: 9.9 ↙ 10: 10.3 →
	Serie 99.0 Total 99.0

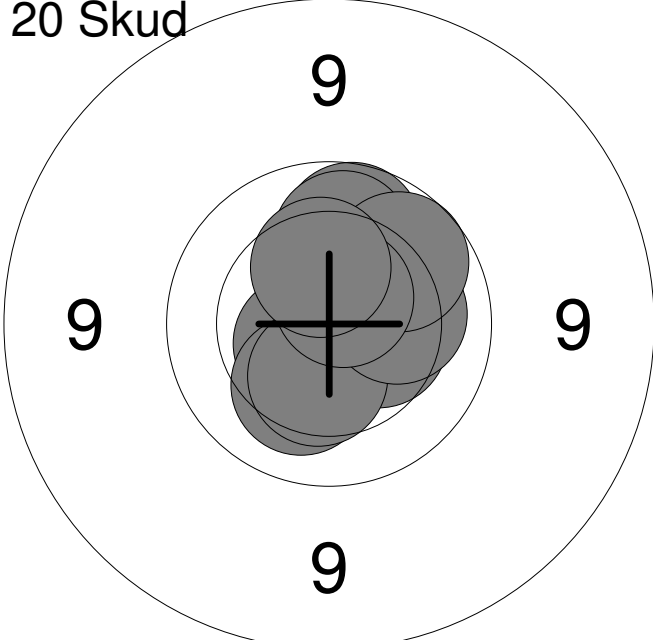
20 Skud 	11: 9.9 ↑ 12: 10.0 ↑ 13: 10.6x ↙ 14: 10.4 → 15: 10.2 ↓ 16: 10.4 ↓ 17: 10.2 → 18: 9.9 ↗ 19: 10.6x ↗ 20: 10.3 ↑
	Serie 98.0 Total 197.0

Hold 80	Skive 7	Mathias Levinsen	
-------------------	-------------------	-------------------------	--

15m	Vilsted Skf.	BK3	
-----	--------------	-----	--

24.10.2013	15 meter riffelstævne 2013	Aalborg Skyttekreds	
------------	----------------------------	---------------------	--

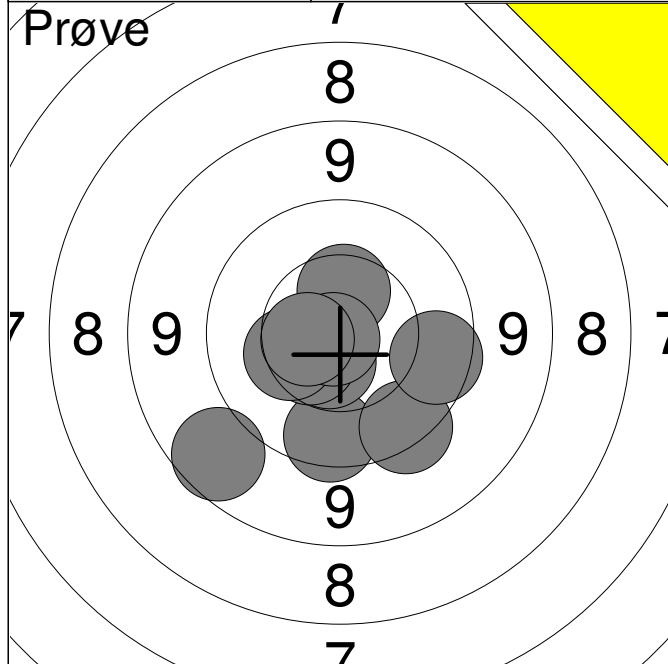

1:	8.9	↙
2:	9.7	↓
3:	9.6	↘
4:	10.6x	↓
5:	10.5	↙
6:	10.3	←
7:	10.5	↑
8:	9.8	→
9:	10.8x	↙
10:	10.6	←
Serie	95.0	
Total	0.0	

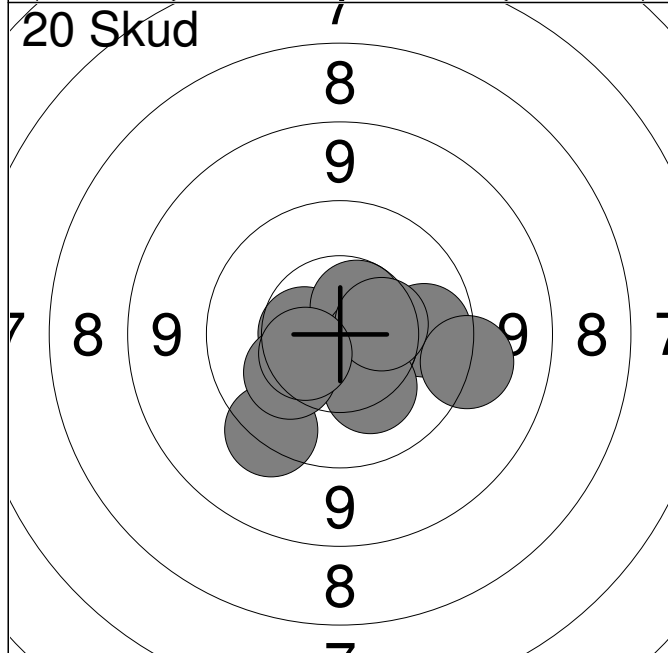

1:	10.5	←
2:	10.0	→
3:	10.6	↗
4:	10.6	→
5:	9.4	→
6:	10.2	↓
7:	10.5	→
8:	9.6	↙
9:	10.2	↙
10:	10.5	↙
Serie	98.0	
Total	98.0	

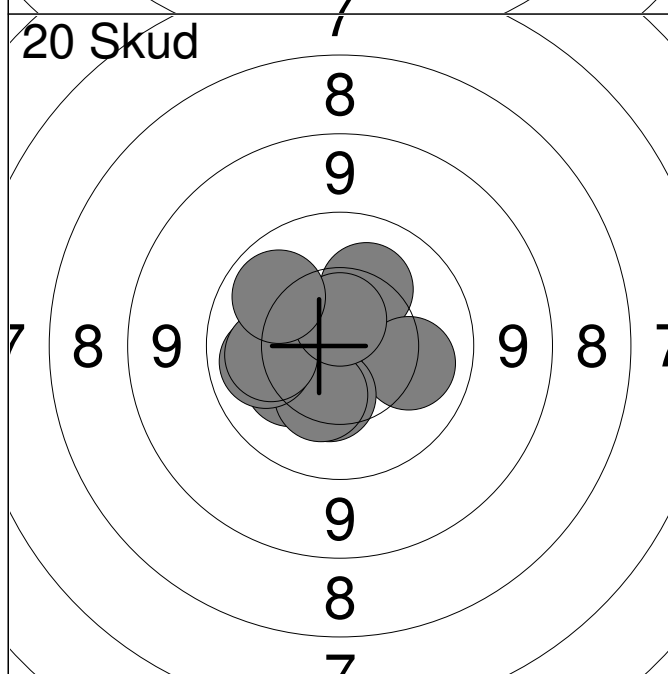

11:	10.6x	←
12:	10.2	↗
13:	10.1	→
14:	10.4	↓
15:	10.3	↙
16:	10.3	↓
17:	10.1	←
18:	10.1	←
19:	10.6x	↑
20:	10.0	↙
Serie	100.0	
Total	198.0	

Hold 80	Skive 8	Magnus Dahl	
-------------------	-------------------	--------------------	--

15m	Vester Hassing Skf.	MJ1	
-----	---------------------	-----	--

24.10.2013	15 meter riffelstævne 2013	Aalborg Skyttekreds	
------------	----------------------------	---------------------	--

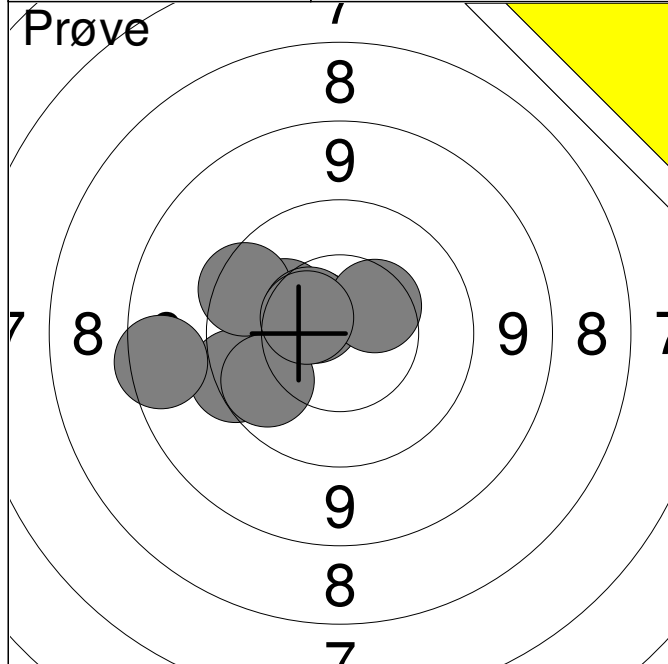

1:	9.6	←
2:	8.7	←
3:	10.2	↗
4:	9.7	↗
5:	10.6x	↗
6:	10.5	↗
7:	10.0	←
8:	10.4	↗
9:	10.5	↗

Serie	86.0
Total	0.0

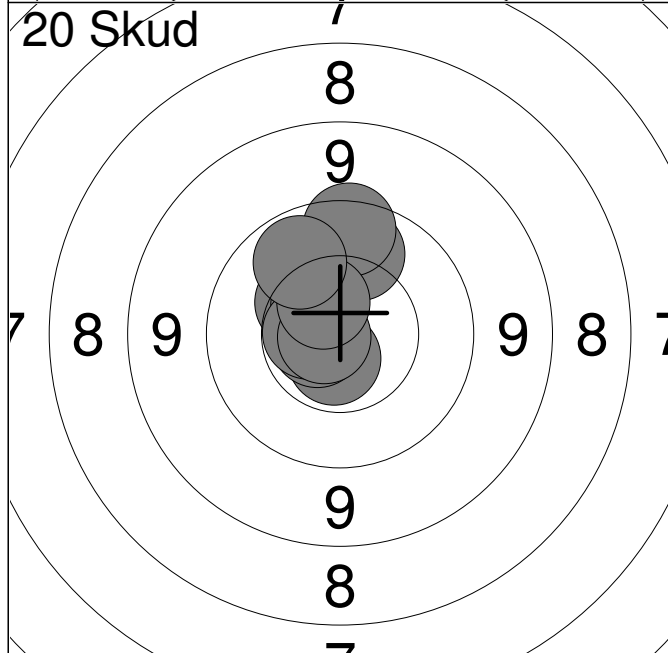

1:	10.7x	↓
2:	10.4	↗
3:	10.7x	←
4:	10.5	↗
5:	10.0	↑
6:	9.7	↑
7:	10.6x	←
8:	10.8x	←
9:	10.5	↗
10:	10.0	↗

Serie	99.0
Total	99.0

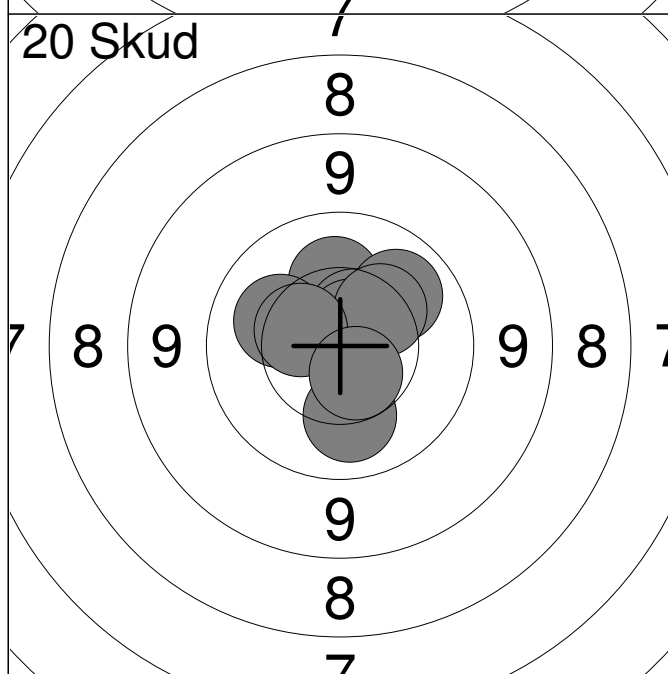

11:	10.2	↑
12:	10.2	←
13:	10.8x	↗
14:	10.6	↗
15:	10.7x	↗
16:	10.1	↗
17:	10.3	↗
18:	10.1	↓
19:	10.5	↗
20:	10.6	↓

Serie	100.0
Total	199.0

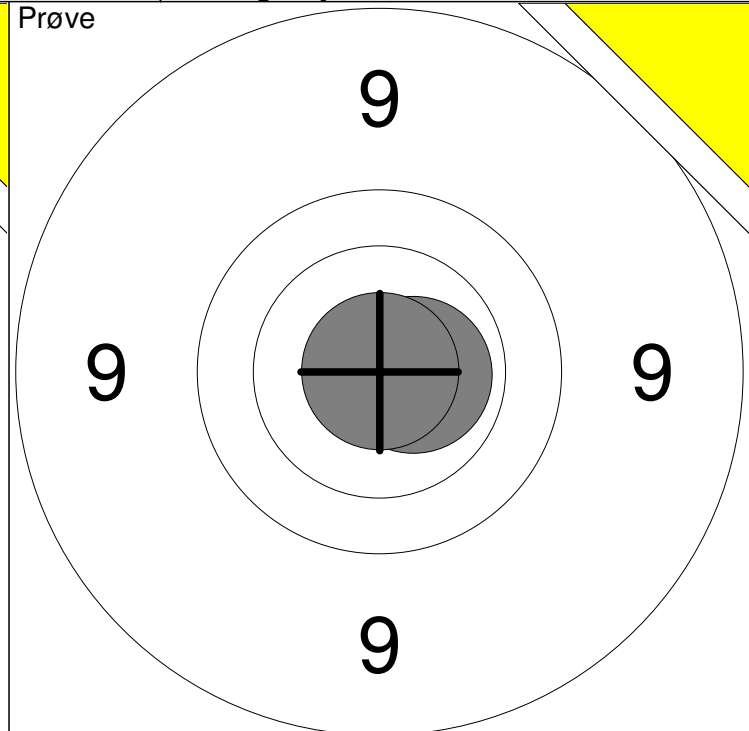
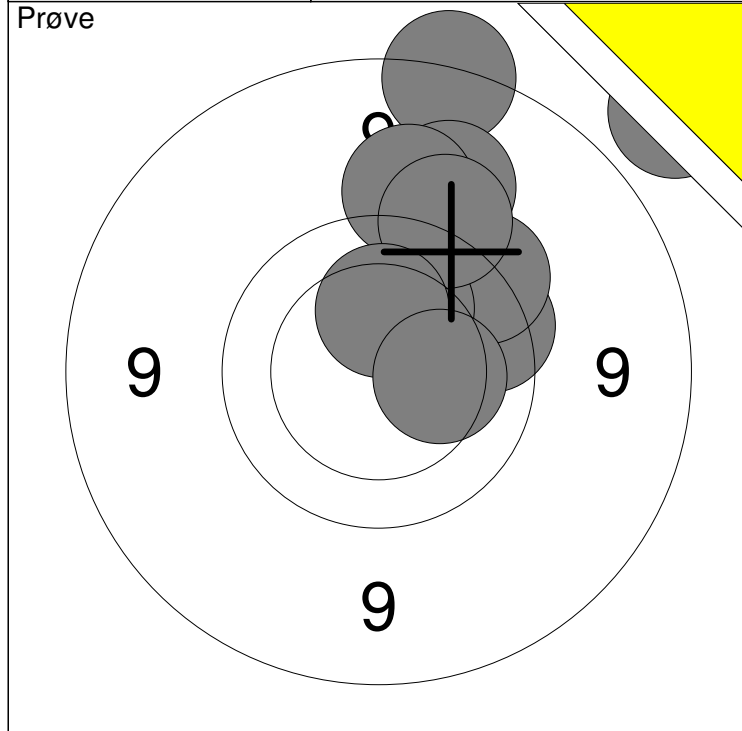

1: 8.3 ↗	6: 9.6 ↗	Serie	91
2: 8.7 ↑	7: 10.2 ↑		
3: 9.3 ↑	8: 9.5 ↑	Total	0
4: 9.3 ↑	9: 10.3 ↑		
5: 9.8 ↗	10: 10.3 →		

11: 10.6x →	Serie	20
12: 10.9x ↗		
Total		0

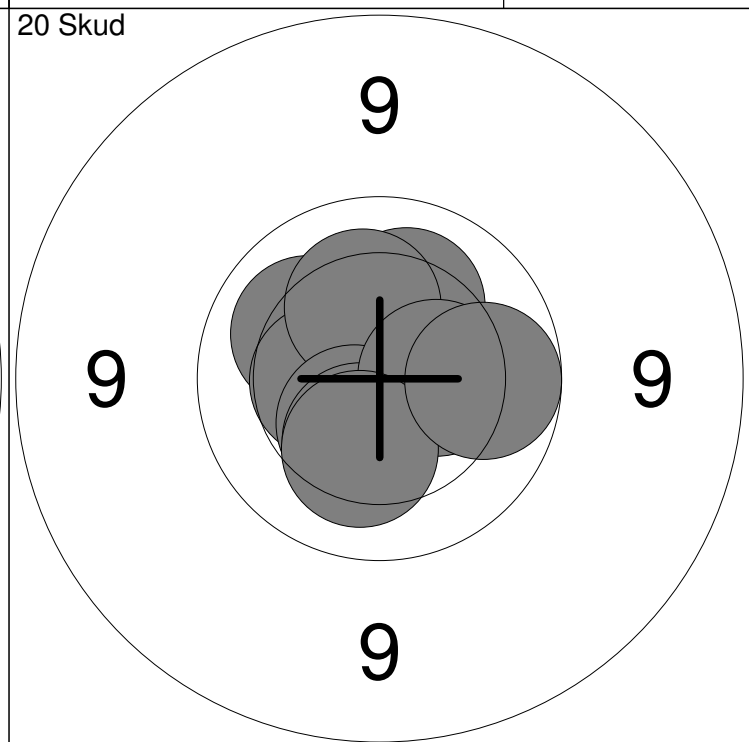
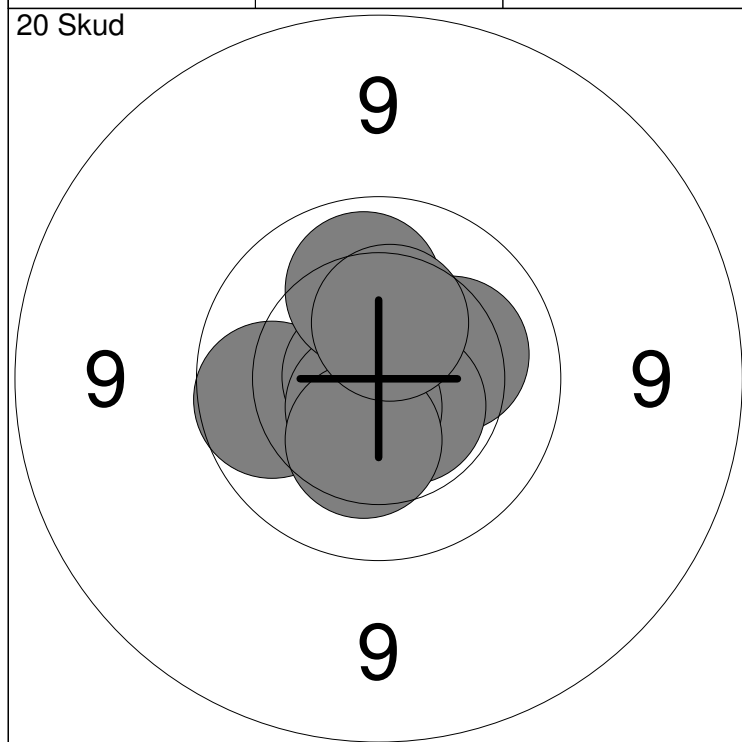

1: 10.2 →	6: 10.8x ←	Serie	99
2: 9.9 ←	7: 10.6x ↓		
3: 10.6x ↓	8: 10.3 ↓	Total	99
4: 10.7x ↓	9: 10.1 ↑		
5: 10.6x ↓	10: 10.4 ↑		

11: 10.1 ↖	16: 10.5 ↓	Serie	99
12: 10.8x ↘	17: 10.3 ↓		
13: 10.4 ←	18: 10.4 →	Total	198
14: 10.2 ↑	19: 10.2 ↓		
15: 10.2 ↑	20: 9.9 →		

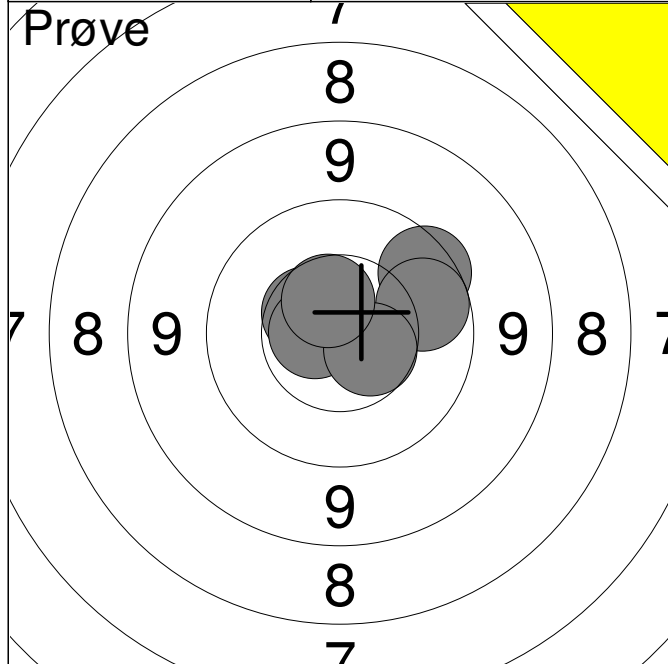

1:	10.5	↗
2:	9.7	↗
3:	10.7x	↖
4:	9.9	↗
5:	10.6	↘
6:	10.6	↗
Serie	58.0	
Total	0.0	

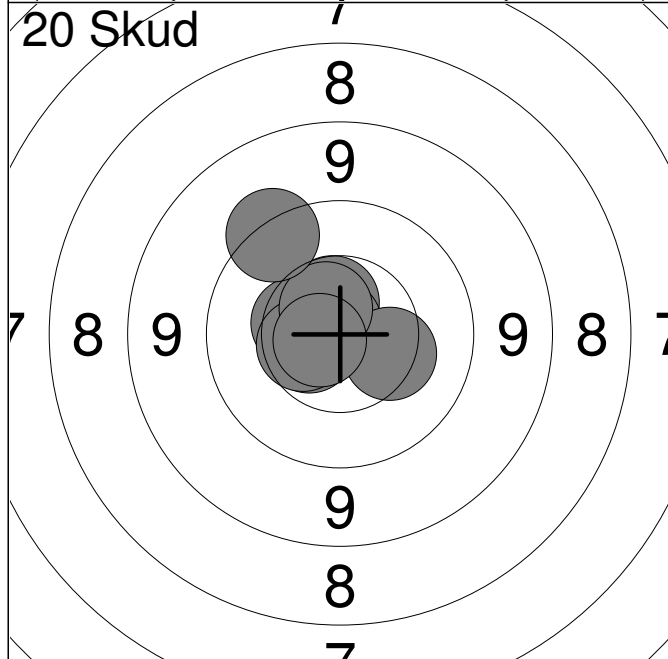

1:	10.7x	↗
2:	10.4	↖
3:	10.6	↗
4:	10.6	↖
5:	10.5	↖
6:	10.8x	↗
7:	10.3	↘
8:	10.6x	↗
9:	10.7x	↖
10:	9.5	↗
Serie	99.0	
Total	99.0	

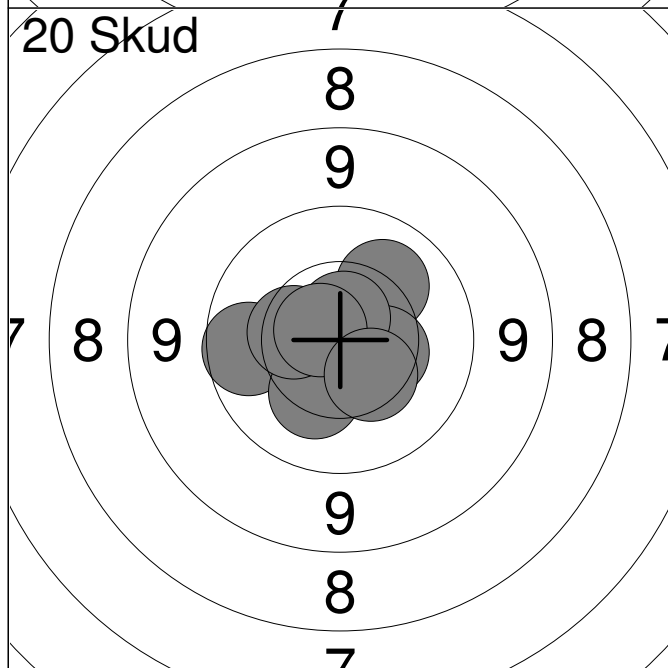

11:	10.5	↖
12:	10.7x	↗
13:	9.9	↖
14:	10.2	↗
15:	10.4	↘
16:	10.3	↘
17:	10.4	↖
18:	10.7x	↗
19:	10.7x	↗
20:	10.4	↘
Serie	99.0	
Total	198.0	

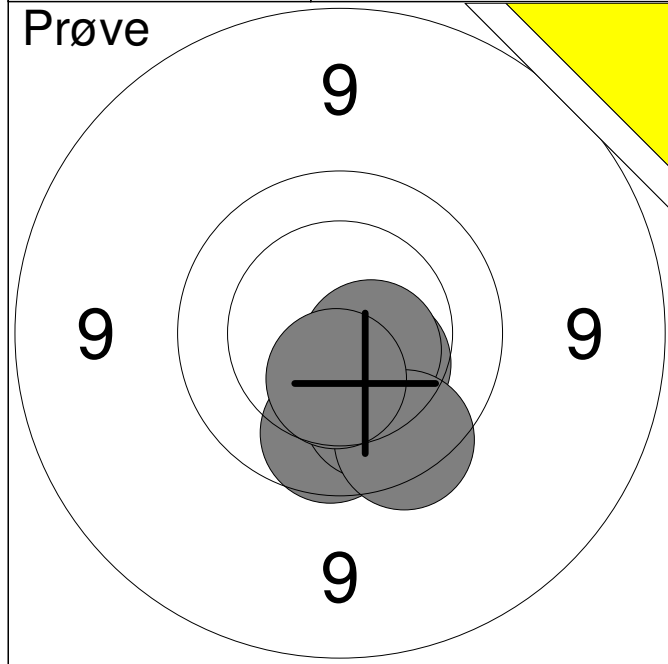

1:	9.9	↓
2:	10.1	↓
3:	10.4	↓
4:	10.6x	↓
5:	9.8	↓
6:	10.5	↓
Serie		58.0
Total		0.0

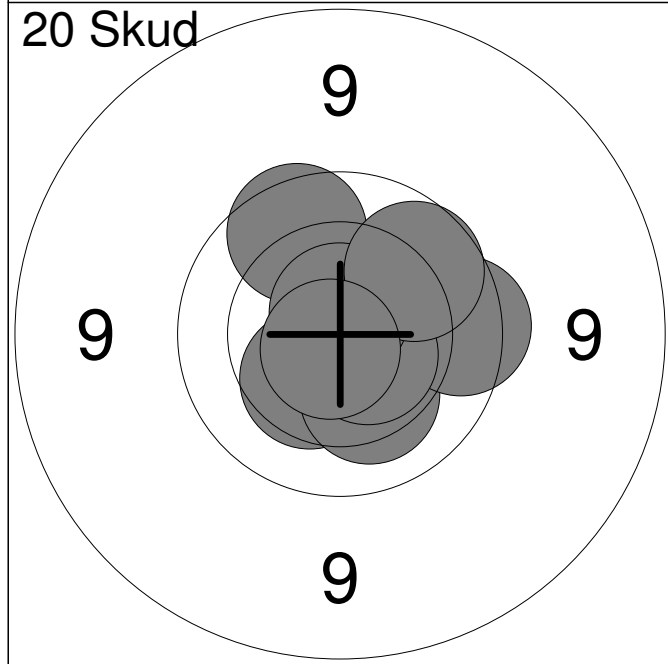

1:	10.5	↘
2:	10.4	↙
3:	10.2	↓
4:	10.6x	→
5:	9.8	→
6:	9.8	↗
7:	10.6x	↘
8:	10.7x	↑
9:	9.9	↗
10:	10.8x	↙
Serie		97.0
Total		97.0

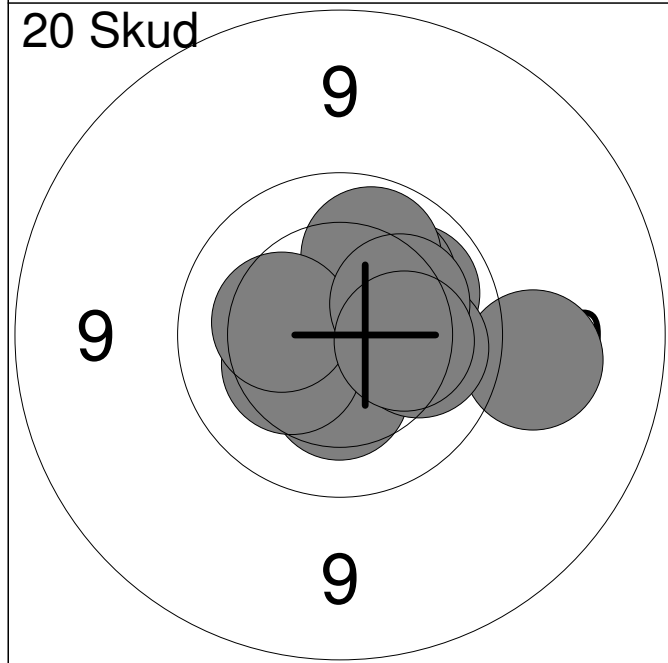

11:	9.3	→
12:	10.4	↓
13:	10.1	↗
14:	10.2	↗
15:	10.1	→
16:	10.0	↗
17:	10.3	↙
18:	10.3	↙
19:	10.2	↗
20:	10.2	→
Serie		99.0
Total		196.0

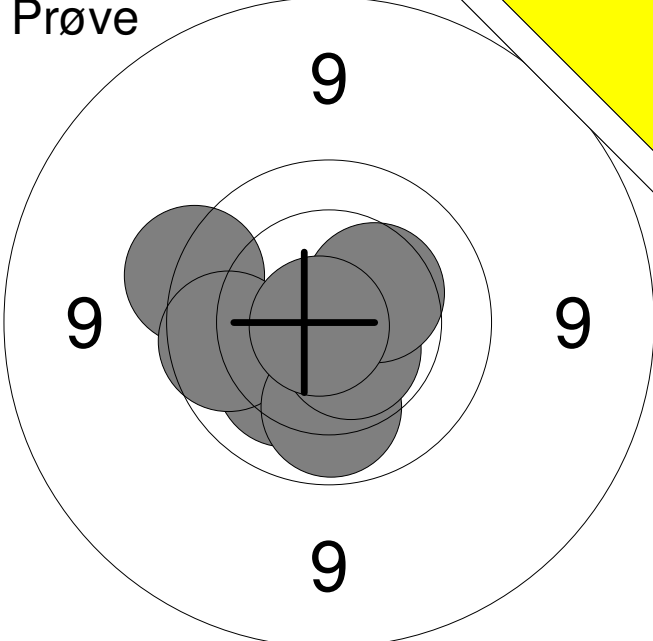
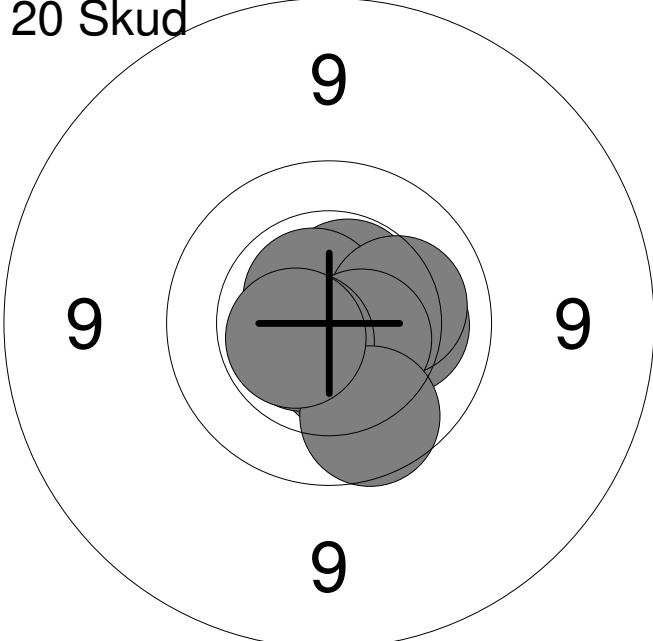
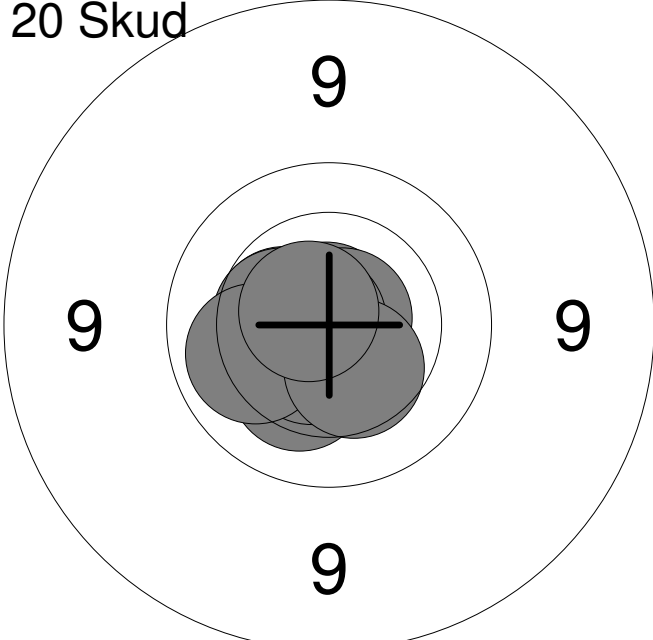
Hold	Skive	Bodil Abildgaard		
80	12	Hobro Egnens Skytteforening		ÅK1
24.10.2013	15 meter riffelstævne 2013		Aalborg Skyttekreds	
Prøve		1:	9.6	↖
		2:	10.2	↙
		3:	9.9	↖
		4:	10.0	↘
		5:	10.6x	↘
		6:	10.4	↗
		7:	10.8x	↖
		Serie	68.0	
		Total	0.0	
20 Skud		1:	10.5x	↗
		2:	10.2	→
		3:	10.5x	↘
		4:	10.5x	↗
		5:	10.6x	↗
		6:	10.2	→
		7:	10.6x	↘
		8:	10.6x	↖
		9:	9.9	↘
		10:	10.6x	↖
		Serie	99.0	
		Total	99.0	
20 Skud		11:	10.3	↘
		12:	10.5	↖
		13:	10.6x	↘
		14:	10.8x	↗
		15:	10.8x	↗
		16:	10.8x	↖
		17:	10.5	↖
		18:	10.1	↖
		19:	10.4	↘
		20:	10.7x	↗
		Serie	100.0	
		Total	199.0	

Hold 81	Skive 1	Esben Pallisgaard	
-------------------	-------------------	--------------------------	--

15m	Mou & Omegns Skf.	MJ2	
-----	-------------------	-----	--

24.10.2013	15 meter riffelstævne 2013	Aalborg Skyttekreds	
------------	----------------------------	---------------------	--

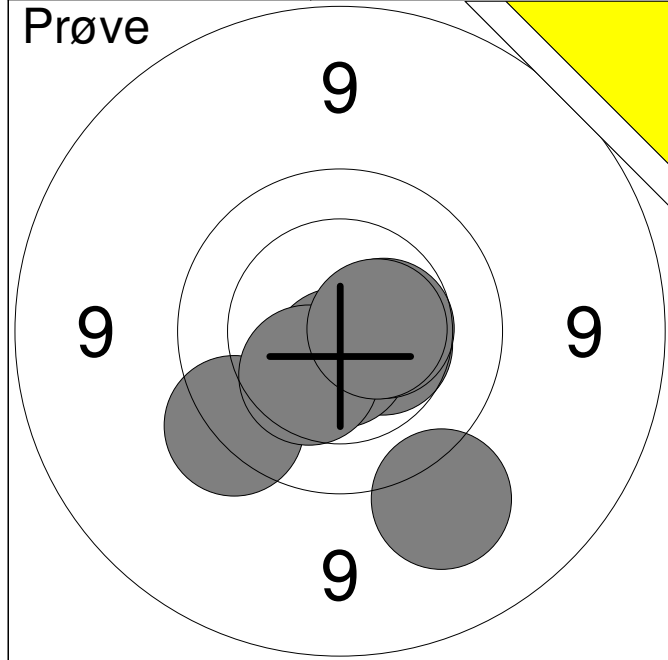

1:	9.3	↘
2:	10.5	→
3:	10.7x	↓
4:	10.5	→
5:	9.6	↙
6:	10.4	↙
7:	10.6x	→
Serie		68.0
Total		0.0

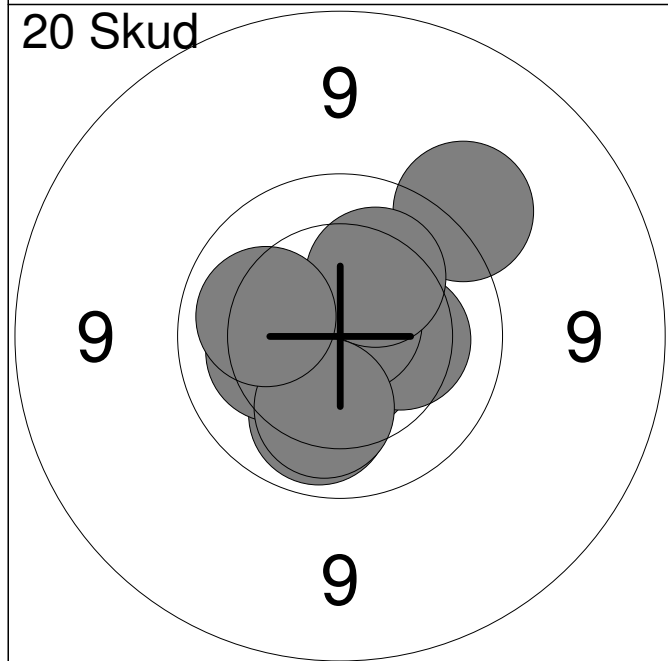

1:	10.8x	↗
2:	10.7x	↓
3:	10.3	→
4:	10.1	↓
5:	10.2	←
6:	10.8x	↗
7:	9.4	↗
8:	10.2	↗
9:	10.2	↓
10:	10.1	←
Serie		99.0
Total		99.0

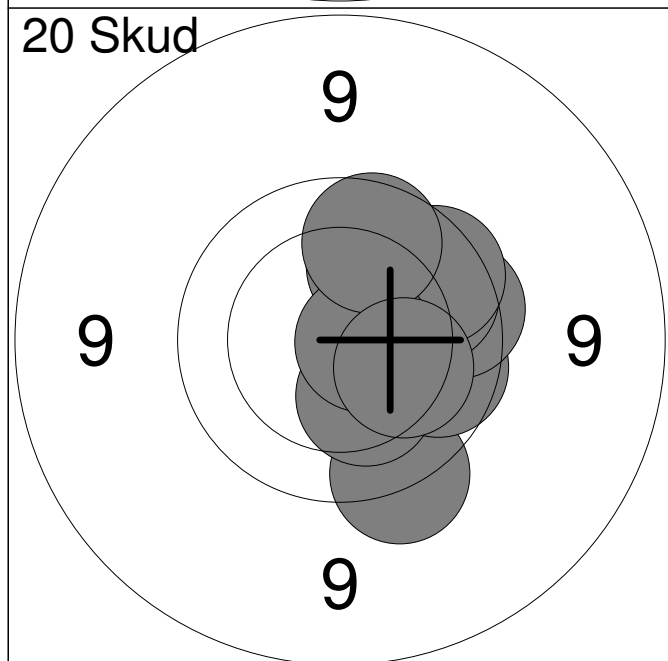

11:	9.6	↓
12:	9.9	→
13:	9.8	→
14:	10.1	↗
15:	10.3	↓
16:	9.9	↗
17:	9.8	↗
18:	10.7x	→
19:	9.9	↗
20:	10.2	↘
Serie		94.0
Total		193.0

Hold 81	Skive 2	Charlotte Pallisgaard	
-------------------	-------------------	------------------------------	--

15m	Mou & Omegns Skf.	MÅ3
-----	-------------------	-----

24.10.2013	15 meter riffelstævne 2013	Aalborg Skyttekreds
------------	----------------------------	---------------------

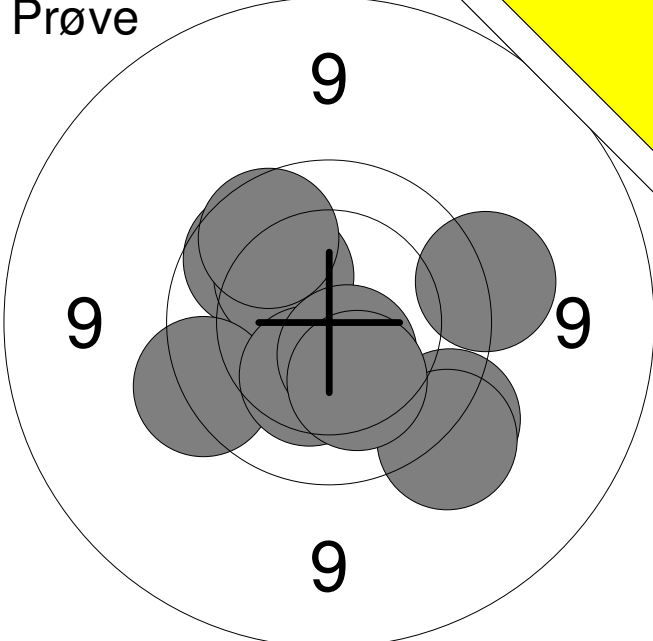
Prøve 	1:	9.9	↗
	2:	9.6	↘
	3:	9.5	↘
	4:	10.2	↗
	5:	9.9	↗
	6:	9.7	↖
	7:	9.5	→
	8:	10.3	↘
	9:	10.5x	↘
	10:	10.2	↘
	Serie		94.0
Total		0.0	

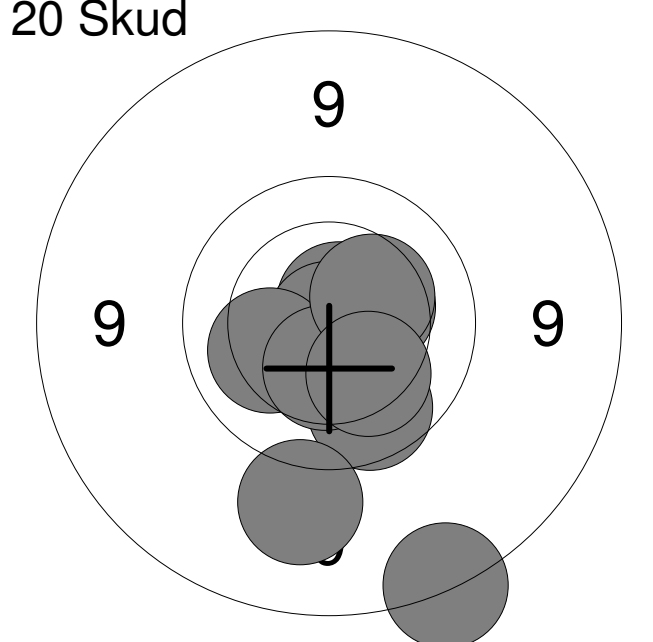
20 Skud 	1:	10.7x	↗
	2:	9.9	↘
	3:	8.7	↘
	4:	10.9x	↘
	5:	10.2	↖
	6:	10.4	→
	7:	10.4	↘
	8:	10.3	↗
	9:	10.2	↘
	10:	9.3	↘
	Serie		96.0
Total		96.0	

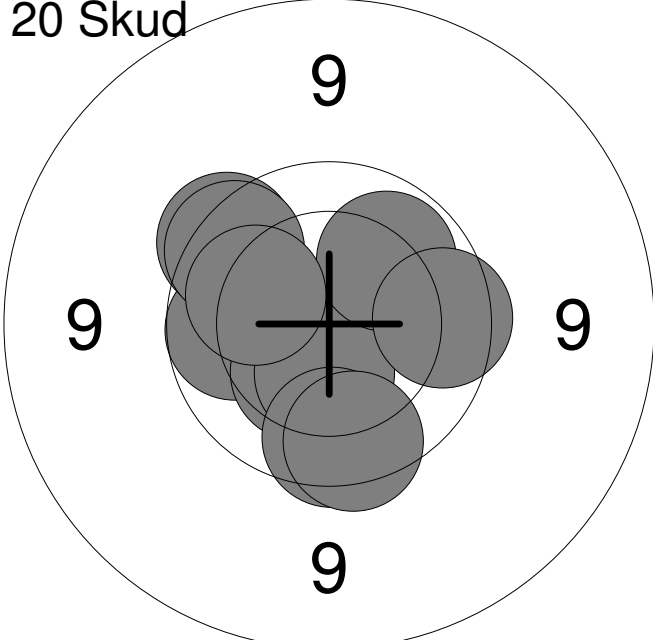
20 Skud 	11:	9.9	←
	12:	9.7	↗
	13:	10.3	↘
	14:	10.4	↘
	15:	10.0	↗
	16:	9.8	↘
	17:	9.8	↗
	18:	10.1	↗
	19:	9.8	↘
	20:	9.8	→
	Serie		94.0
Total		190.0	

Hold	Skive	Knud Møller	
81	3		
15m	Samsø Skytteforening	V1	
24.10.2013	15 meter riffelstævne 2013	Aalborg Skyttekreds	
Prøve 	1:	10.0	→
	2:	10.8x	↗
	3:	9.9	→
	4:	10.6	↗
	5:	10.4	↗
	6:	10.1	←
	7:	10.4	←
	8:	10.3	↘
	9:	10.5	↗
	10:	10.6x	←
	Serie		99.0
Total		0.0	
20 Skud 	1:	10.7x	↓
	2:	10.3	↓
	3:	10.8x	↗
	4:	10.6x	↘
	5:	10.7x	↗
	6:	10.8x	↘
	7:	10.2	←
	8:	10.4	↘
	9:	10.5	↘
	10:	10.3	↗
	Serie		100.0
Total		100.0	
20 Skud 	11:	10.6	↘
	12:	10.4	↗
	13:	10.3	↗
	14:	10.6	↘
	15:	10.5	↗
	16:	10.1	↗
	17:	10.9x	↘
	18:	10.7x	↗
	19:	10.9x	↘
	20:	10.4	↗
	Serie		100.0
Total		200.0	

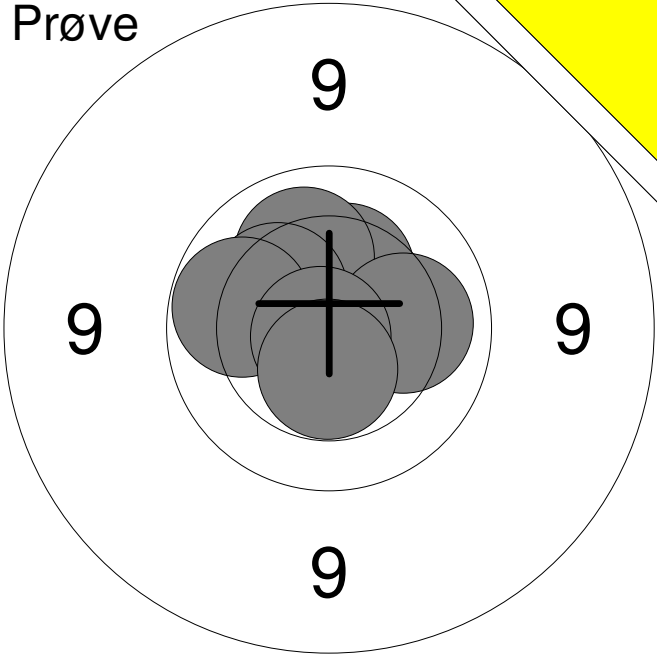
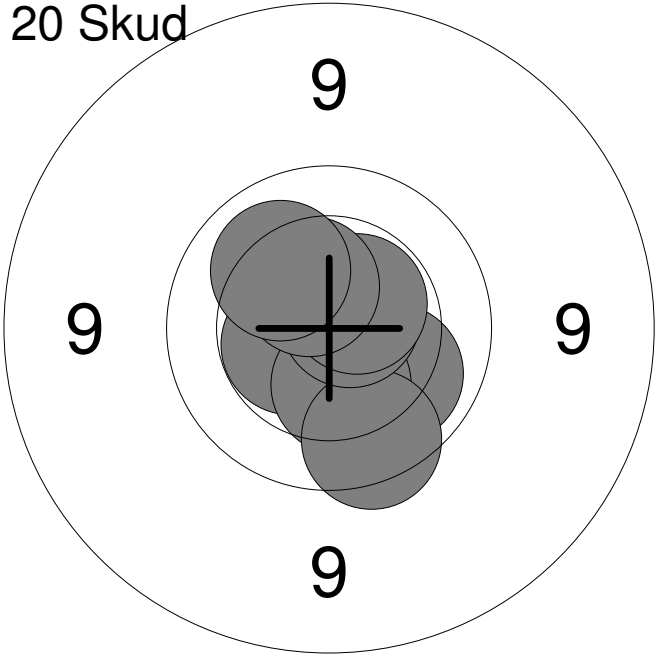
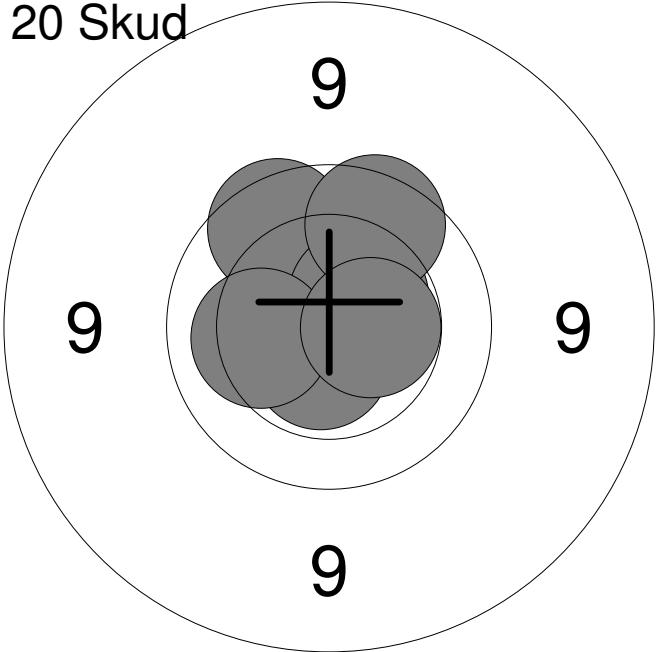
Hold	Skive	Bodil Abildgaard		
81	4	Hobro Egnens Skytteforening		MÅ1
24.10.2013	15 meter riffelstævne 2013		Aalborg Skyttekreds	
Prøve 	1:	10.4	↑	
	2:	10.3	↖	
	3:	10.5x	↑	
	4:	10.3	↑	
	5:	10.1	↑	
	6:	10.1	→	
	7:	10.3	↗	
	8:	10.0	↖	
	9:	10.8x	↙	
	10:	10.5x	↓	
	Serie			100.0
Total			0.0	
20 Skud 	1:	10.1	↘	
	2:	10.7x	↓	
	3:	10.8x	↖	
	4:	10.5x	↖	
	5:	10.3	↓	
	6:	9.8	↓	
	7:	10.7x	↗	
	8:	10.6x	↗	
	9:	10.5	↑	
	10:	10.1	↗	
	Serie			99.0
Total			99.0	
20 Skud 	11:	10.6x	↗	
	12:	10.7x	↖	
	13:	10.7x	↖	
	14:	10.3	↑	
	15:	10.6x	↓	
	16:	9.8	↑	
	17:	10.5x	↗	
	18:	10.2	↖	
	19:	9.8	↑	
	20:	10.5x	→	
	Serie			98.0
Total			197.0	

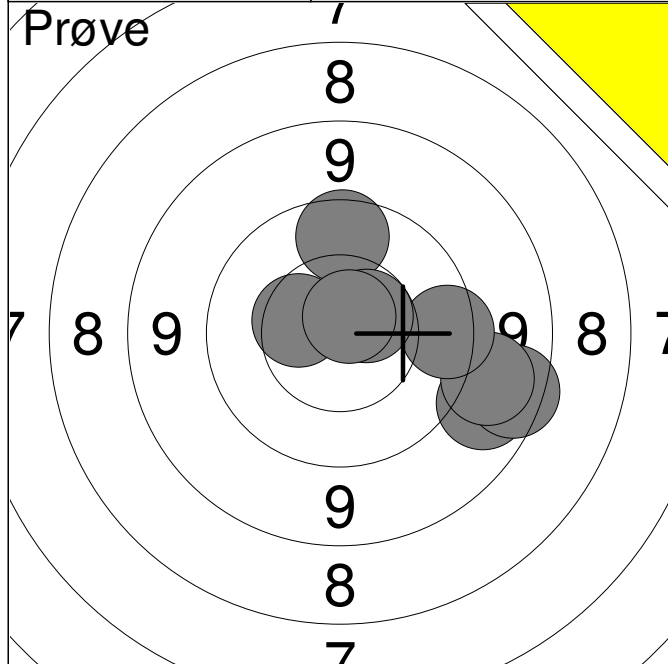

1:	9.0	↘
2:	8.7	↘
3:	9.1	↘
4:	10.4	↖
5:	9.8	↑
6:	9.7	→
7:	10.6	↗
8:	10.7x	↗
Serie		74.0
Total		0.0

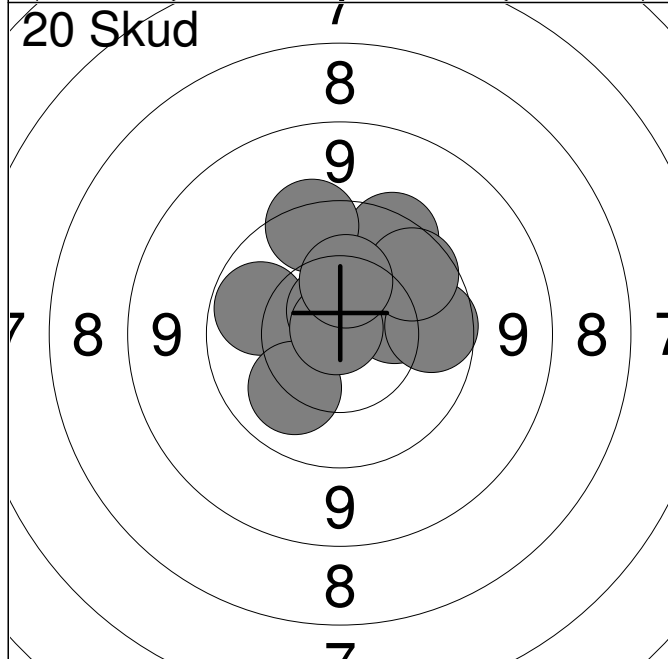

1:	9.7	↗
2:	10.0	↖
3:	10.7x	↗
4:	9.6	↗
5:	10.3	→
6:	9.9	→
7:	9.9	↗
8:	10.1	↖
9:	10.9x	↗
10:	10.3	↗
Serie		96.0
Total		96.0

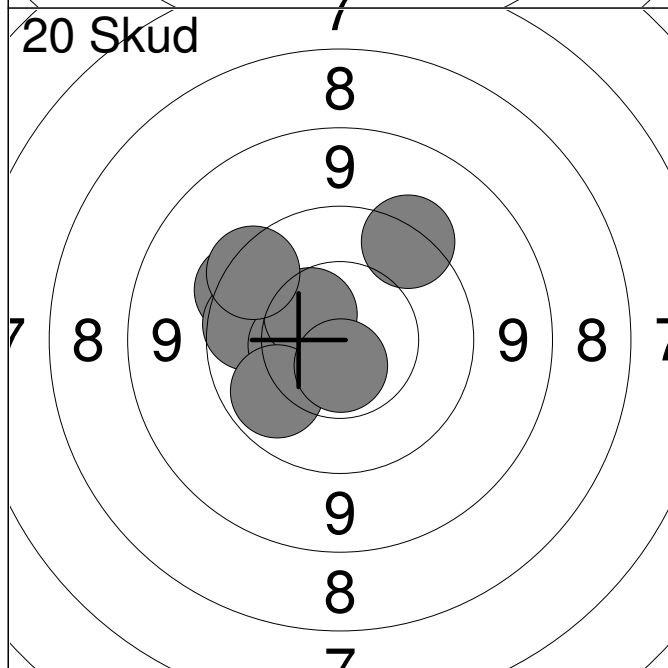

11:	9.6	↖
12:	10.2	↖
13:	9.9	↖
14:	10.6	↗
15:	10.4	↖
16:	10.5	↗
17:	10.0	↖
18:	9.7	↗
19:	9.5	↗
20:	10.7x	↓
Serie		96.0
Total		192.0

Hold 81	Skive 6	Nikoline Svendsen	
-------------------	-------------------	--------------------------	--

15m	Vester Hassing Skf.	MJ2	
-----	---------------------	-----	--

24.10.2013	15 meter riffelstævne 2013	Aalborg Skyttekreds	
------------	----------------------------	---------------------	--

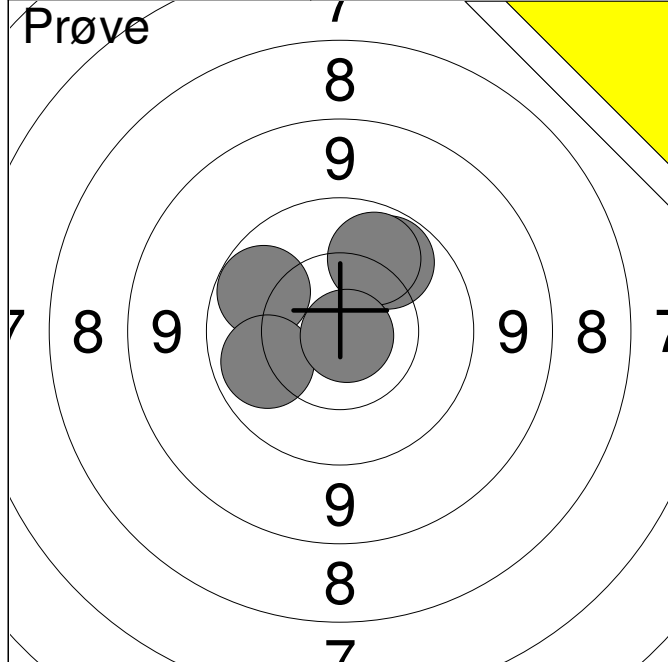

1:	10.0	↗
2:	10.0	↗
3:	10.0	↗
4:	10.0	↖
5:	10.9x	↘
Serie		50.0
Total		0.0

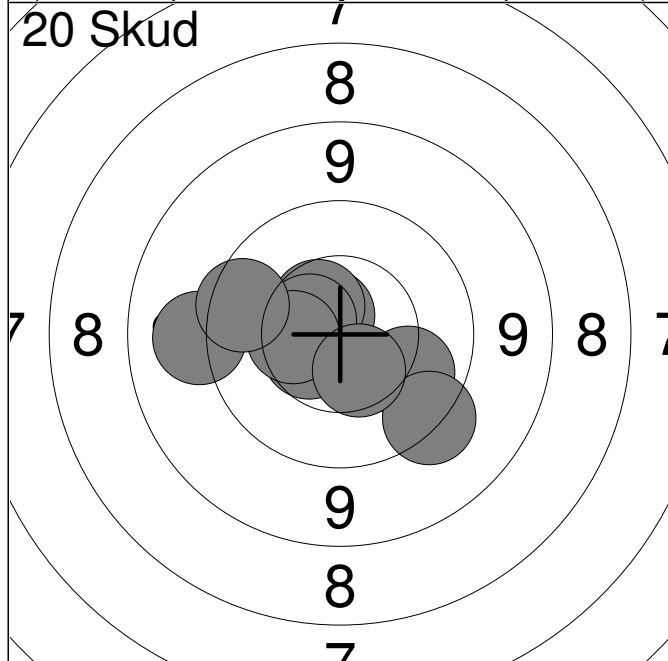

1:	10.7x	↗
2:	10.0	↘
3:	9.5	↘
4:	10.5	↗
5:	9.3	↖
6:	10.5	↖
7:	10.6	↗
8:	10.4	↖
9:	9.8	↗
10:	10.5	↘
Serie		97.0
Total		97.0

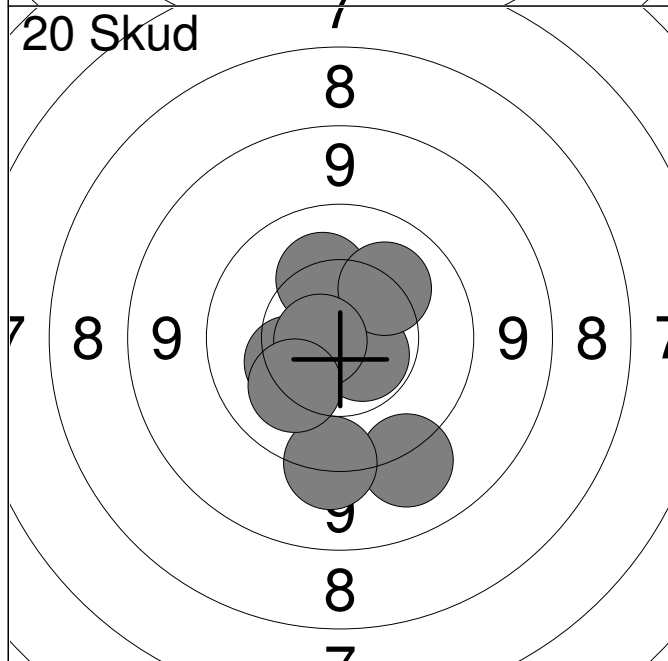

11:	10.9x	↗
12:	10.3	↖
13:	10.2	↗
14:	10.8x	↘
15:	10.6x	↘
16:	9.3	↘
17:	10.2	↗
18:	9.5	↘
19:	10.7x	↖
20:	10.2	↘
Serie		98.0
Total		195.0

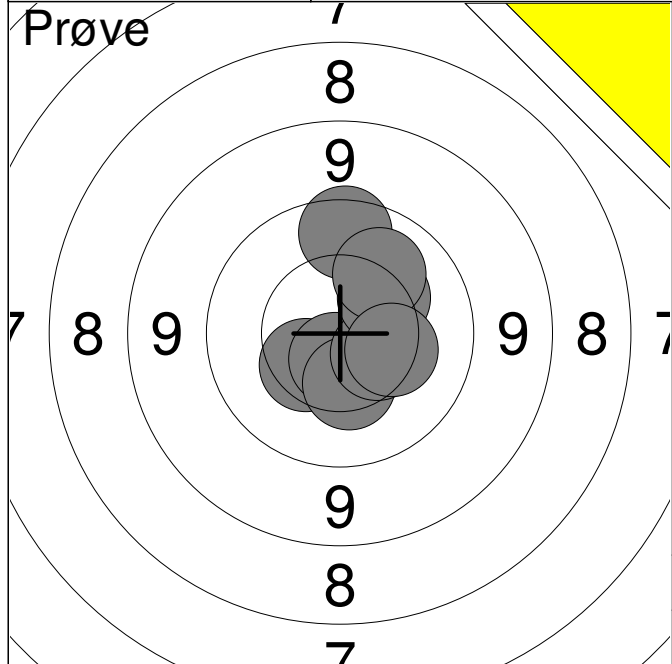

1:	10.4	↙
2:	10.7x	↓
3:	10.4	↓
4:	10.5	→
5:	10.3	↗
6:	9.8	↑
7:	10.1	↗
8:	10.3	→
Serie		79.0
Total		0.0

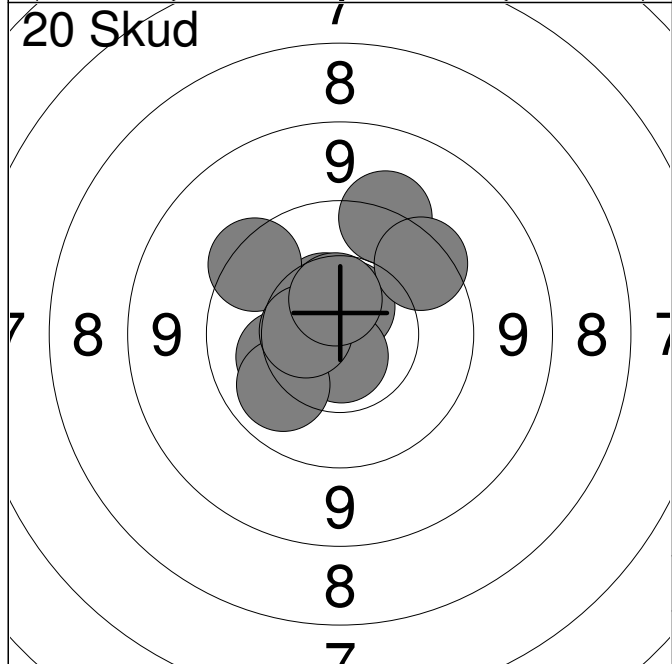

1:	10.6x	↑
2:	10.5	↑
3:	9.5	↑
4:	9.7	↗
5:	10.7x	↓
6:	10.2	←
7:	10.1	←
8:	9.7	↗
9:	10.6	←
10:	10.5	↑
Serie		97.0
Total		97.0

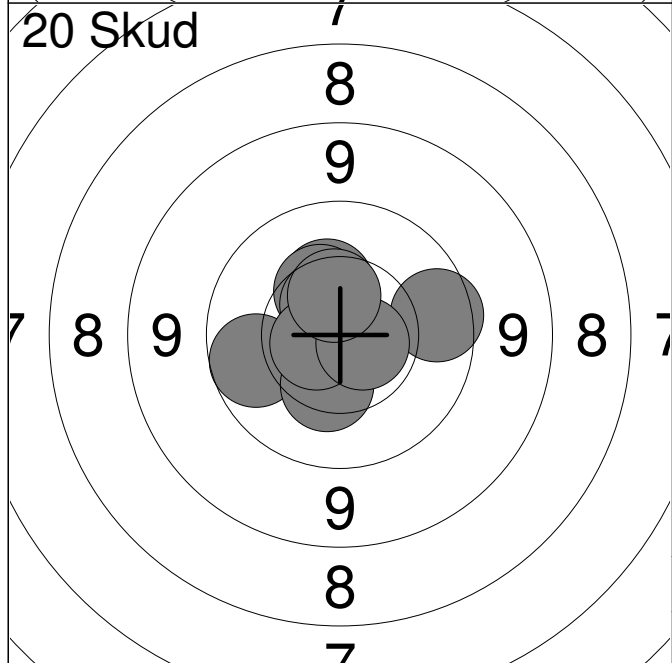

11:	9.9	←
12:	10.4	↑
13:	10.4	↑
14:	10.8x	←
15:	9.8	→
16:	10.4	↓
17:	10.6	↑
18:	10.7x	←
19:	10.7x	→
20:	10.5	↑
Serie		98.0
Total		195.0

Hold	Skive	Jørgen Thomsen		
81	8	15m	Hobro Egnens Skytteforening	
24.10.2013	15 meter riffelstævne 2013	ÅK1		
Prøve		Aalborg Skyttekreds		
	1:	10.0	↘	
	2:	10.4	↙	
	3:	9.5	↘	
	4:	10.3	↘	
	5:	10.4	↘	
	6:	10.2	↘	
	7:	10.7x	↙	
	Serie		69.0	
Total		0.0		
20 Skud		1:	10.1	↖
		2:	10.1	→
		3:	9.8	←
		4:	10.7x	←
		5:	10.5	↘
		6:	10.8x	↗
		7:	10.1	↗
		8:	10.7x	→
		9:	10.4	↗
		10:	10.9x	→
Serie		99.0		
Total		99.0		
20 Skud		11:	10.1	↘
		12:	10.5	←
		13:	10.2	→
		14:	10.5	←
		15:	10.3	↗
		16:	10.6x	←
		17:	10.3	↖
		18:	10.8x	↘
		19:	10.8x	→
		20:	10.2	↖
Serie		100.0		
Total		199.0		

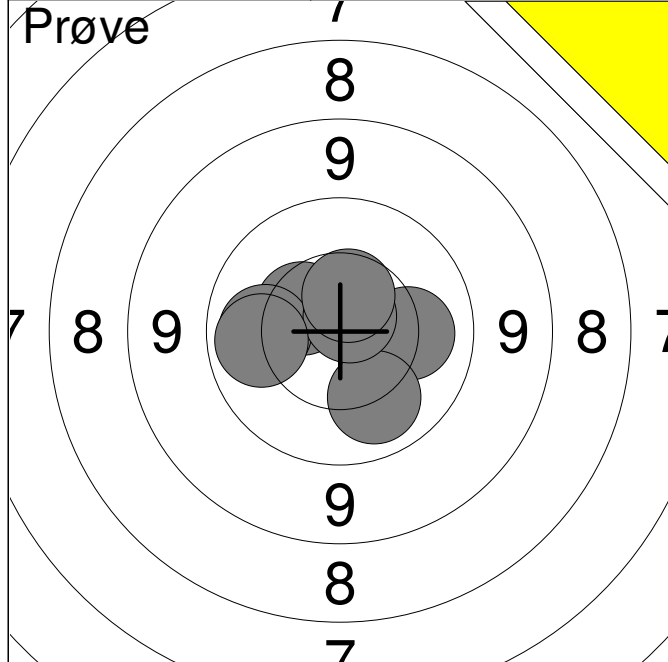

1:	10.4	↗
2:	10.2	→
3:	10.1	↘
4:	10.1	←
5:	10.7x	↗
6:	10.0	←
7:	10.5	↑
Serie		70.0
Total		0.0

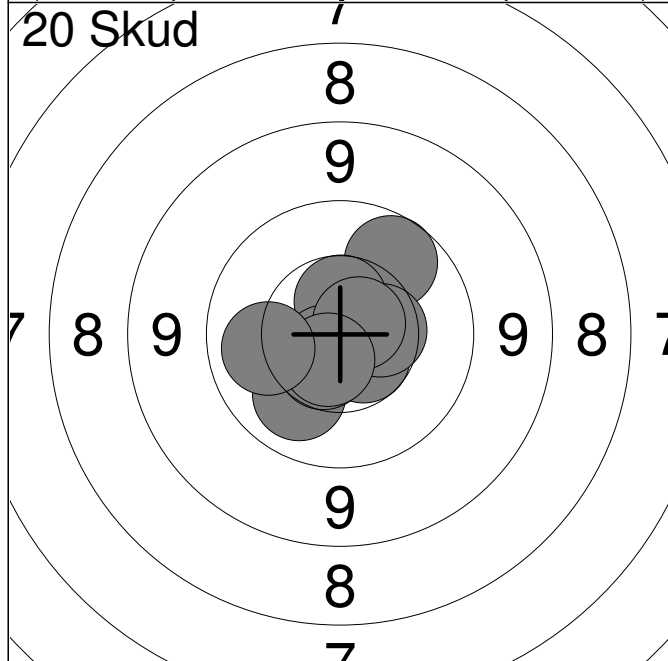

1:	9.9	↗
2:	10.6	↑
3:	10.1	↘
4:	10.6	↘
5:	10.5	→
6:	10.7x	↘
7:	10.6	↘
8:	10.7x	↗
9:	10.6x	↘
10:	10.1	←
Serie		99.0
Total		99.0

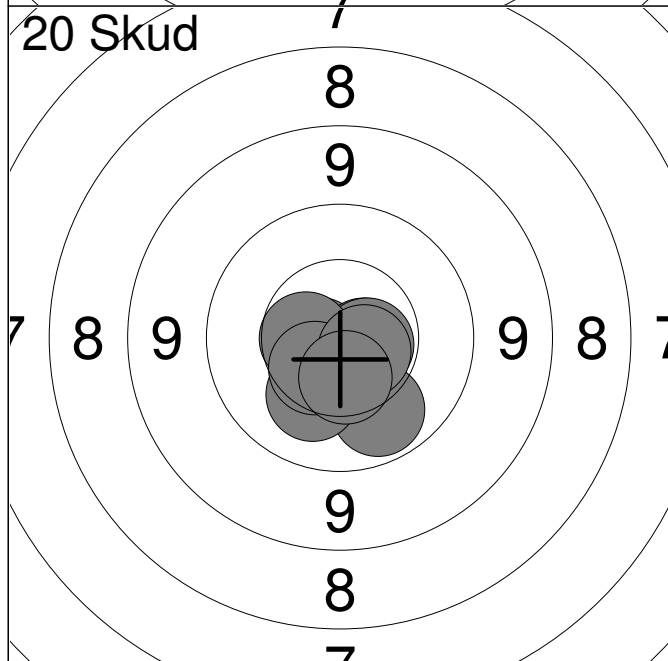

11:	10.7x	←
12:	10.6	↘
13:	10.0	↘
14:	10.7x	→
15:	10.6x	→
16:	10.6	←
17:	10.2	↘
18:	10.5	↘
19:	10.6x	↘
20:	10.5	↘
Serie		100.0
Total		199.0

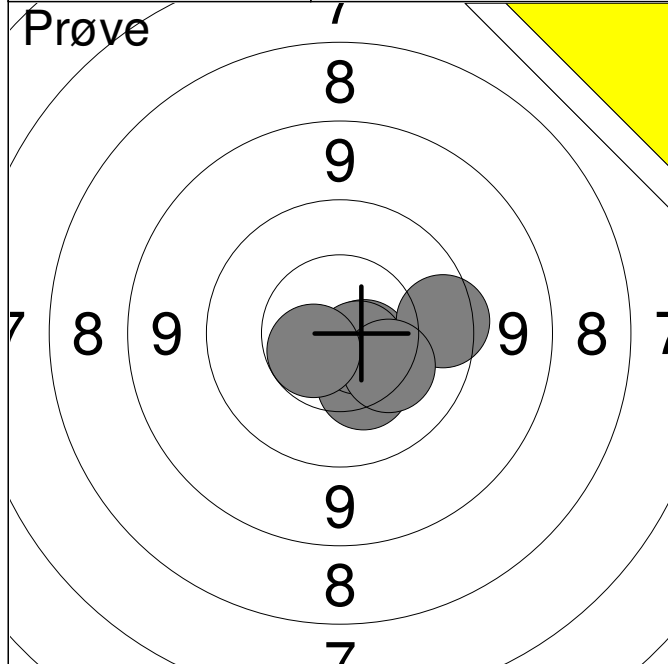

1:	10.3	↘
2:	10.6x	↘
3:	9.7	→
4:	10.7x	↘
5:	10.3	↘
6:	10.6	↙
Serie	59.0	
Total	0.0	

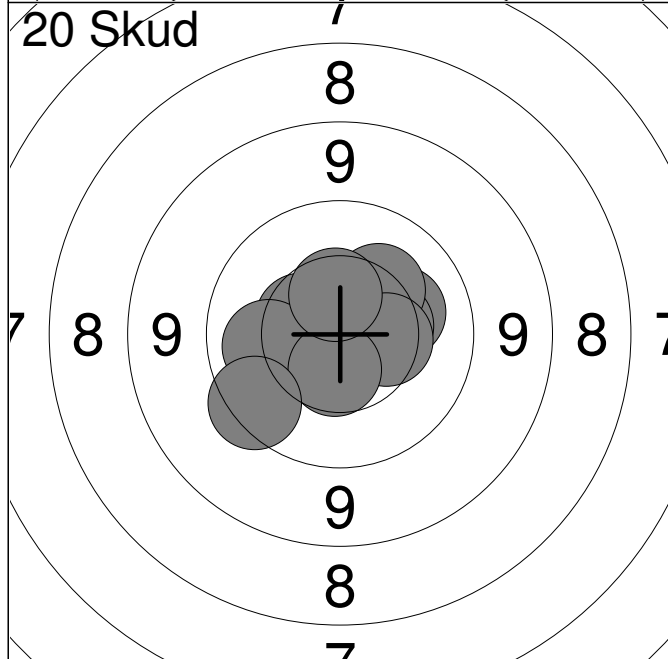

1:	10.5	↖
2:	10.2	→
3:	10.4	→
4:	10.3	↗
5:	10.8x	↘
6:	10.1	↖
7:	10.4	→
8:	10.5	↘
9:	10.5	↑
10:	9.7	↙
Serie	99.0	
Total	99.0	

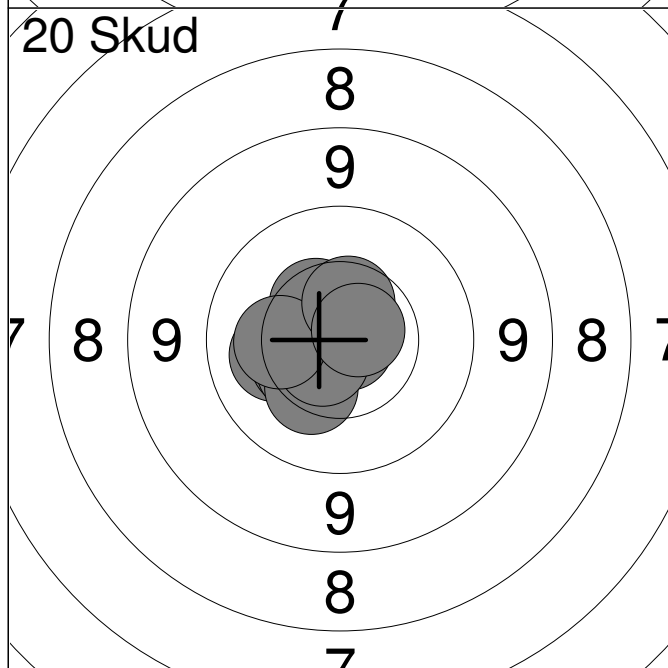

11:	10.5	↗
12:	10.2	↖
13:	10.4	↖
14:	10.4	↖
15:	10.3	↘
16:	10.9x	↘
17:	10.6x	↖
18:	10.3	↖
19:	10.5	↑
20:	10.7x	↗
Serie	100.0	
Total	199.0	

Hold 81	Skive 11	Arne Schiønning	
-------------------	--------------------	------------------------	--

15m	Aalborg Skyttekreds	V1	
-----	---------------------	----	--

24.10.2013	15 meter riffelstævne 2013	Aalborg Skyttekreds	
------------	----------------------------	---------------------	--

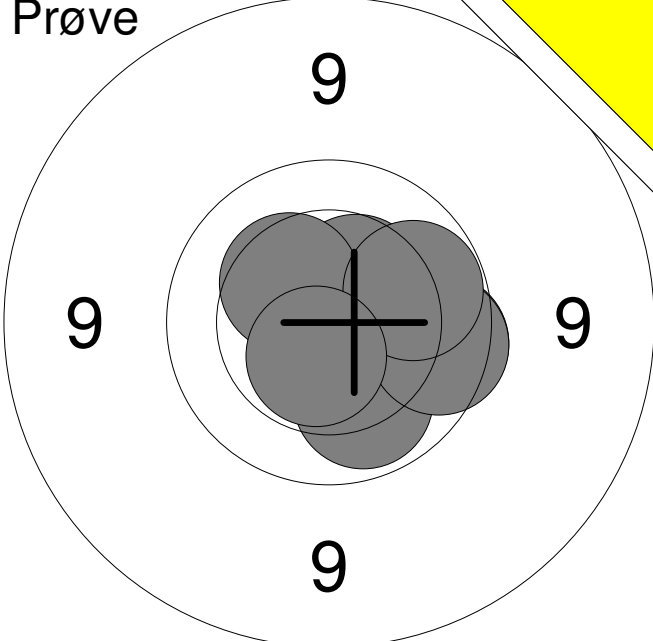
Prøve 	1: 10.4 ↗ 2: 10.1 ↓ 3: 9.8 → 4: 10.4 ↗ 5: 9.8 → 6: 10.0 → 7: 10.6x ↓
	Serie 68.0 Total 0.0

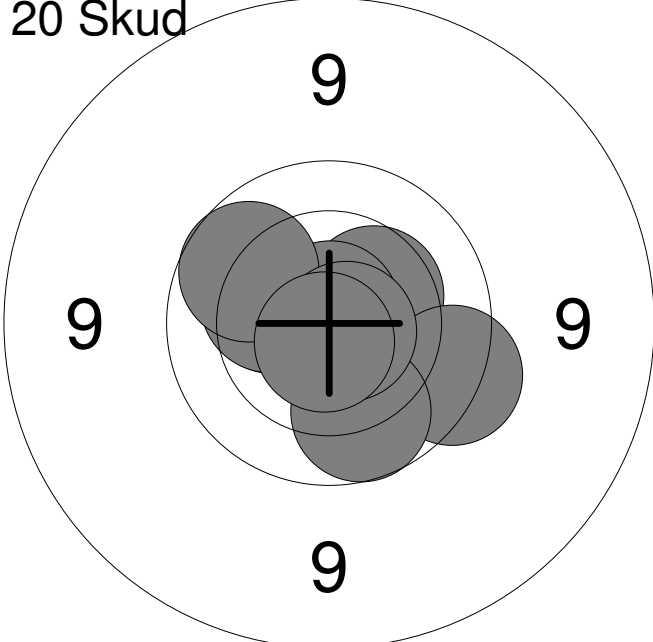
20 Skud 	1: 10.3 ↖ 2: 10.4 ↗ 3: 9.7 → 4: 10.3 ↖ 5: 9.9 ↓ 6: 10.8x ↑ 7: 10.8x ↑ 8: 9.9 ↗ 9: 10.7x → 10: 10.7x ↓
	Serie 97.0 Total 97.0

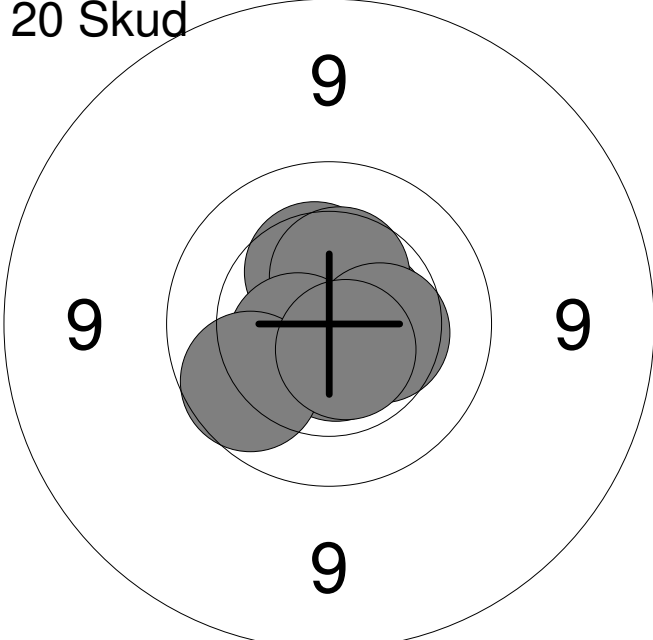
20 Skud 	11: 10.7x → 12: 10.4 ↑ 13: 10.6x → 14: 10.6x ↓ 15: 10.8x ↓ 16: 10.4 ↑ 17: 10.6x ↖ 18: 10.4 → 19: 9.9 ↖ 20: 10.6x ↓
	Serie 99.0 Total 196.0

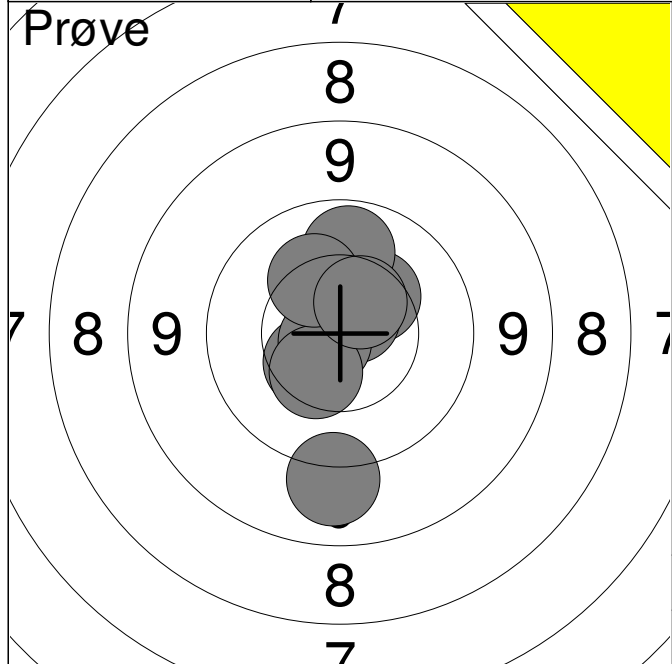

1:	10.4	↗
2:	10.7x	↗
3:	10.5	↘
4:	10.8x	↙
5:	10.0	↑
6:	10.4	↘
7:	9.2	↓
8:	10.3	↗
9:	10.5	↗
Serie	89.0	
Total	0.0	

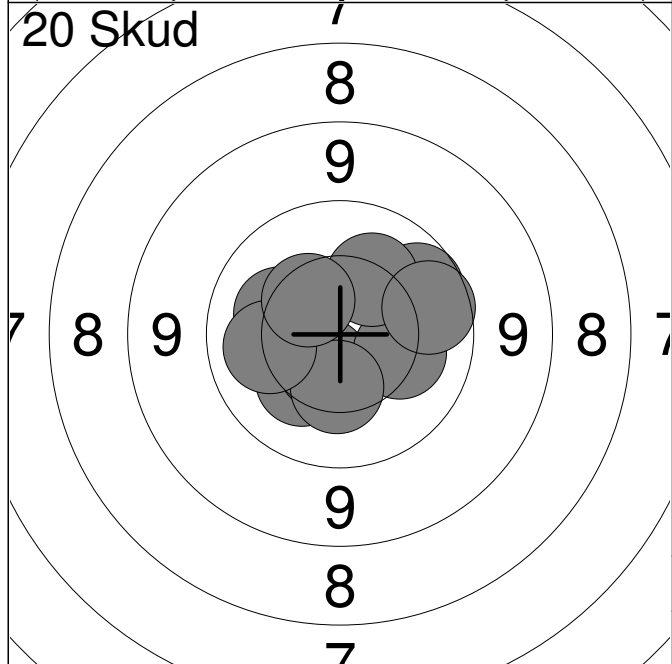

1:	10.3	↘
2:	10.6	↘
3:	10.2	→
4:	9.9	↗
5:	10.3	↓
6:	10.2	↖
7:	10.1	←
8:	10.2	↗
9:	9.9	→
10:	10.4	↗
Serie	98.0	
Total	98.0	

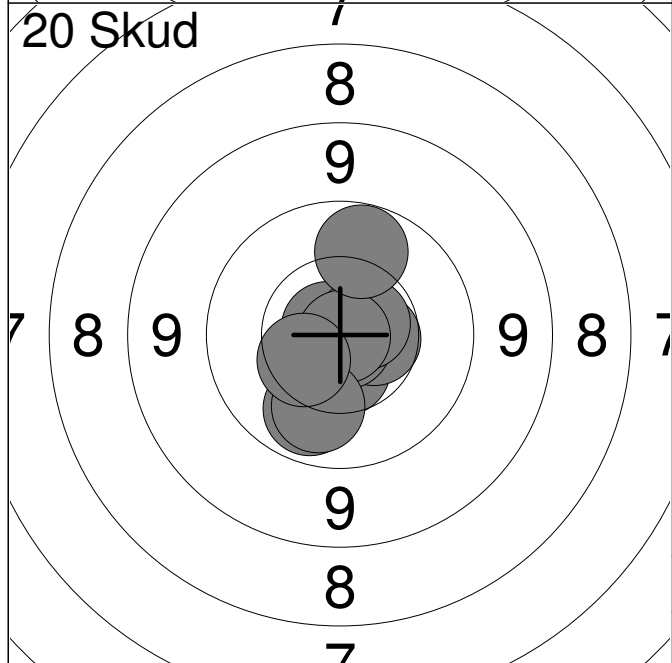

11:	10.8x	↗
12:	10.6	↓
13:	10.6	→
14:	10.8x	↘
15:	10.6x	↗
16:	10.9x	→
17:	10.0	↘
18:	10.1	↘
19:	10.0	↗
20:	10.4	↙
Serie	100.0	
Total	198.0	

Hold 82	Skive 1	Frederik Hedemann
-------------------	-------------------	--------------------------

15m	Vester Hassing Skf.	MJ2
-----	---------------------	-----

24.10.2013	15 meter riffelstævne 2013	Aalborg Skyttekreds
------------	----------------------------	---------------------

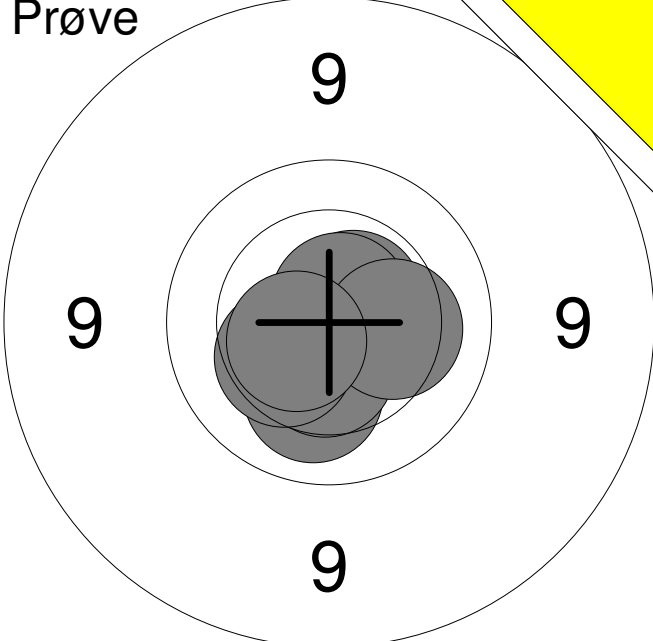
Prøve 	1: 10.2	↓
	2: 10.6x	↗
	3: 10.5	↓
	4: 10.3	↙
	5: 10.7x	↗
	6: 10.3	→
	7: 10.5x	↙
	Serie	70.0
Total	0.0	

20 Skud 	1: 10.4	→
	2: 9.9	↘
	3: 10.5x	↙
	4: 10.4	↙
	5: 10.7x	→
	6: 10.2	↘
	7: 10.9x	↑
	8: 10.7x	↗
	9: 10.4	↘
	10: 10.5x	↑
	Serie	99.0
Total	99.0	

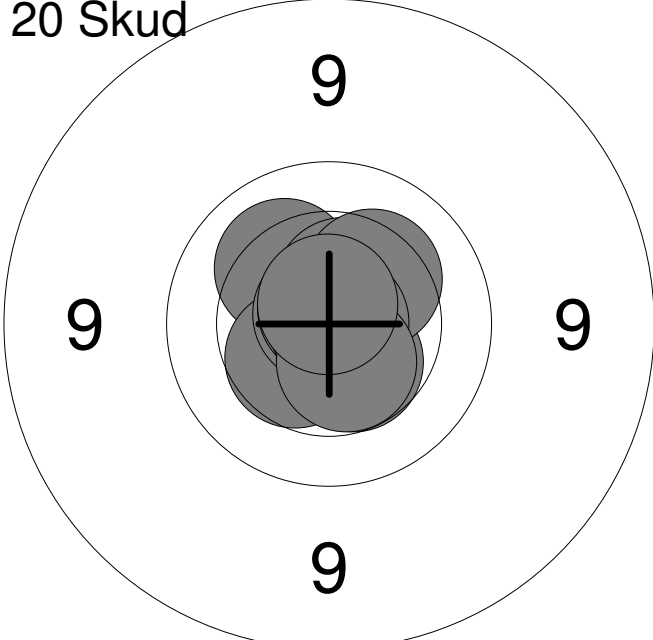
20 Skud 	11: 10.2	↗
	12: 10.4	↙
	13: 10.8x	↗
	14: 10.5	↙
	15: 10.5x	↗
	16: 10.3	↗
	17: 10.8x	↑
	18: 10.8x	→
	19: 10.5x	↙
	20: 10.7x	↑
	Serie	100.0
Total	199.0	

Hold 82	Skive 2	Christian Jensen
-------------------	-------------------	-------------------------

15m	Ribe Skyttekreds	ÅK1
-----	------------------	-----

24.10.2013	15 meter riffelstævne 2013	Aalborg Skyttekreds
------------	----------------------------	---------------------

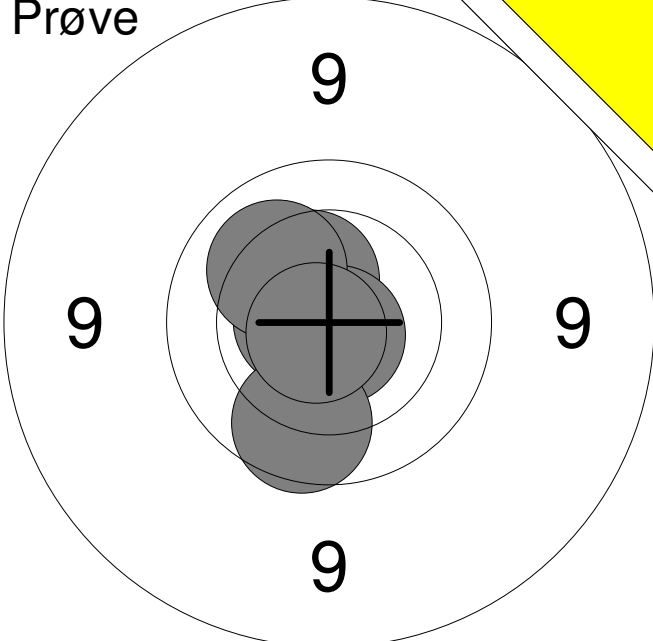
Prøve 	1: 10.7x ←
	2: 10.4 ↗
	3: 10.8x ↘
	4: 10.2 ↗
	5: 9.9 ↘
	6: 10.8x ↘
	Serie 59.0
	Total 0.0

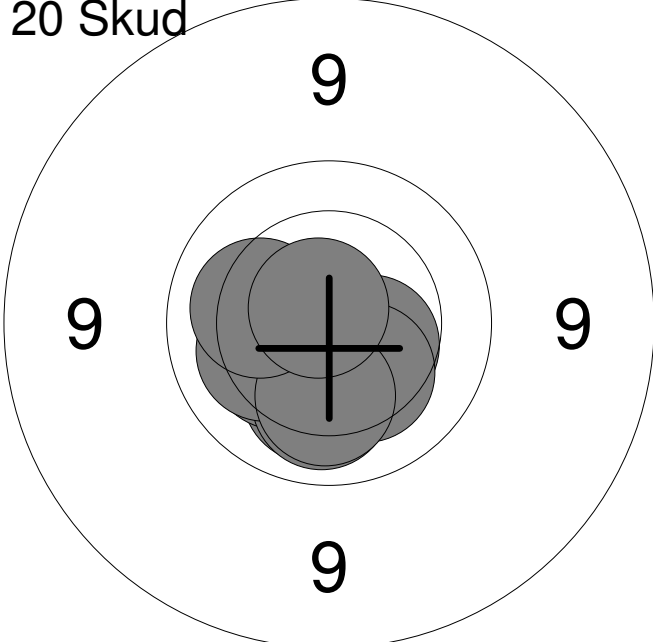
20 Skud 	1: 10.2 ←
	2: 10.5 ↘
	3: 10.2 ↘
	4: 10.3 ←
	5: 10.1 ↘
	6: 10.3 ↘
	7: 10.2 ←
	8: 10.2 ↘
	9: 10.2 ←
	10: 10.8x ↗
	Serie 100.0
	Total 100.0

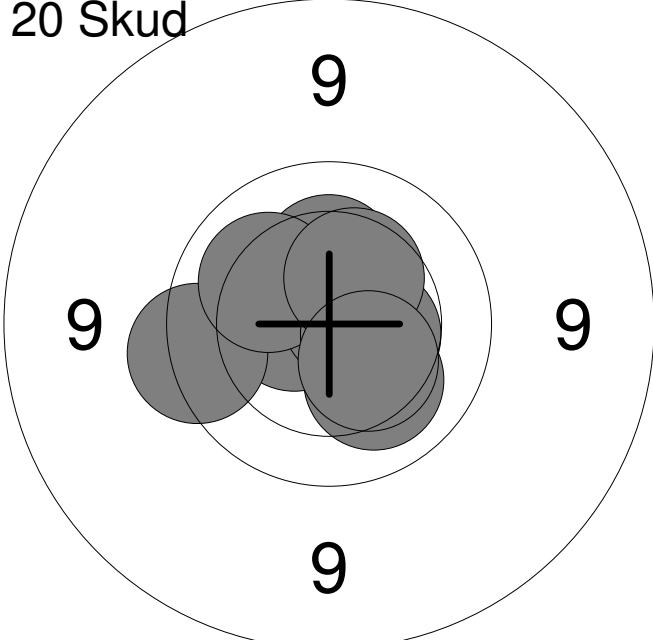
20 Skud 	11: 10.9x →
	12: 10.2 ↘
	13: 10.6x ←
	14: 10.7x ↗
	15: 10.3 ↑
	16: 9.7 ←
	17: 10.2 ↗
	18: 10.5 ↘
	19: 10.4 ↗
	20: 10.4 ↘
	Serie 99.0
	Total 199.0

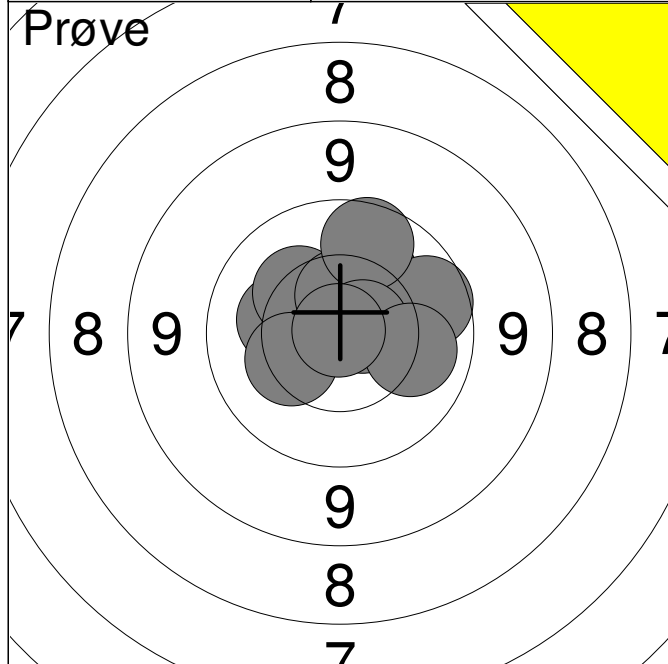

1:	10.3	←
2:	10.3	↗
3:	10.2	↗
4:	9.9	→
5:	10.5	↑
6:	9.9	↑
7:	10.7x	→
8:	10.3	←
9:	10.1	→
10:	10.9x	↑
Serie		98.0
Total		0.0

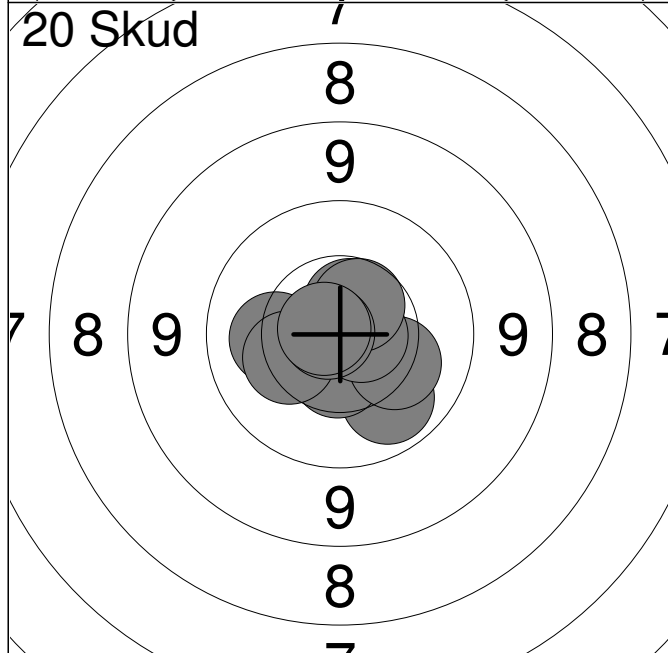

1:	10.0	↘
2:	10.6x	↑
3:	10.5	↘
4:	10.2	↘
5:	10.7x	→
6:	10.2	←
7:	10.3	←
8:	10.6	↗
9:	10.8x	←
10:	10.8x	←
Serie		100.0
Total		100.0

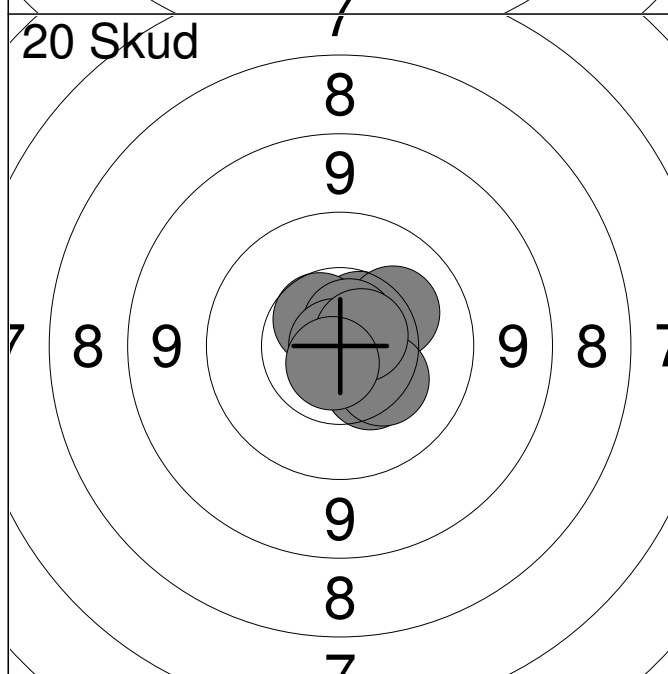

11:	10.6	↗
12:	10.2	↗
13:	10.6	↗
14:	10.7x	↗
15:	10.4	↘
16:	10.9x	←
17:	10.4	↘
18:	10.3	↘
19:	10.7x	→
20:	10.7x	↘
Serie		100.0
Total		200.0

Hold 82	Skive 4	Karsten Abildgaard	
-------------------	-------------------	---------------------------	--

15m	Hobro Egnens Skytteforening	ÅK1	
-----	-----------------------------	-----	--

24.10.2013	15 meter riffelstævne 2013	Aalborg Skyttekreds	
------------	----------------------------	---------------------	--

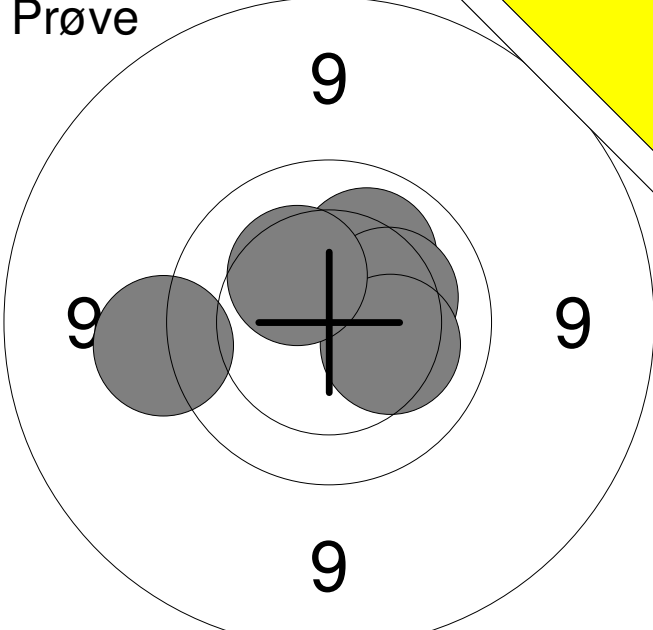
Prøve 	1: 9.5 ←
	2: 10.1 ↗
	3: 10.3 →
	4: 10.2 ↘
	5: 10.3 ↗
Serie	49.0
Total	0.0

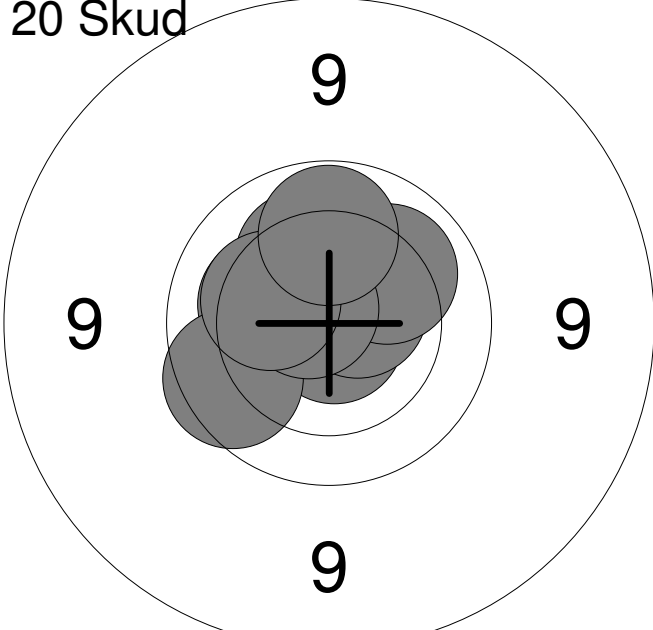
20 Skud 	1: 10.8x ↓
	2: 10.6x ↑
	3: 10.6x →
	4: 10.3 ←
	5: 9.8 ↙
	6: 10.1 ↗
	7: 10.2 ↑
	8: 10.7x ↗
	9: 10.3 ↙
	10: 10.0 ↑
Serie	99.0
Total	99.0

20 Skud 	11: 10.0 ←
	12: 9.7 ←
	13: 9.8 ↑
	14: 9.8 ↙
	15: 10.0 ↗
	16: 10.8x ↗
	17: 10.6x ↑
	18: 10.4 ↘
	19: 10.1 ↑
	20: 10.7x ↙
Serie	97.0
Total	196.0

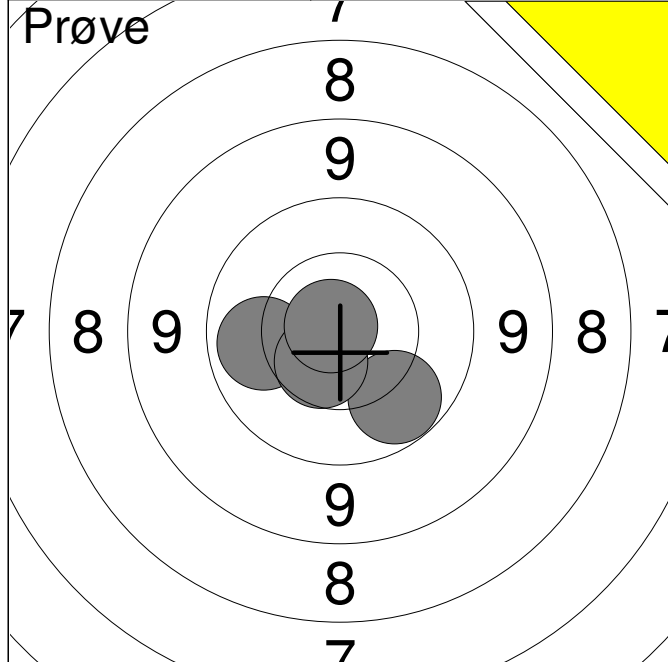

1:	10.0	↘
2:	10.1	←
3:	10.5	↘
4:	10.8x	↗
Serie	40.0	
Total	0.0	

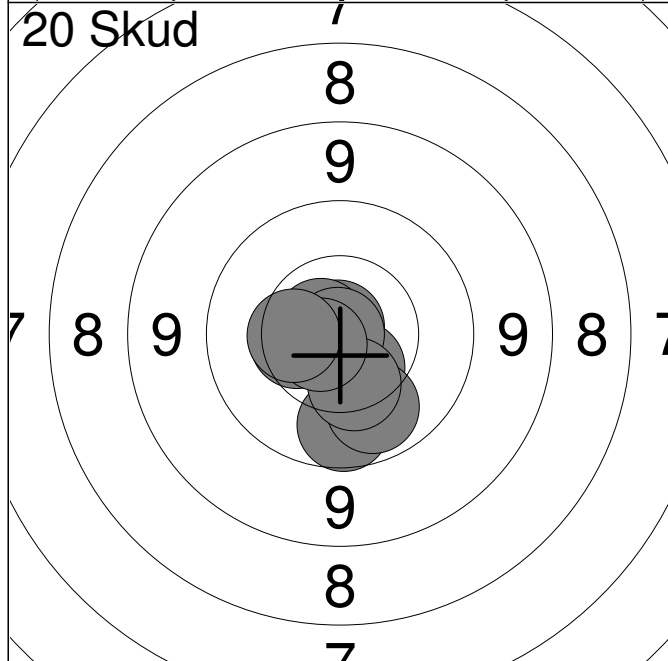

1:	10.9x	↗
2:	10.7x	↗
3:	10.5	↘
4:	10.4	←
5:	9.9	↘
6:	10.0	↘
7:	10.9x	←
8:	10.3	↘
9:	10.7x	←
10:	10.4	←
Serie	99.0	
Total	99.0	

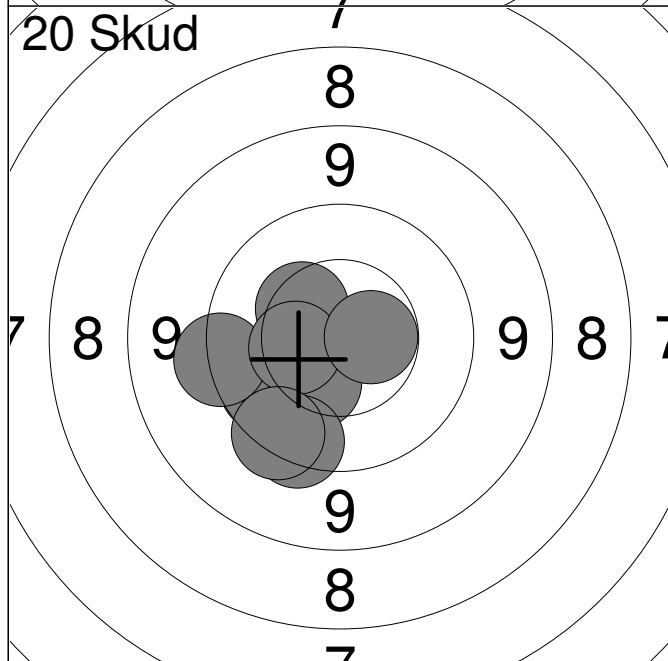

11:	9.9	←
12:	10.1	←
13:	10.2	←
14:	10.4	↗
15:	9.5	←
16:	10.4	↘
17:	9.6	↘
18:	10.4	←
19:	10.6x	→
20:	9.6	↘
Serie	96.0	
Total	195.0	

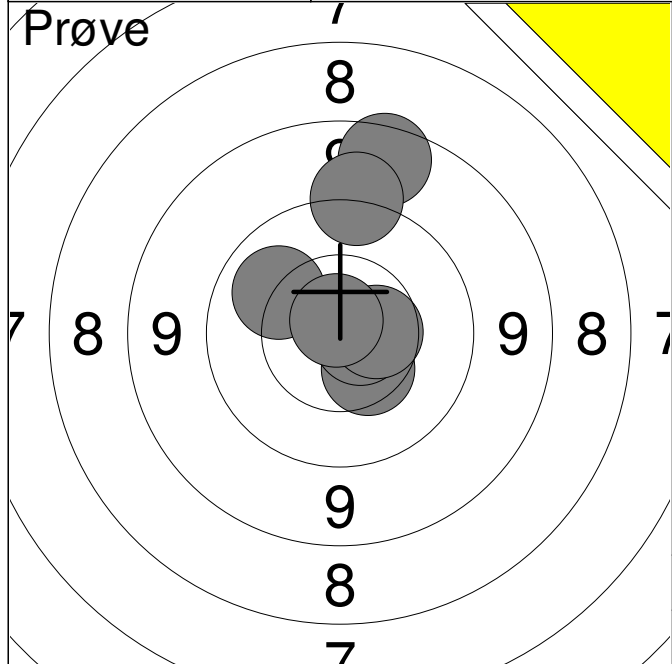

1:	8.8	↑
2:	10.1	↖
3:	9.3	↑
4:	10.4	↘
5:	10.7x	→
6:	10.5	→
7:	10.8x	↑
Serie		67.0
Total		0.0

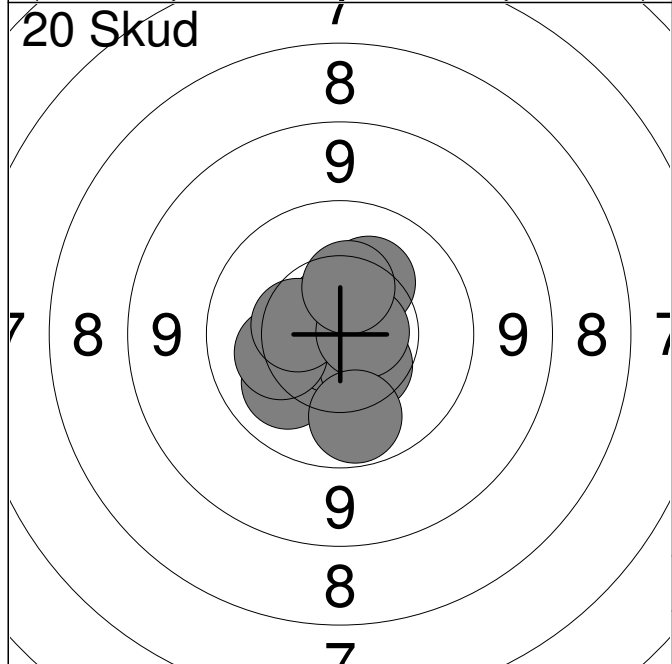

1:	10.1	↙
2:	10.8x	↘
3:	10.5	↘
4:	10.3	↗
5:	10.2	↖
6:	10.7x	↗
7:	10.4	↖
8:	10.7x	→
9:	10.0	↘
10:	10.4	↑
Serie		100.0
Total		100.0

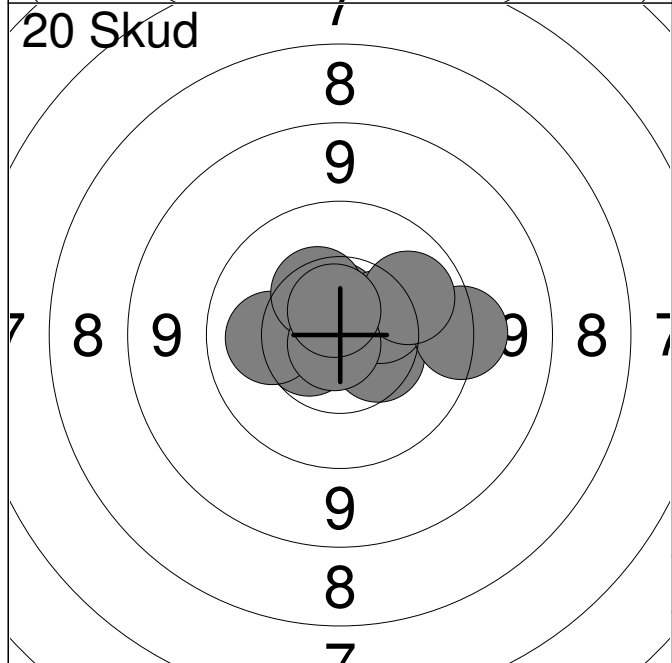

11:	10.6	↖
12:	10.6x	↑
13:	10.2	↖
14:	10.5	↘
15:	10.4	↗
16:	10.4	↗
17:	9.5	→
18:	10.1	↗
19:	10.8x	↘
20:	10.7x	↑
Serie		99.0
Total		199.0

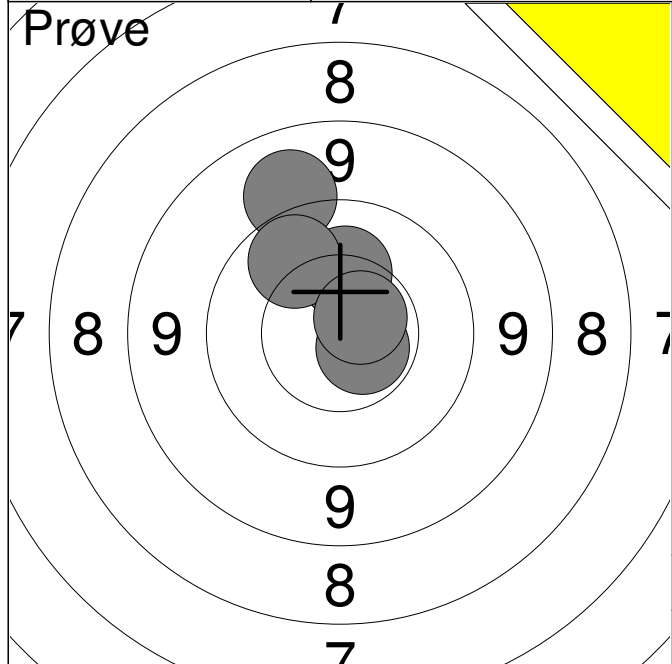

1:	10.2	↑
2:	9.2	↑
3:	10.6x	↘
4:	10.0	↑
5:	10.7x	↗
Serie		49.0
Total		0.0

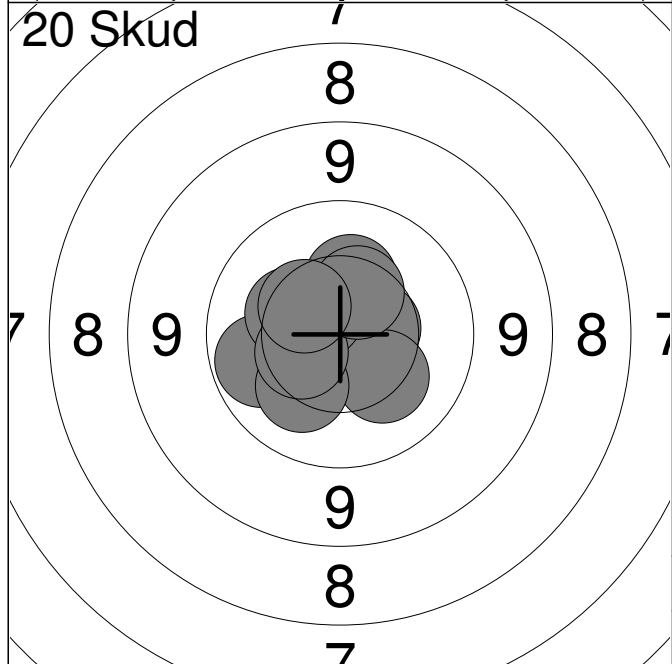

1:	10.5	→
2:	10.0	←
3:	10.2	↘
4:	10.2	↘
5:	10.3	↑
6:	10.6x	↗
7:	10.5	←
8:	10.3	↑
9:	10.4	↑
10:	10.4	↖
Serie		100.0
Total		100.0

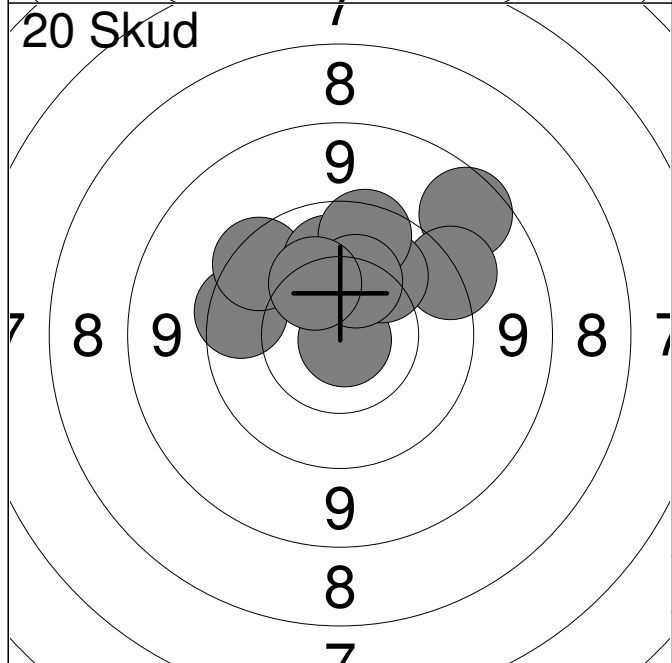

11:	8.8	↗
12:	9.4	↗
13:	9.8	←
14:	9.7	↗
15:	10.1	↑
16:	10.9x	↘
17:	10.1	↗
18:	9.8	↑
19:	10.3	↑
20:	10.3	↖
Serie		94.0
Total		194.0

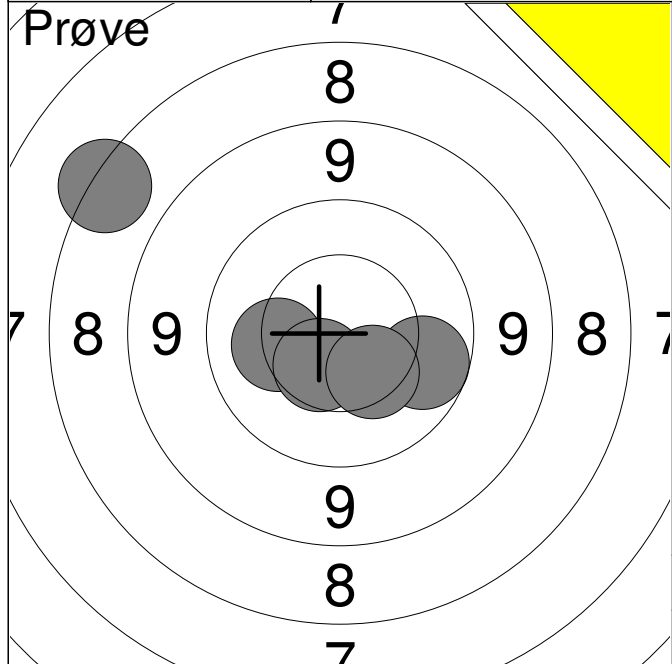

1:	7.5	↗
2:	9.9	→
3:	10.2	←
4:	10.5	↘
5:	10.4	↘
Serie		46.0
Total		0.0

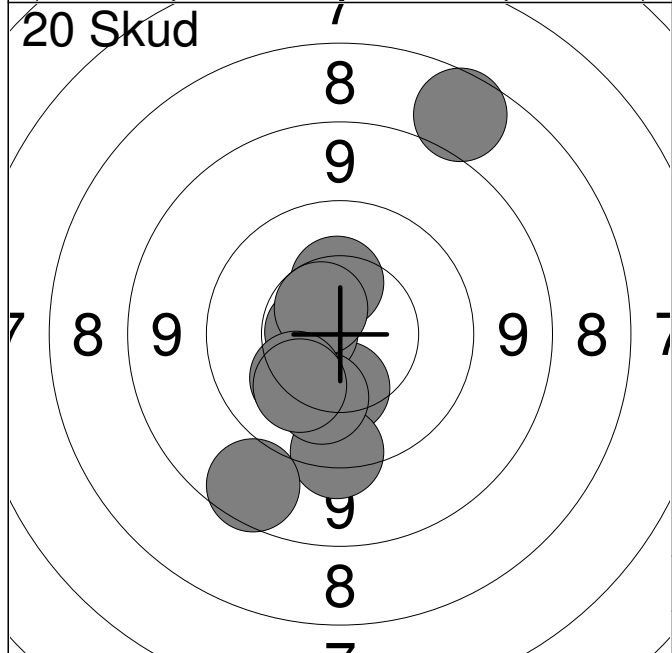

1:	7.9	↗
2:	10.4	↑
3:	10.3	↓
4:	10.6x	←
5:	10.6	↗
6:	9.6	↓
7:	10.2	↓
8:	10.2	↘
9:	10.2	↘
10:	8.8	↘
Serie		94.0
Total		94.0

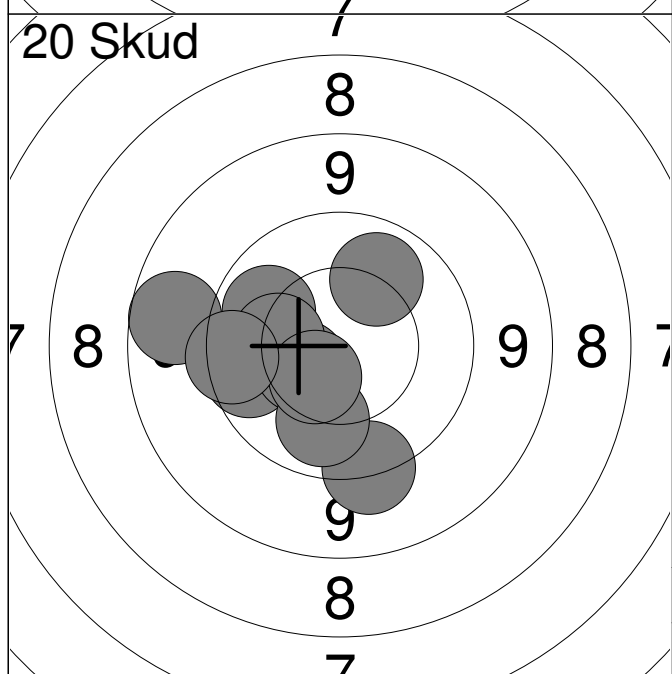

11:	9.8	←
12:	9.5	↓
13:	10.4	←
14:	10.0	↗
15:	10.1	↓
16:	10.2	←
17:	8.9	←
18:	10.5	↘
19:	9.7	←
20:	10.1	↗
Serie		95.0
Total		189.0

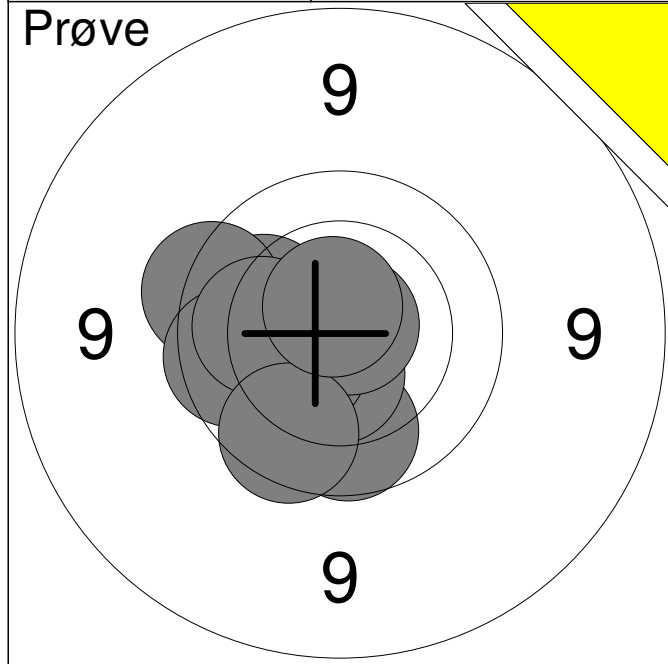

1:	9.9	↓
2:	10.1	↖
3:	9.7	↖
4:	10.5x	↓
5:	9.8	↖
6:	10.4	↖
7:	10.1	↖
8:	10.8x	↗
9:	9.8	↘
10:	10.7x	↗
Serie		96.0
Total		0.0

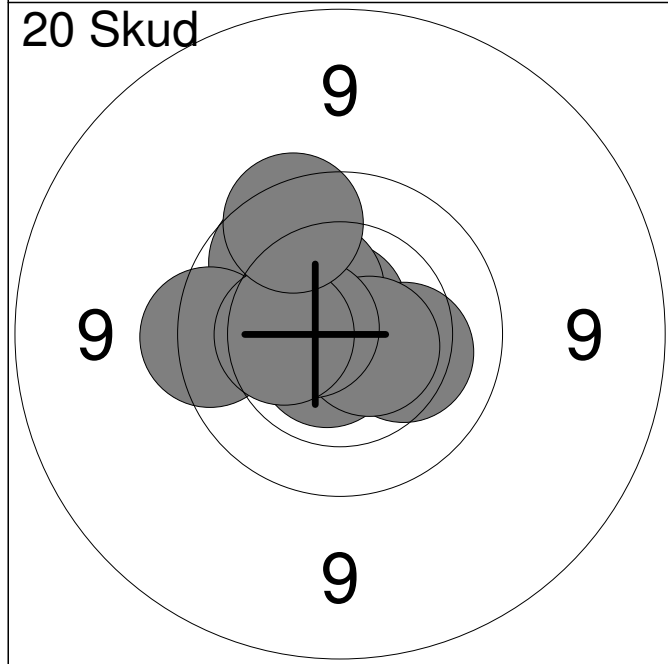

1:	10.7x	↑
2:	10.2	→
3:	9.9	↗
4:	10.7x	↘
5:	10.4	↗
6:	10.6x	↘
7:	10.6x	↖
8:	9.7	↖
9:	10.3	↖
10:	9.8	↗
Serie		97.0
Total		97.0

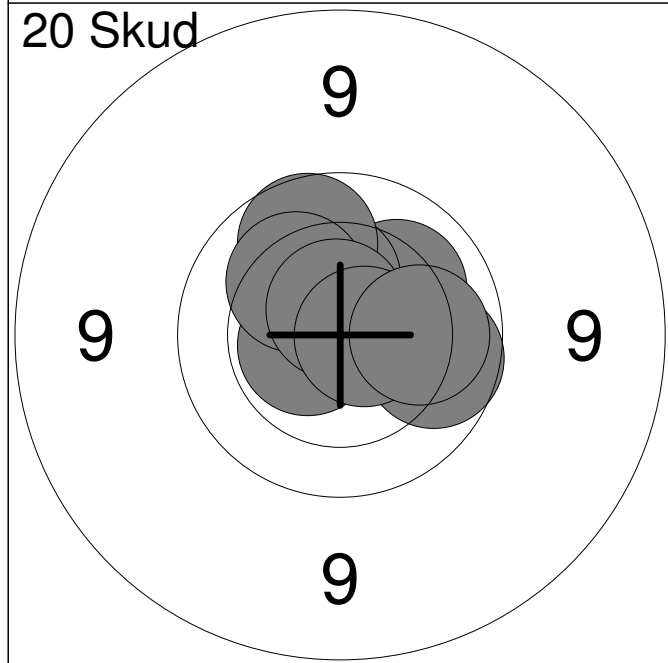

11:	10.2	→
12:	9.9	→
13:	10.2	↗
14:	10.6x	↖
15:	10.3	↑
16:	9.9	↑
17:	10.2	↗
18:	10.7x	↑
19:	10.7x	→
20:	10.1	→
Serie		98.0
Total		195.0

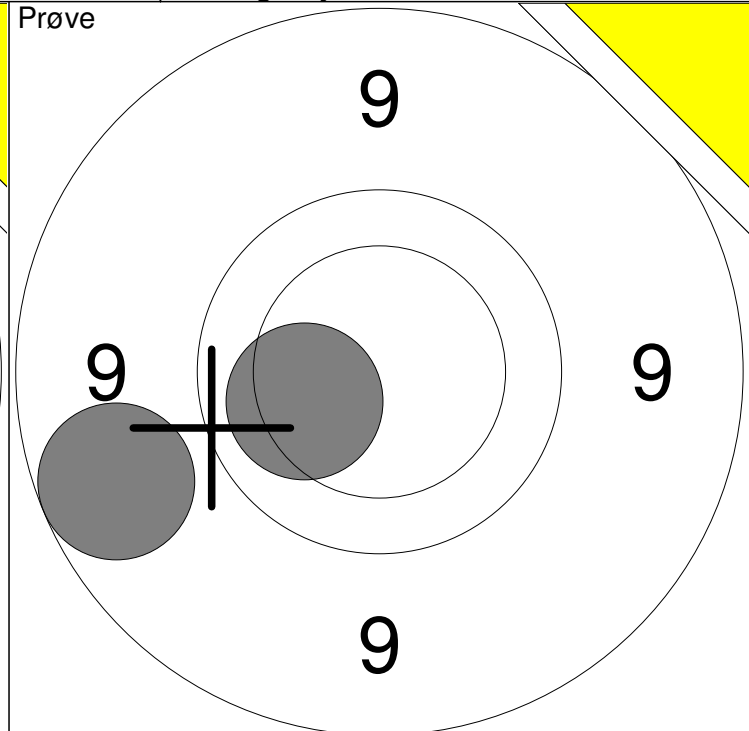
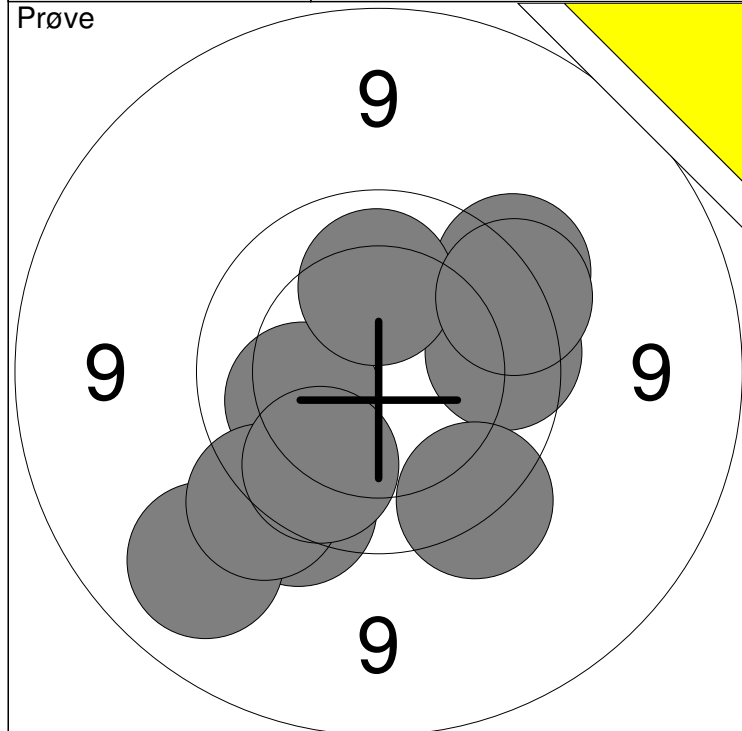

1: 9.8 →	6: 9.6 ↗	Serie	92
2: 9.7 ↘	7: 9.6 ↙		
3: 9.6 ↘	8: 10.1 ↑	Total	0
4: 9.1 ↙	9: 9.9 ↙		
5: 10.2 ←	10: 9.7 ↗		

11: 9.0 ←	Serie	19
12: 10.2 ←		
Total		0

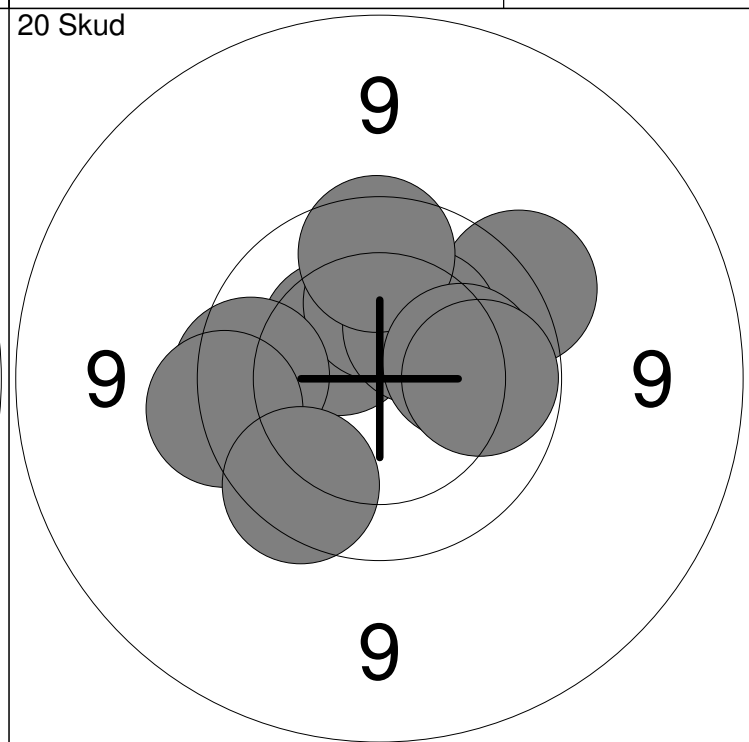
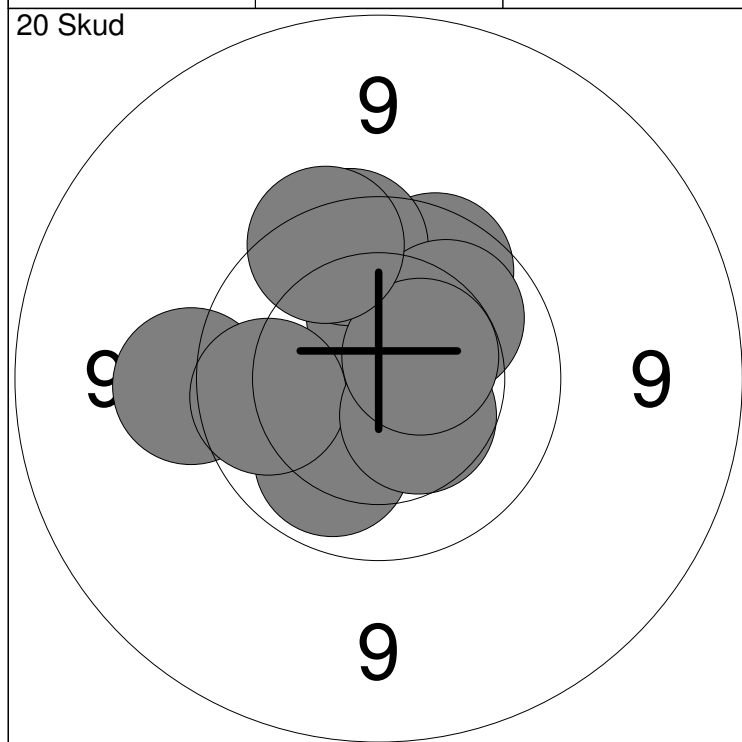

1: 10.3 ↑	6: 9.8 ↑	Serie	95
2: 9.9 ↗	7: 10.4 ↘		
3: 10.1 ↘	8: 10.1 ↗	Total	95
4: 9.5 ←	9: 10.5x ↗		
5: 9.9 ←	10: 9.7 ↑		

11: 10.4 ↖	16: 9.8 ↑	Serie	95
12: 10.2 ↑	17: 9.6 ←		
13: 9.8 ←	18: 10.1 →	Total	190
14: 9.6 ↗	19: 10.0 →		
15: 10.3 ↗	20: 9.8 ↘		

Hold 82	Skive 12	Arne Larsen	
-------------------	--------------------	--------------------	--

15m	Vilsted Skf.	MV3
-----	--------------	-----

24.10.2013	15 meter riffelstævne 2013	Aalborg Skyttekreds
------------	----------------------------	---------------------

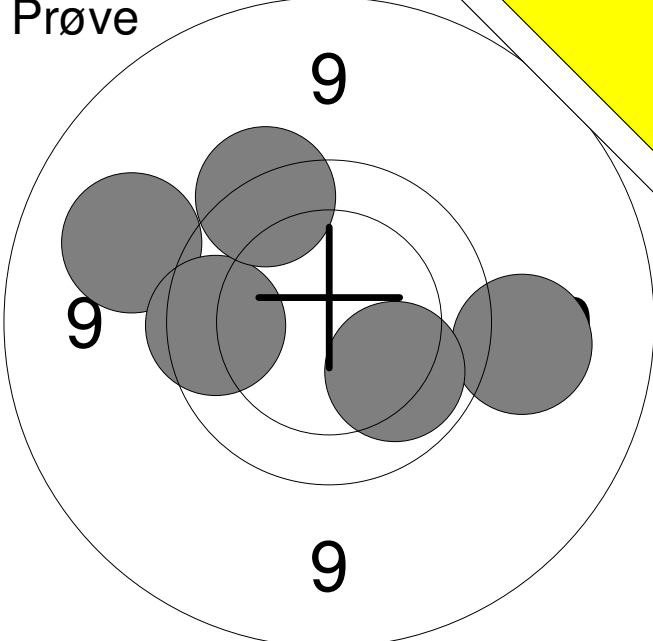
Prøve 	1: 9.3 →
	2: 10.1 ↘
	3: 9.2 ↗
	4: 9.8 ←
	5: 9.7 ↗
Serie	46.0
Total	0.0

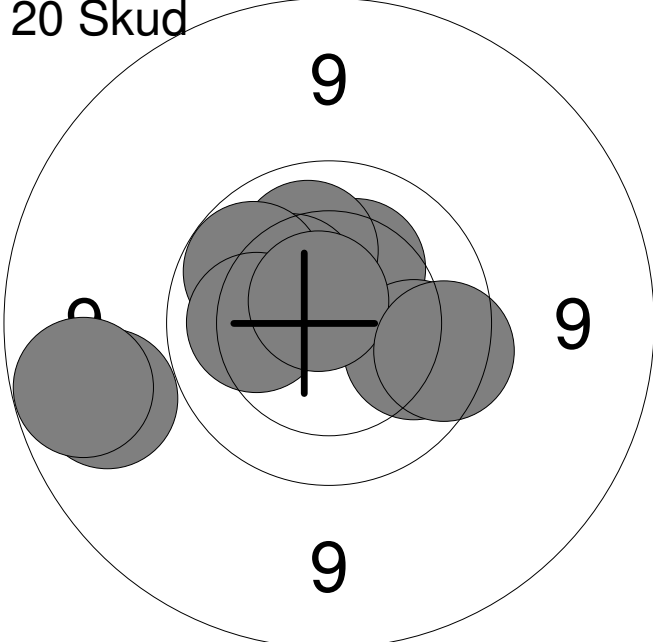
20 Skud 	1: 10.3 ↗
	2: 10.1 ↗
	3: 10.4 ↗
	4: 10.0 ↘
	5: 9.1 ←
	6: 10.0 ↗
	7: 10.2 ←
	8: 10.7x ↗
	9: 9.8 →
	10: 9.0 ←
Serie	97.0
Total	97.0

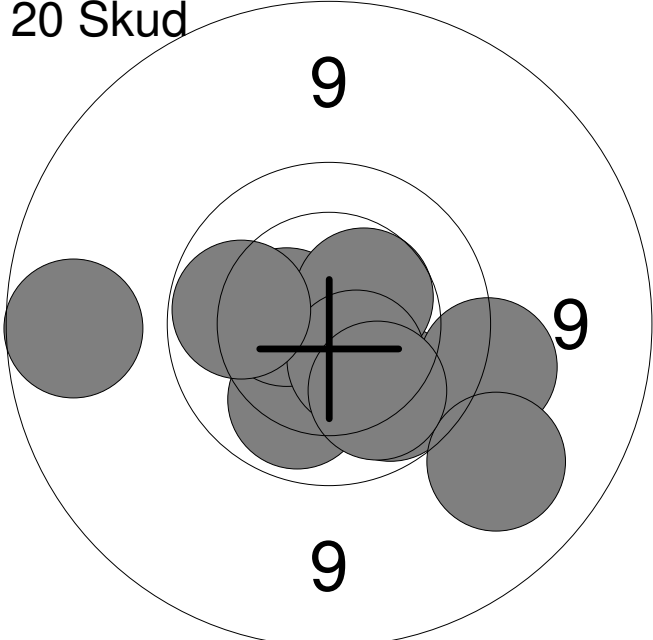
20 Skud 	11: 10.0 ↘
	12: 9.5 →
	13: 9.2 ↘
	14: 10.1 ↘
	15: 10.5 ←
	16: 8.9 ←
	17: 10.5 ↗
	18: 10.5 ↘
	19: 10.0 ←
	20: 10.1 ↘
Serie	96.0
Total	193.0

Hold 83	Skive 1	Henrik Hyldahl Jensen	
-------------------	-------------------	------------------------------	--

15m	Aalborg Skyttekreds	ÅK1	
-----	---------------------	-----	--

24.10.2013	15 meter riffelstævne 2013	Aalborg Skyttekreds	
------------	----------------------------	---------------------	--

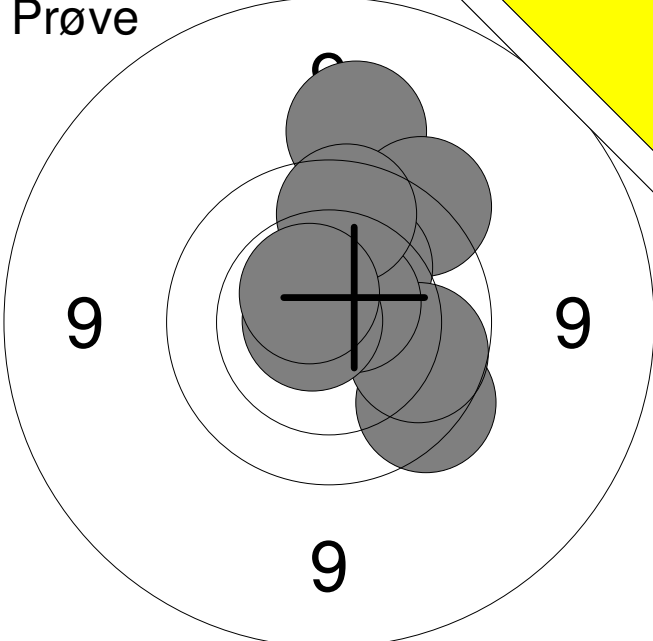
Prøve 	1:	9.3	↑
	2:	9.6	↗
	3:	9.7	↘
	4:	10.5x	↗
	5:	10.3	↗
	6:	9.9	→
	7:	10.6x	↗
	8:	10.8x	←
	9:	9.8	↑
	10:	10.6x	↗
	Serie		95.0
Total		0.0	

20 Skud 	1:	10.4	↗
	2:	10.9x	↓
	3:	10.0	↖
	4:	10.6x	↗
	5:	10.6x	←
	6:	10.4	↗
	7:	10.5	→
	8:	10.2	↑
	9:	10.0	↗
	10:	10.4	↑
	Serie		100.0
Total		100.0	

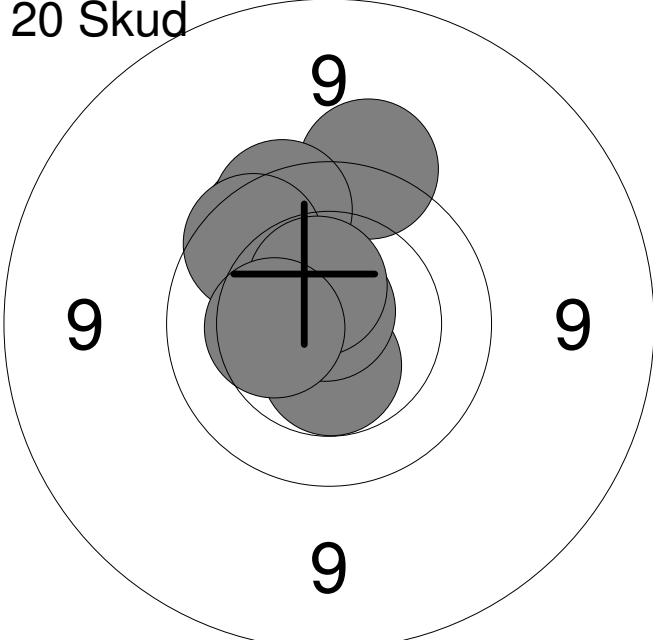
20 Skud 	11:	10.2	↖
	12:	9.5	↑
	13:	9.8	↖
	14:	9.8	↖
	15:	10.3	↗
	16:	9.8	↗
	17:	10.5x	↓
	18:	10.8x	↑
	19:	10.5x	↖
	20:	10.4	←
	Serie		96.0
Total		196.0	

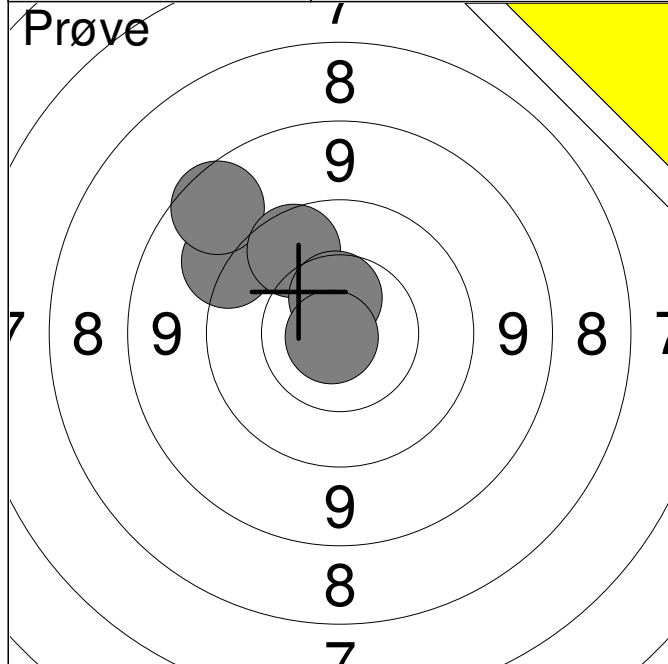

1:	9.4	↗
2:	8.8	↗
3:	9.8	↗
4:	10.5	↑
5:	10.8x	↖
Serie	46.0	
Total	0.0	

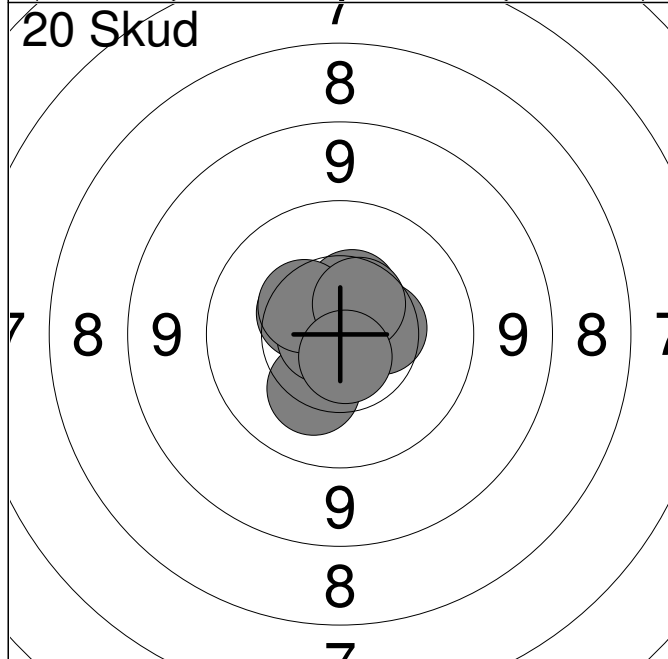

1:	10.5	↗
2:	10.5	↗
3:	10.6	↗
4:	10.3	↘
5:	10.8x	↖
6:	10.5	→
7:	10.5	↑
8:	10.4	↗
9:	10.5	↗
10:	10.7x	↘
Serie	100.0	
Total	100.0	

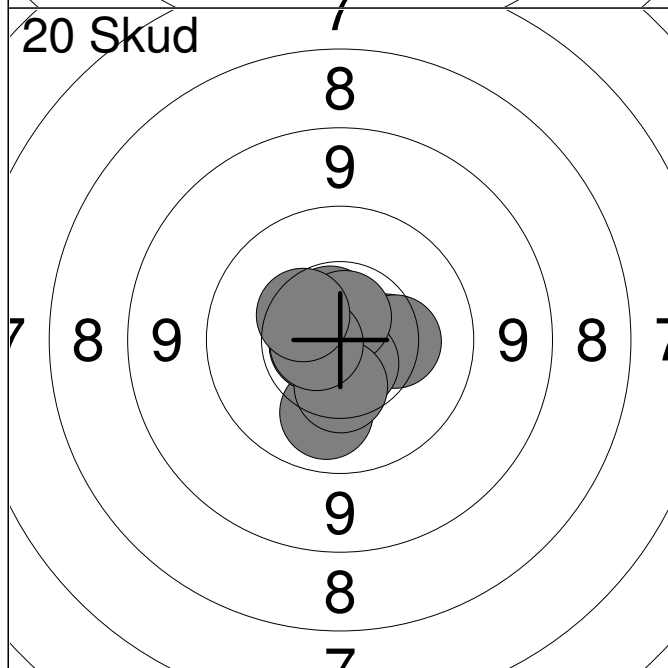

11:	10.4	→
12:	10.3	→
13:	10.6x	↑
14:	10.6x	↘
15:	10.7x	↑
16:	10.1	↘
17:	10.7x	↖
18:	10.4	↘
19:	10.7x	↖
20:	10.4	↗
Serie	100.0	
Total	200.0	

Hold 83	Skive 3	Benjamin Schou Thomsen	
-------------------	-------------------	-------------------------------	--

15m	Hobro Egnens Skytteforening	MÅ1
-----	-----------------------------	-----

24.10.2013	15 meter riffelstævne 2013	Aalborg Skyttekreds
------------	----------------------------	---------------------

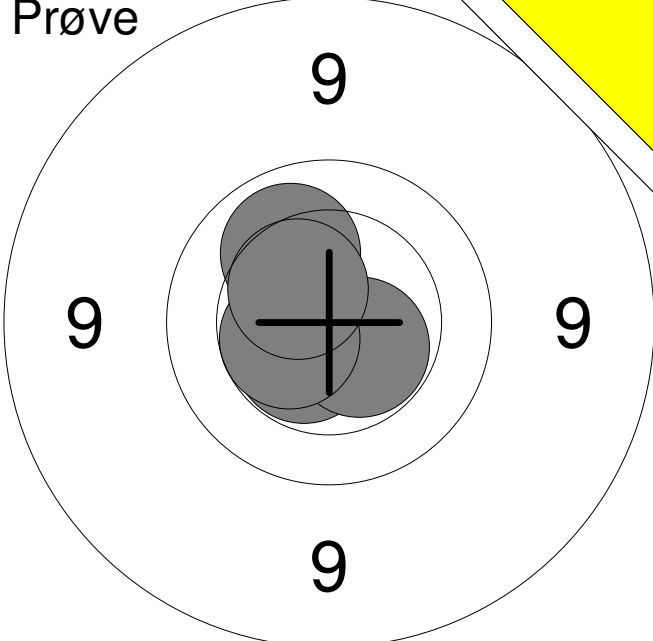
Prøve 	1: 10.5x ↙
	2: 10.1 ↗
	3: 10.5x ↘
	4: 10.5 ↖
	5: 10.5 ↗
Serie	50.0
Total	0.0

20 Skud 	1: 10.6x ↖
	2: 10.5 ↘
	3: 10.3 ↑
	4: 10.6x →
	5: 9.9 →
	6: 9.8 ↗
	7: 10.8x ↗
	8: 10.6x ←
	9: 10.1 ↗
	10: 10.1 ↗
Serie	98.0
Total	98.0

20 Skud 	11: 10.4 ↗
	12: 10.5 ↗
	13: 10.7x →
	14: 9.9 →
	15: 9.8 ↗
	16: 9.7 ←
	17: 10.3 ↖
	18: 10.4 ↘
	19: 10.3 →
	20: 10.3 →
Serie	97.0
Total	195.0

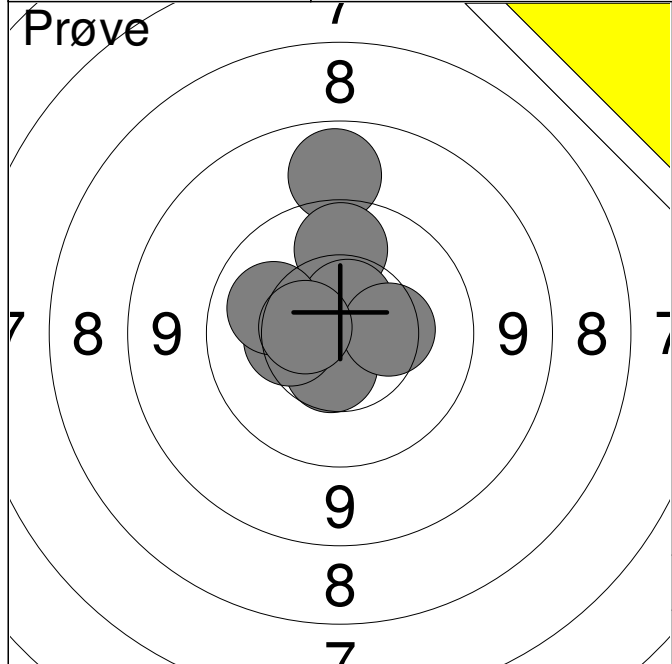

1:	9.0	↑
2:	10.0	↑
3:	10.6x	↑
4:	10.6	↓
5:	10.4	←
6:	10.1	↖
7:	10.4	→
8:	10.5	←
Serie		79.0
Total		0.0

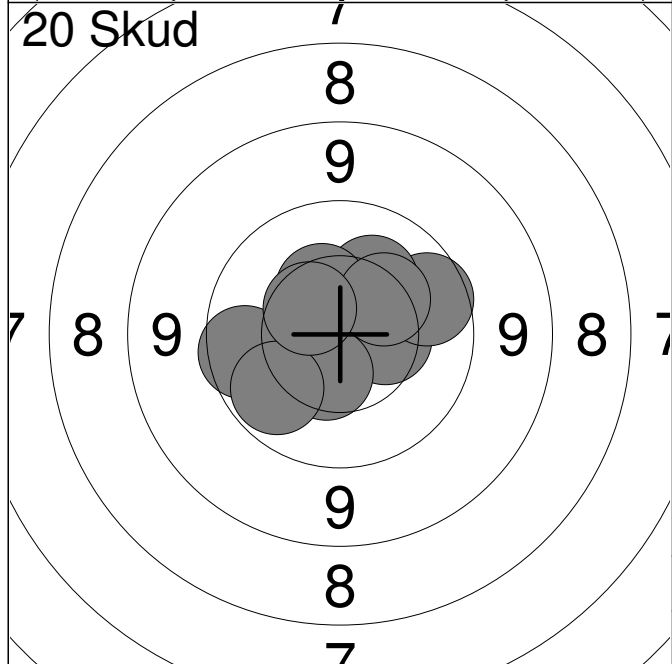

1:	10.4	→
2:	9.9	→
3:	10.2	↗
4:	9.8	←
5:	10.6	↗
6:	10.5	↓
7:	10.4	↑
8:	10.0	↖
9:	10.3	↗
10:	10.5	↗
Serie		98.0
Total		98.0

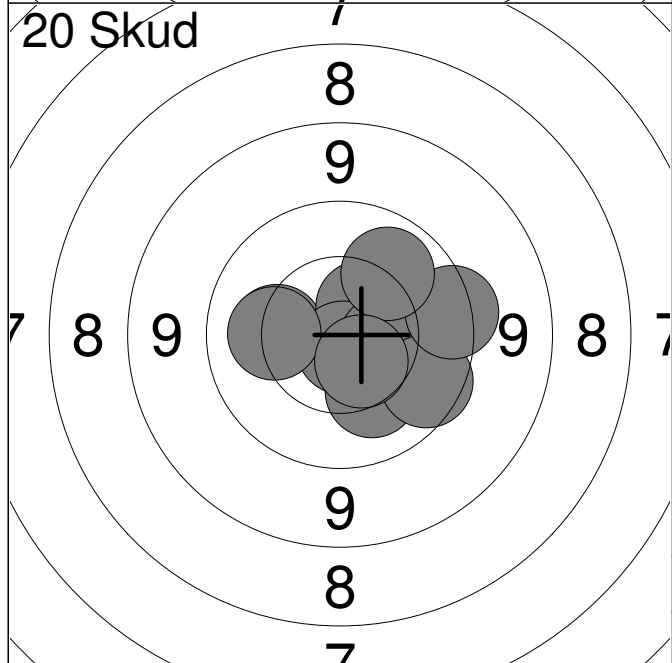

11:	10.2	←
12:	10.5	↗
13:	10.2	↓
14:	10.8x	↓
15:	10.4	→
16:	9.8	↘
17:	9.6	→
18:	10.2	←
19:	10.1	↗
20:	10.6	↓
Serie		98.0
Total		196.0

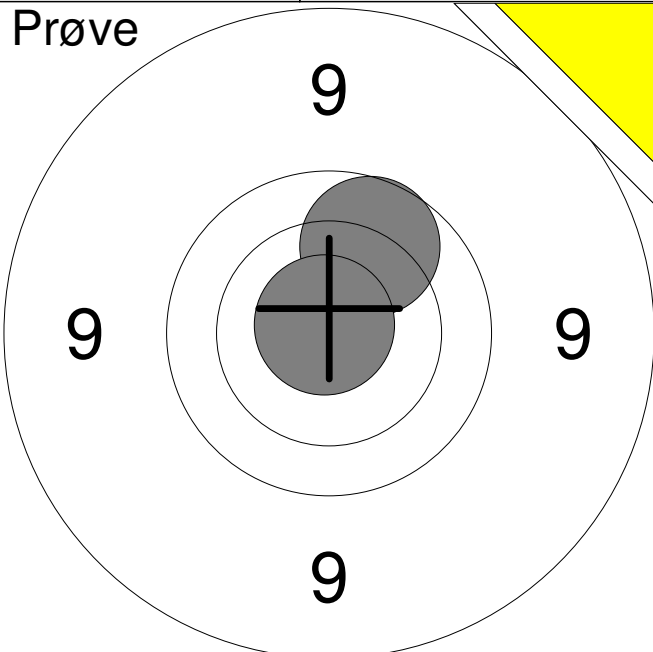
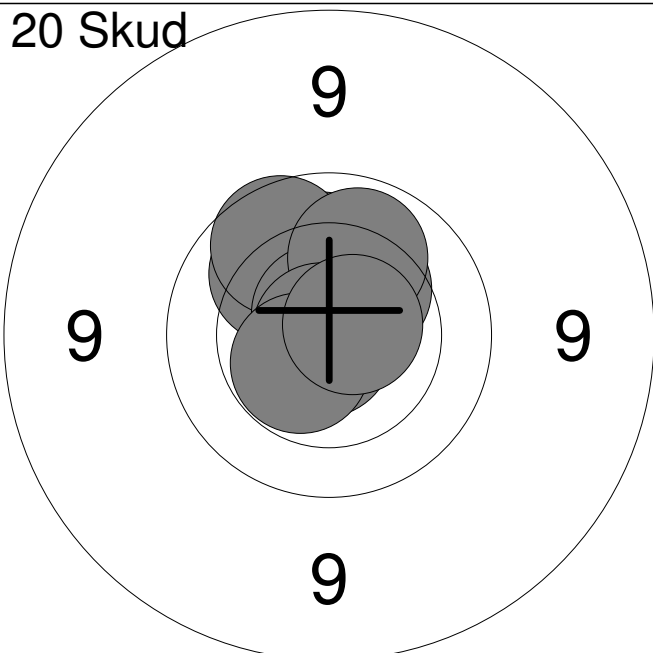
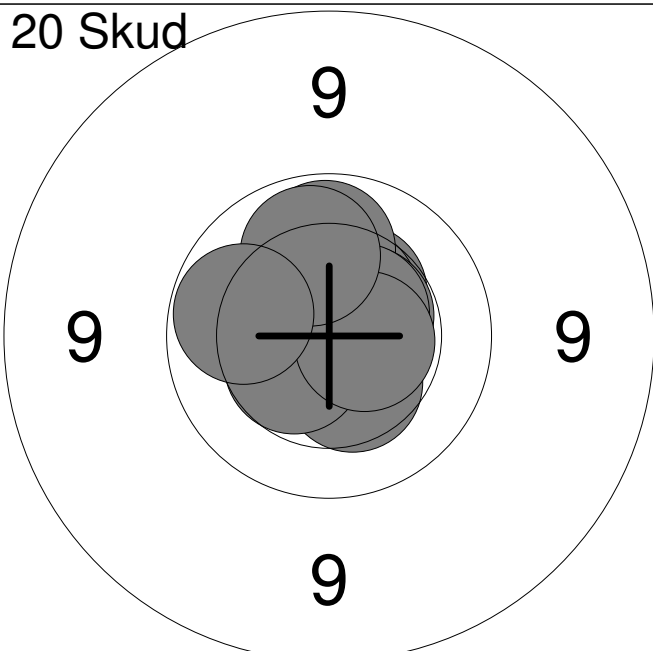
Hold	Skive	Karsten Abildgaard		
83	5	Hobro Egnens Skytteforening		MÅ1
24.10.2013	15 meter riffelstævne 2013		Aalborg Skyttekreds	
Prøve			1: 9.9 ↗	
			2: 10.8x ↖	
			Serie 19.0	
Total 0.0				
20 Skud			1: 10.3 ↗	
			2: 10.2 ↑	
			3: 10.1 ↖	
			4: 9.9 ↑	
			5: 10.8x ↘	
			6: 10.7x ↑	
			7: 10.1 ↑	
			8: 10.9x ↖	
			9: 10.5x ↘	
			10: 10.7x →	
Serie 99.0				
Total 99.0				
20 Skud			11: 10.4 ↗	
			12: 10.5 ↑	
			13: 10.0 ↑	
			14: 10.5x ↗	
			15: 10.5x ↗	
			16: 10.4 ↘	
			17: 10.5 ↖	
			18: 10.6x →	
			19: 10.1 ↑	
			20: 10.0 ↖	
Serie 100.0				
Total 199.0				

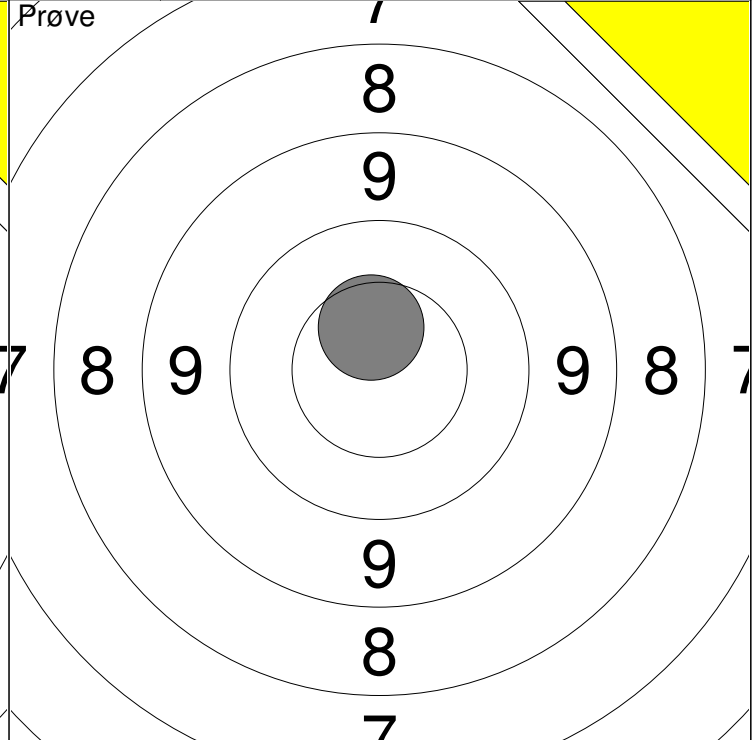
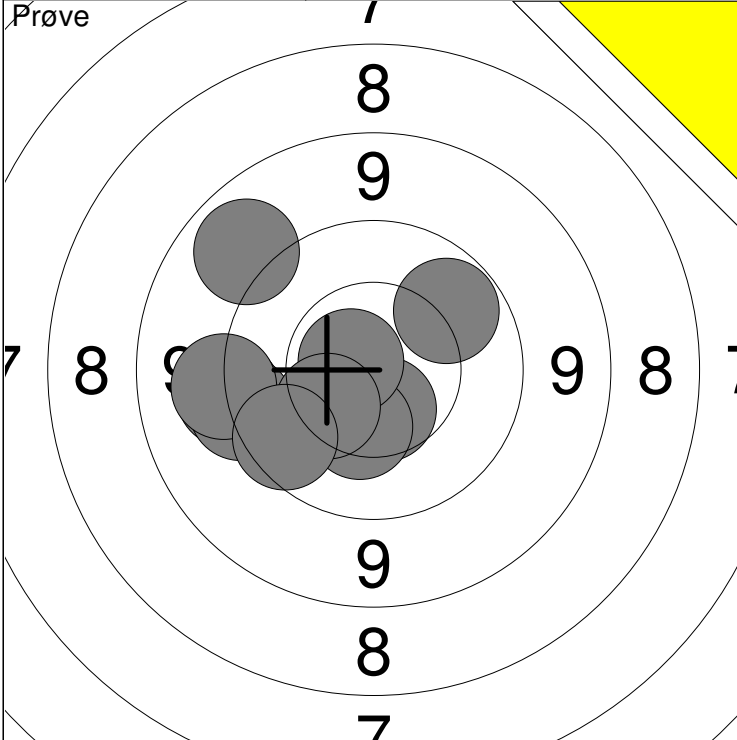

1: 9.4 ←	6: 10.3 ↓	Serie 95
2: 9.1 ↗	7: 10.7x ↖	
3: 10.5 ↓	8: 10.3 ↙	Total 0
4: 9.5 ←	9: 9.8 ↙	
5: 9.3 ←	10: 10.0 ↗	

11: 10.5 ↑	Serie 10
Total 0	

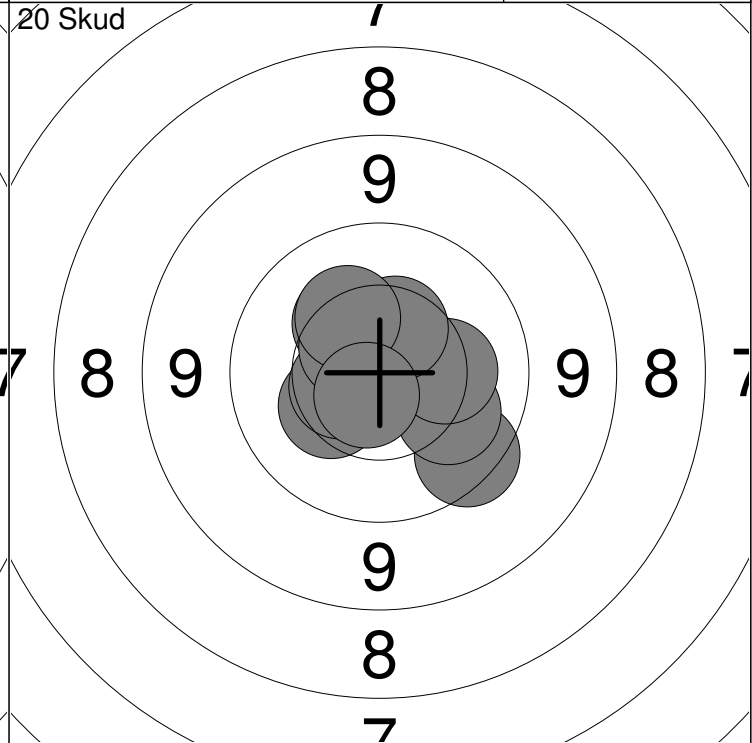
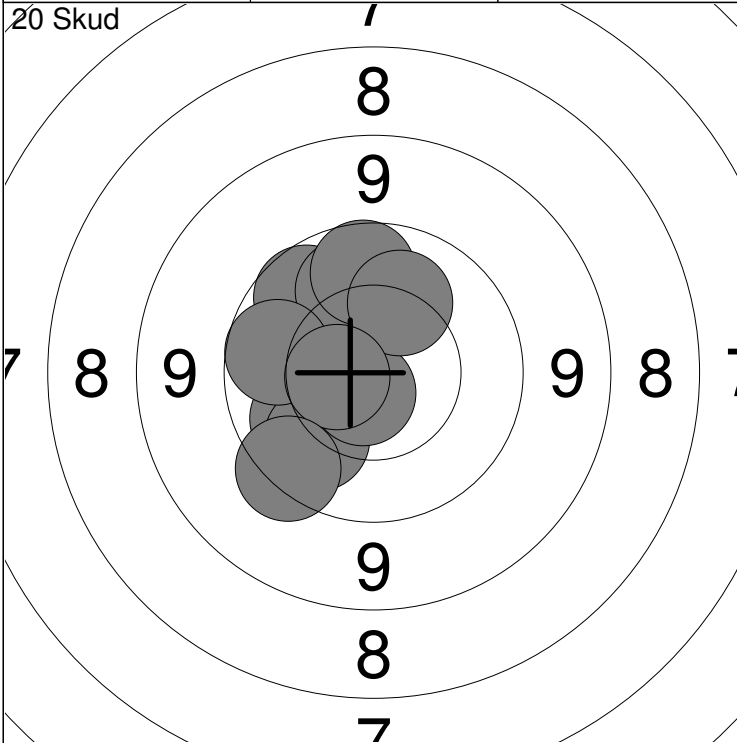

1: 9.9 ↗	6: 9.9 ←	Serie 96
2: 10.1 ↖	7: 9.9 ↑	
3: 10.0 ↙	8: 10.2 ↗	Total 96
4: 10.7x ↘	9: 10.6 ←	
5: 10.1 ↗	10: 9.6 ↘	

11: 10.3 ↖	16: 10.3 →	Serie 99
12: 9.7 ↘	17: 10.6 ↗	
13: 10.1 ↘	18: 10.5 ↗	Total 195
14: 10.3 ↗	19: 10.3 ↗	
15: 10.5 ←	20: 10.7x ↘	

Hold 83	Skive 7	Christian Jensen	
-------------------	-------------------	-------------------------	--

15m	Ribe Skyttekreds	MÅ1
-----	------------------	-----

24.10.2013	15 meter riffelstævne 2013	Aalborg Skyttekreds
------------	----------------------------	---------------------

Prøve 	1: 10.1	↑
	2: 10.8x	↓
	3: 10.8x	↗
	4: 10.7x	↓
	Serie	40.0
Total	0.0	

20 Skud 	1: 10.0	↓
	2: 10.3	↓
	3: 10.8x	↘
	4: 10.3	←
	5: 10.5x	↓
	6: 10.2	↘
	7: 10.5x	↓
	8: 10.3	↑
	9: 10.6x	↙
	10: 10.1	→
	Serie	100.0
Total	100.0	

20 Skud 	11: 10.8x	↑
	12: 10.6x	←
	13: 10.8x	←
	14: 10.9x	↘
	15: 10.6x	↗
	16: 10.3	←
	17: 10.5x	↗
	18: 10.5x	↘
	19: 10.5x	↗
	20: 10.5	↙
	Serie	100.0
Total	200.0	

Hold 83	Skive 9	Arne Schiønning	
-------------------	-------------------	------------------------	--

15m	Aalborg Skyttekreds	MV1	
-----	---------------------	-----	--

24.10.2013	15 meter riffelstævne 2013	Aalborg Skyttekreds	
------------	----------------------------	---------------------	--

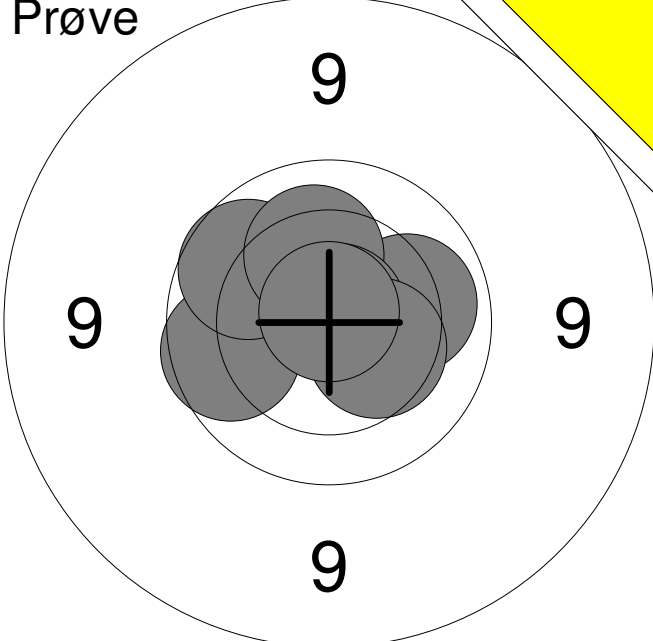
Prøve 	1: 9.9 ←
	2: 9.9 ↗
	3: 10.1 →
	4: 10.2 ↑
	5: 10.8x ↗
	6: 10.4 ↘
	7: 10.8x ↑
Serie 68.0	
Total 0.0	

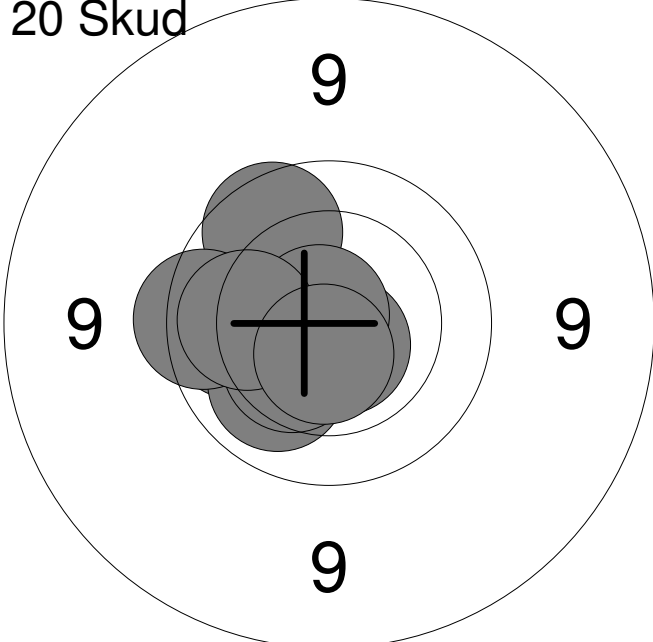
20 Skud 	1: 10.6x ←
	2: 10.7x ↘
	3: 9.9 ↗
	4: 10.8x ↗
	5: 9.9 ←
	6: 10.1 ↘
	7: 9.7 ←
	8: 10.4 ↘
	9: 10.1 ←
	10: 10.6x ↘
Serie 97.0	
Total 97.0	

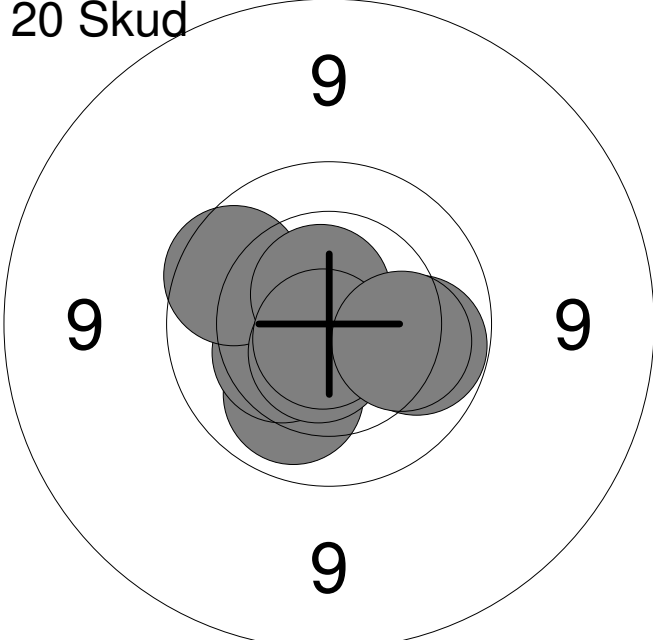
20 Skud 	11: 10.1 ↘
	12: 10.0 →
	13: 10.7x ↘
	14: 10.4 ←
	15: 10.8x ←
	16: 9.9 ↗
	17: 10.6x ↘
	18: 10.6x ↑
	19: 10.8x ↘
	20: 10.1 →
Serie 99.0	
Total 196.0	

Hold 83	Skive 10	Erik Skovmand	
15m	Viborg Skytteforening		1
24.10.2013	15 meter riffelstævne 2013	Aalborg Skyttekreds	
Prøve		1: 10.7x	➔
		2: 10.7x	➔
		3: 9.9	➔
		4: 10.7x	➔
		5: 10.8x	➔
		Serie	49.0
		Total	0.0
20 Skud		1: 9.6	➔
		2: 10.0	➔
		3: 10.5	➔
		4: 9.8	➔
		5: 10.3	➔
		6: 10.2	➔
		7: 10.6x	➔
		8: 10.0	➔
		9: 10.4	➔
		10: 10.1	➔
		Serie	98.0
		Total	98.0
20 Skud		11: 10.5x	➔
		12: 10.4	➔
		13: 10.0	➔
		14: 9.9	➔
		15: 9.6	➔
		16: 10.3	➔
		17: 10.3	➔
		18: 10.8x	➔
		19: 10.7x	➔
		20: 10.1	➔
		Serie	98.0
		Total	196.0

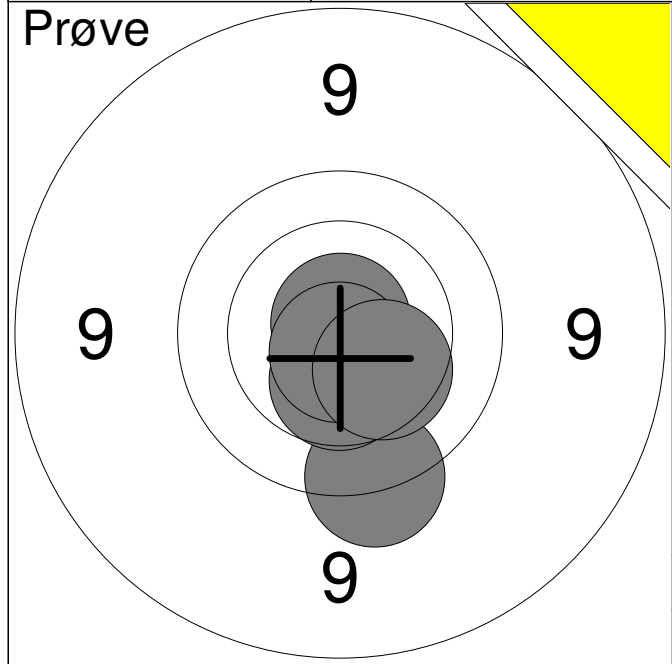

1:	9.6	↓
2:	10.4	↓
3:	10.8x	↑
4:	10.7x	↓
5:	10.4	↓
Serie		49.0
Total		0.0

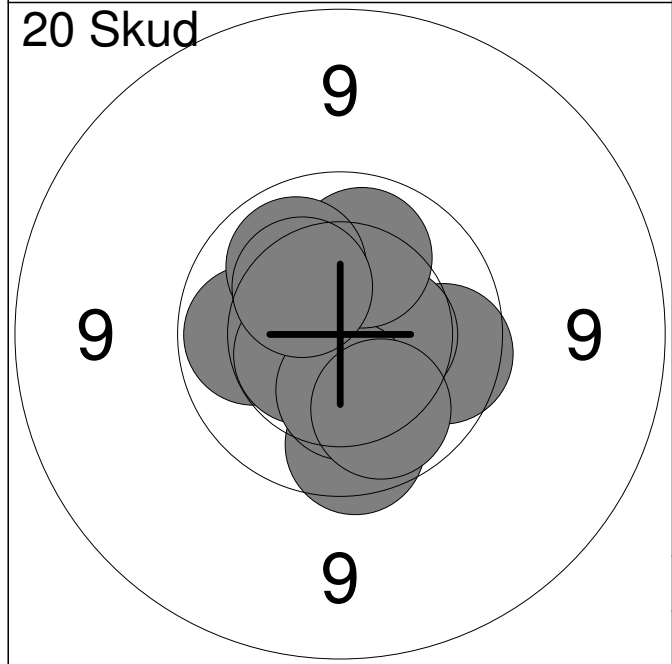

1:	9.9	→
2:	10.0	←
3:	10.4	→
4:	10.5x	←
5:	9.8	↓
6:	10.3	↓
7:	10.1	↑
8:	10.1	↗
9:	10.3	↗
10:	10.0	↓
Serie		98.0
Total		98.0

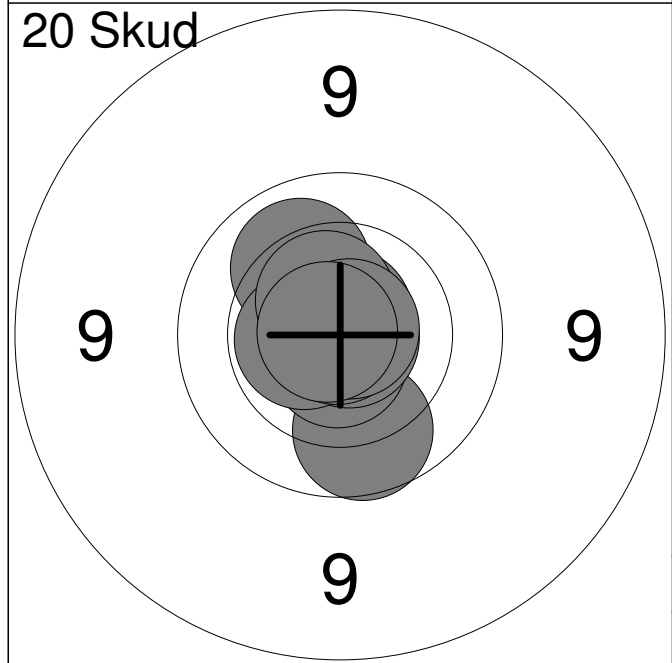

11:	9.9	↓
12:	10.7x	↓
13:	10.1	↗
14:	10.8x	→
15:	10.6x	←
16:	10.8x	↑
17:	10.6x	↗
18:	10.9x	←
19:	10.8x	↗
20:	10.8x	←
Serie		99.0
Total		197.0

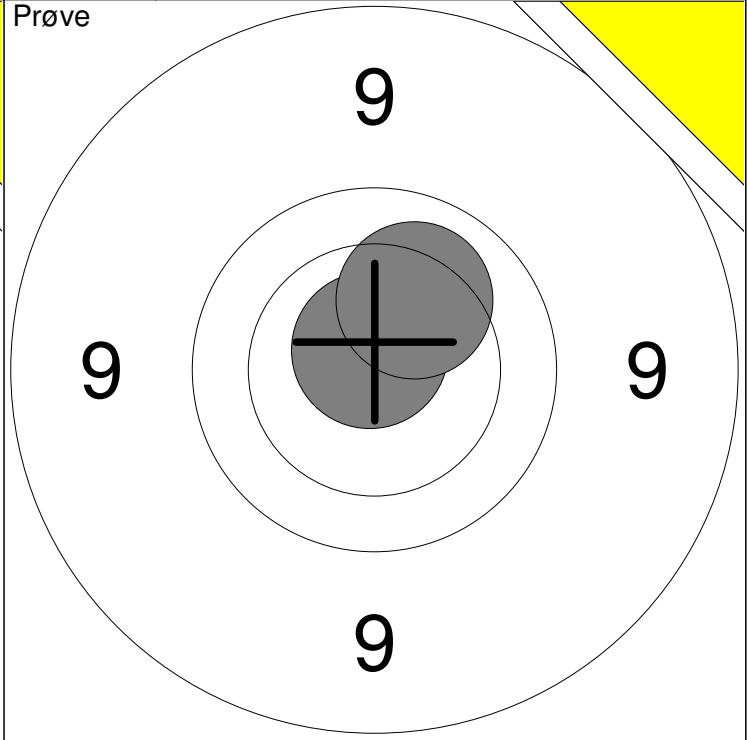
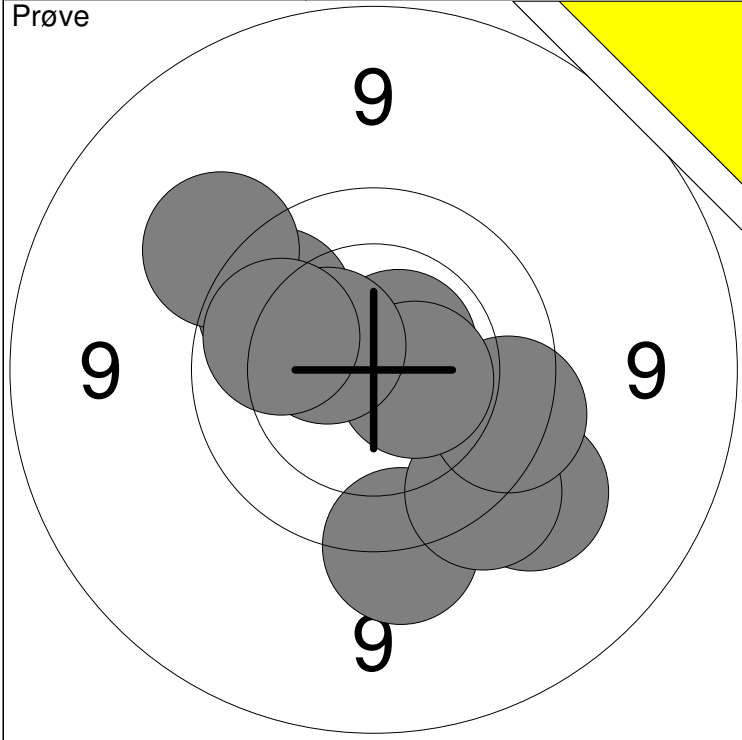

1: 9.5 ↓	6: 10.5x →	Serie	94
2: 9.4 ↓	7: 9.9 ↗		
3: 9.6 ↓	8: 9.5 ↗	Total	0
4: 9.7 →	9: 10.4 ↗		
5: 10.6x ↗	10: 10.0 ↖		

11: 10.8x ↑	Serie	20
12: 10.2 ↗		
Total		0

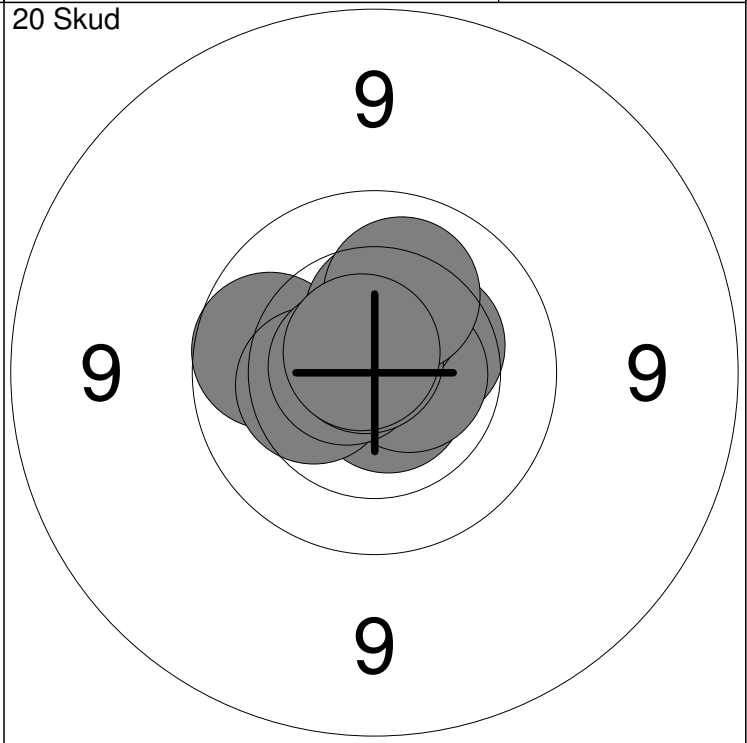
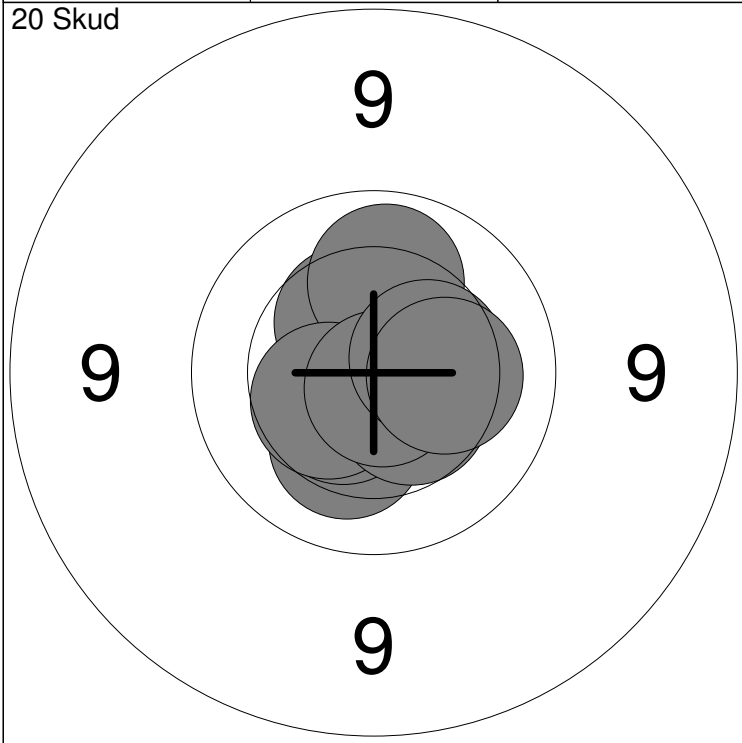

1: 10.6x ↗	6: 10.4 ←	Serie	100
2: 10.4 ↗	7: 10.5 ↓		
3: 10.1 ↑	8: 10.8x ↓	Total	100
4: 10.2 ↓	9: 10.4 →		
5: 10.5x ↖	10: 10.3 →		

11: 9.9 ←	16: 10.4 ↑	Serie	99
12: 10.4 →	17: 10.7x ←		
13: 10.7x ↓	18: 10.8x ↗	Total	199
14: 10.4 ←	19: 10.2 ↑		
15: 10.6x →	20: 10.7x ↖		

Hold 84	Skive 1	Christian Jensen
-------------------	-------------------	-------------------------

15m	Ribe Skyttekreds	ÅK1
-----	------------------	-----

24.10.2013	15 meter riffelstævne 2013	Aalborg Skyttekreds
------------	----------------------------	---------------------

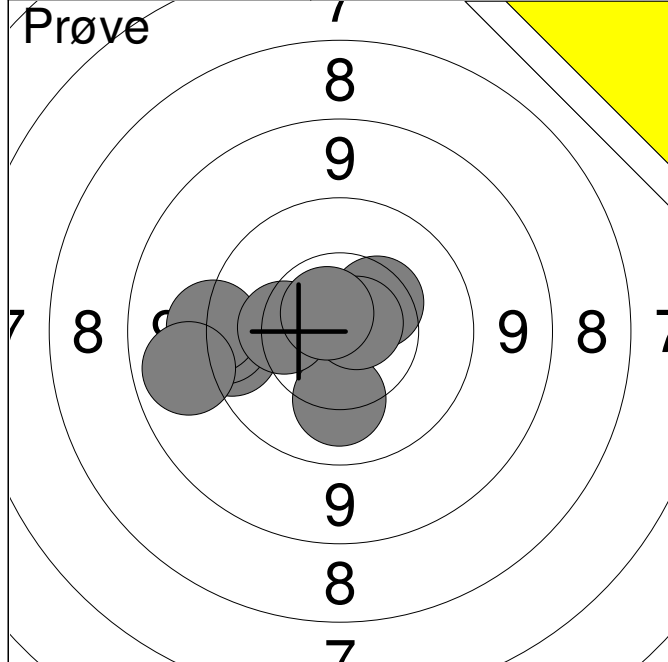

1:	9.7	←
2:	9.6	←
3:	9.4	←
4:	9.1	←
5:	10.2	↓
6:	10.4	↗
7:	10.7x	↗
8:	10.3	←
9:	10.7x	↗
Serie	86.0	
Total	0.0	

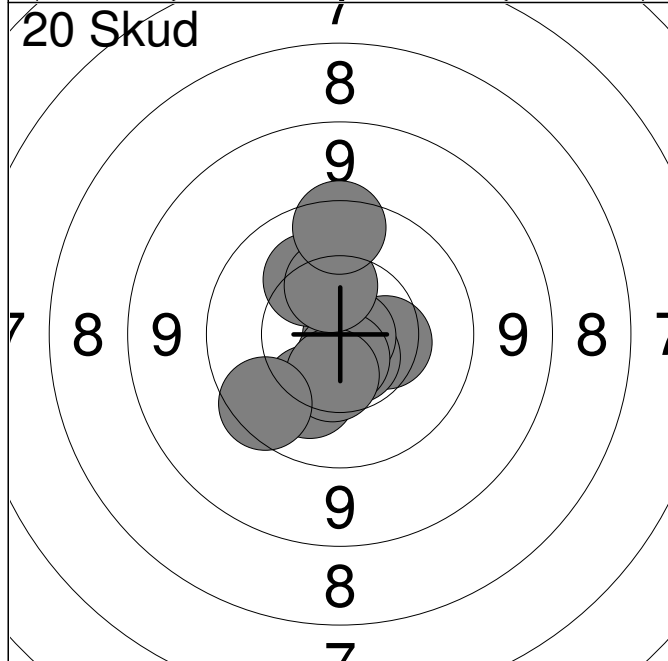

1:	10.4	→
2:	10.6x	↓
3:	10.2	↓
4:	10.8x	→
5:	10.7x	↓
6:	10.5	↓
7:	10.2	↗
8:	9.7	←
9:	10.4	↑
10:	9.7	↑
Serie	98.0	
Total	98.0	

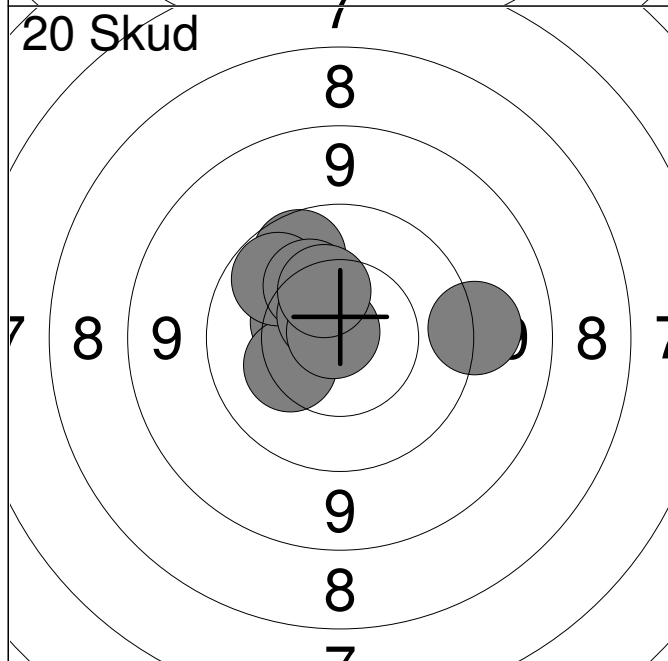

11:	10.4	↖
12:	10.6	↗
13:	9.9	↗
14:	10.3	←
15:	10.0	↗
16:	10.2	↗
17:	10.6x	↗
18:	10.8x	↗
19:	9.3	→
20:	10.4	↖
Serie	98.0	
Total	196.0	

Hold 84	Skive 2	Jens Arne Abildgaard	
-------------------	-------------------	-----------------------------	--

15m	Hobro Egnens Skytteforening	ÅK1	
-----	-----------------------------	-----	--

24.10.2013	15 meter riffelstævne 2013	Aalborg Skyttekreds	
------------	----------------------------	---------------------	--

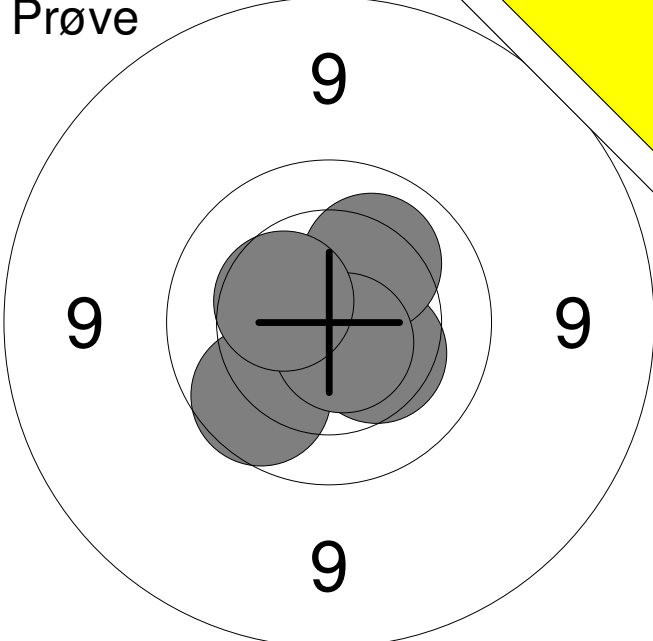
Prøve 	1: 9.9 ↙
	2: 10.3 ↘
	3: 10.2 ↗
	4: 10.7x ↘
	5: 10.4 ↗
Serie	49.0
Total	0.0

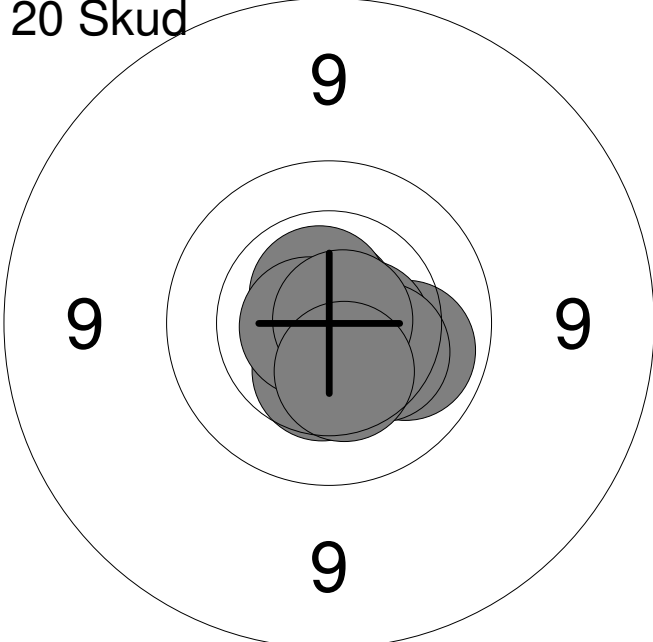
20 Skud 	1: 10.8x ↑
	2: 10.6x ↗
	3: 10.8x ↘
	4: 10.1 ↘
	5: 10.4 ↘
	6: 10.6x ↗
	7: 10.3 ↘
	8: 10.7x ←
	9: 10.8x →
	10: 10.4 ↘
Serie	100.0
Total	100.0

20 Skud 	11: 10.2 ↗
	12: 10.0 ↘
	13: 9.8 →
	14: 10.1 ↘
	15: 10.5 ↘
	16: 10.2 ↘
	17: 10.5 ↗
	18: 10.7x →
	19: 10.6x ↘
	20: 10.3 ↗
Serie	99.0
Total	199.0

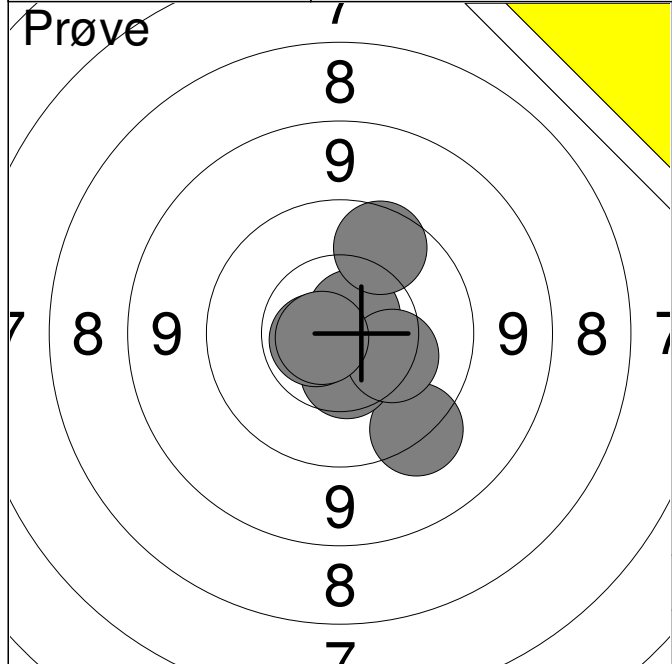

1:	9.5	↘
2:	10.7x	↗
3:	10.5	↘
4:	10.3	↘
5:	10.7x	↙
6:	9.8	↗
7:	10.7x	↙
Serie		68.0
Total		0.0

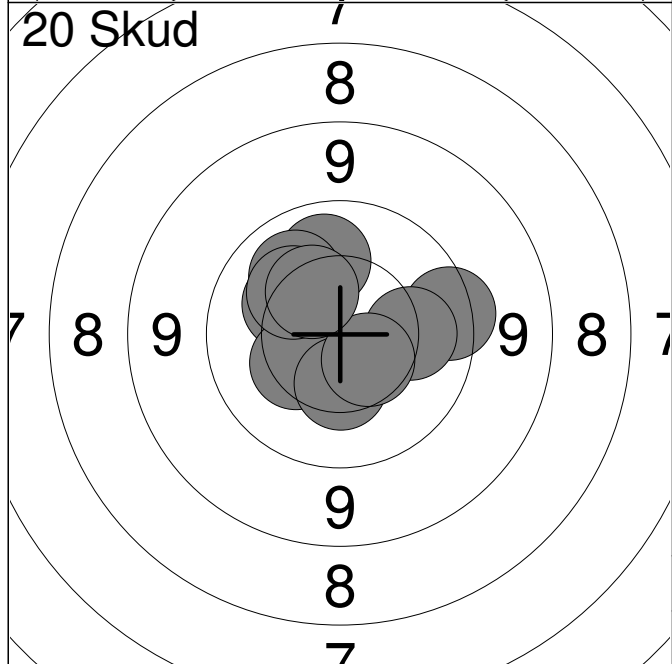

1:	10.1	↗
2:	10.3	↗
3:	10.3	↙
4:	9.6	→
5:	10.1	→
6:	10.1	↗
7:	10.4	↘
8:	10.2	↗
9:	10.5	↘
10:	10.4	↗
Serie		99.0
Total		99.0

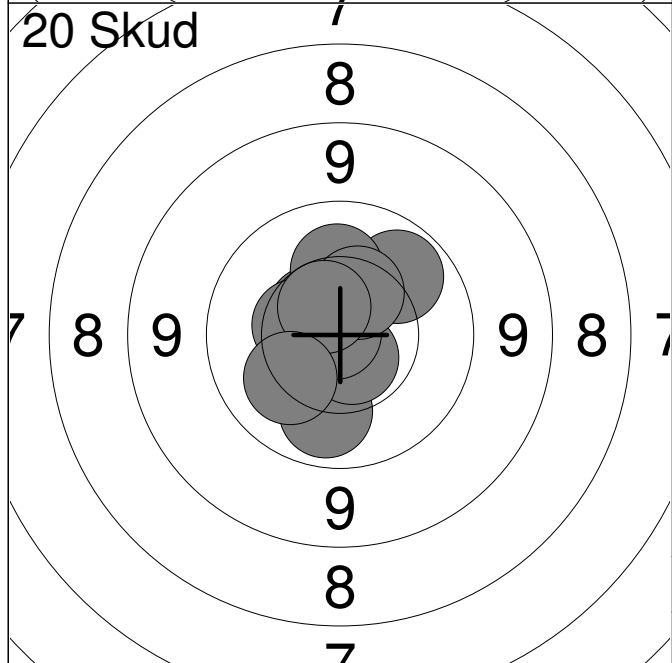

11:	10.1	↘
12:	10.6	↗
13:	10.5	↙
14:	10.0	↗
15:	10.7x	↘
16:	10.2	↗
17:	10.9x	↗
18:	10.4	↗
19:	10.6	↗
20:	10.2	↙
Serie		100.0
Total		199.0

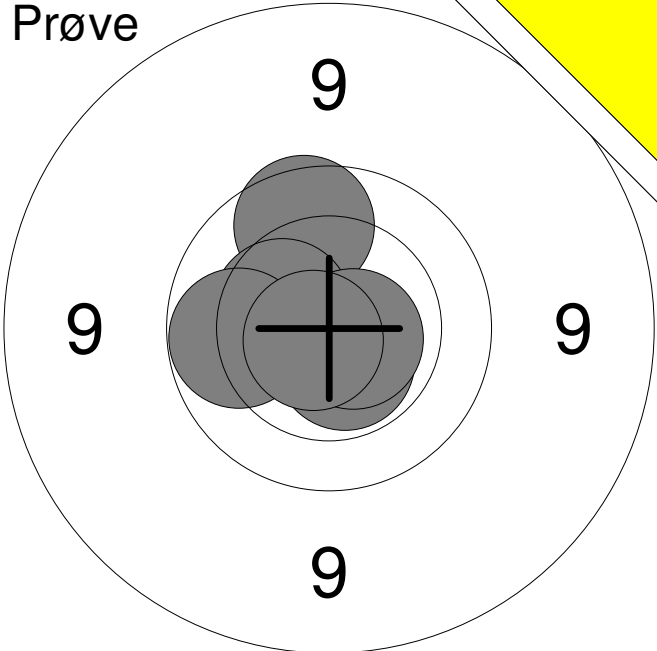
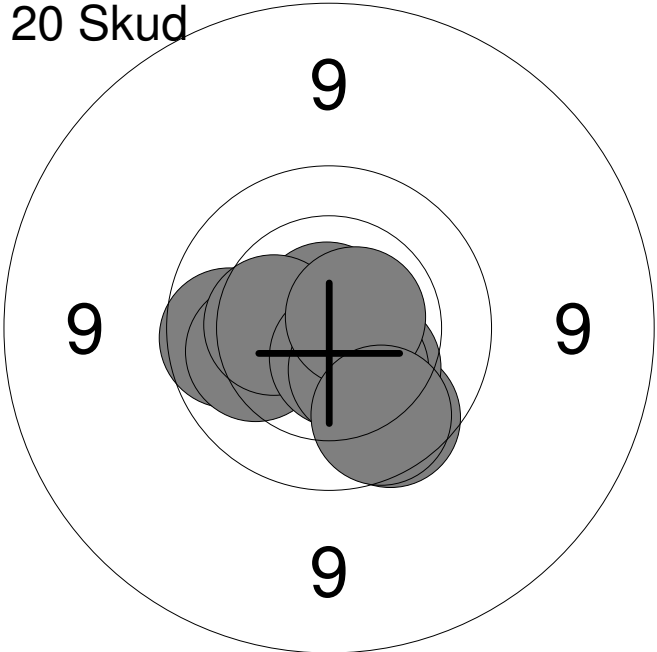
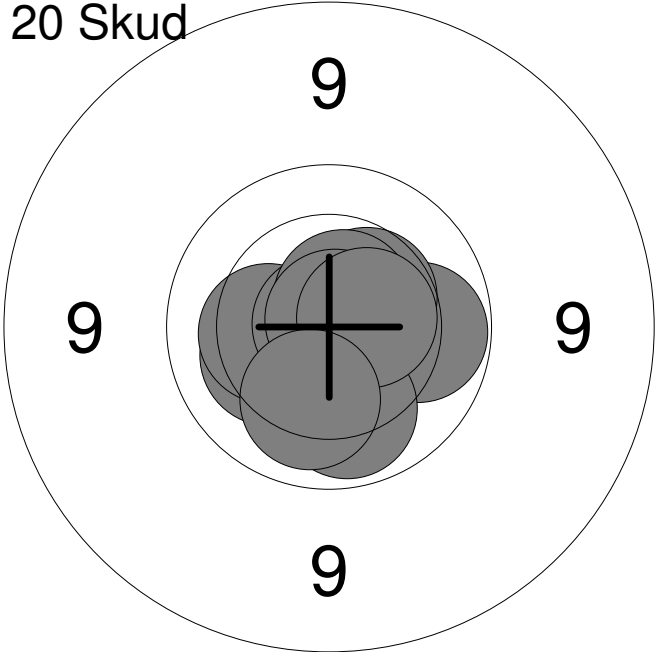
Hold	Skive	Jørgen Thomsen		
84	4	Hobro Egnens Skytteforening		ÅK1
24.10.2013	15 meter riffelstævne 2013		Aalborg Skyttekreds	
Prøve		1: 9.9	↑	
		2: 10.4	↖	
		3: 10.6x	↙	
		4: 10.7x	↘	
		5: 10.0	←	
		6: 10.7x	↙	
		Serie	59.0	
		Total	0.0	
20 Skud		1: 9.9	←	
		2: 10.1	←	
		3: 10.8x	↑	
		4: 9.9	↙	
		5: 10.3	←	
		6: 10.6x	↙	
		7: 10.3	↙	
		8: 10.4	↙	
		9: 10.6x	→	
		10: 9.9	↙	
		Serie	97.0	
		Total	97.0	
20 Skud		11: 10.0	→	
		12: 10.2	↙	
		13: 10.3	←	
		14: 10.4	↗	
		15: 10.9x	↖	
		16: 10.6x	↗	
		17: 10.0	↙	
		18: 10.8x	↗	
		19: 10.5x	→	
		20: 10.1	↙	
		Serie	100.0	
		Total	197.0	

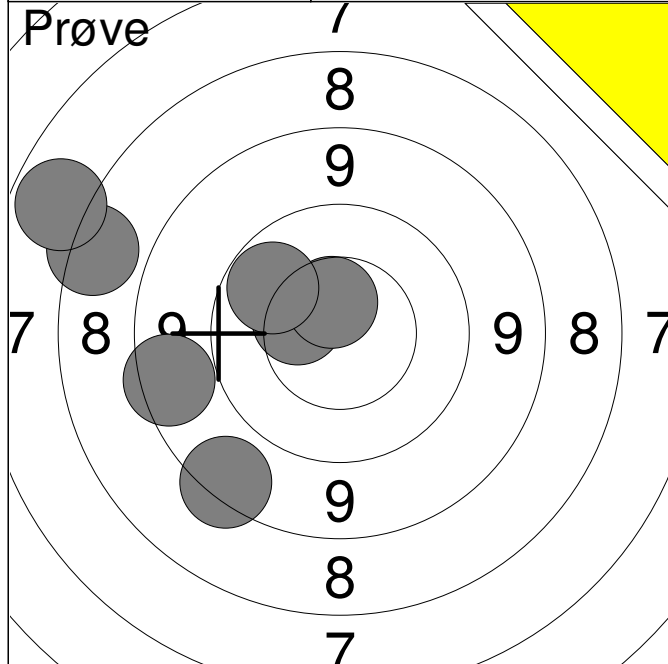

1:	8.6	↙
2:	8.7	←
3:	10.4	↗
4:	7.6	↗
5:	10.6	↗
6:	7.0	↗
7:	10.0	↗
Serie		60.0
Total		0.0

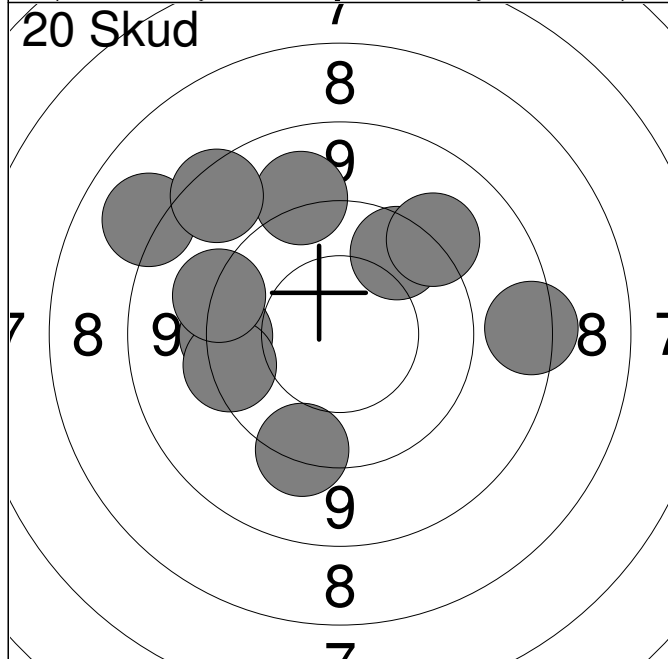

1:	9.5	↘
2:	9.6	←
3:	8.2	↗
4:	9.3	↗
5:	9.6	←
6:	9.4	←
7:	8.6	→
8:	9.8	↗
9:	8.7	↗
10:	9.4	↗
Serie		87.0
Total		87.0

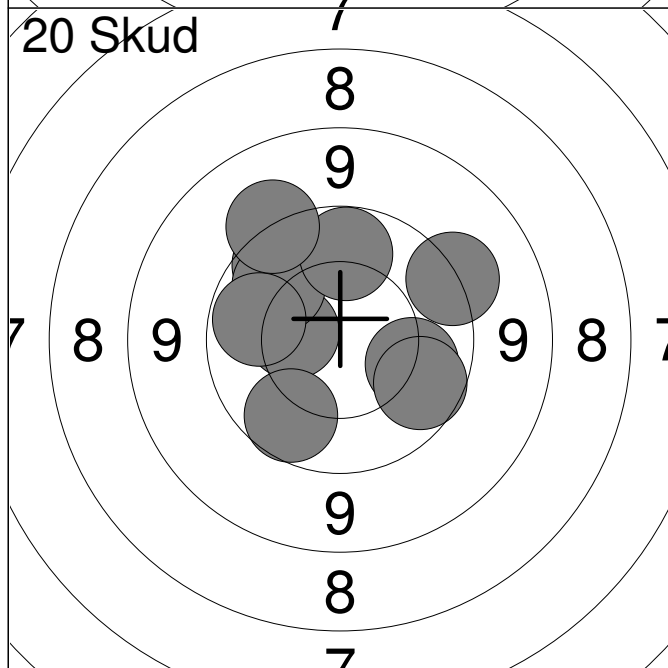

11:	10.1	→
12:	9.4	↗
13:	10.4	←
14:	9.9	↘
15:	9.8	↗
16:	10.0	↗
17:	10.0	←
18:	9.9	↗
19:	9.4	↗
20:	9.9	↘
Serie		94.0
Total		181.0

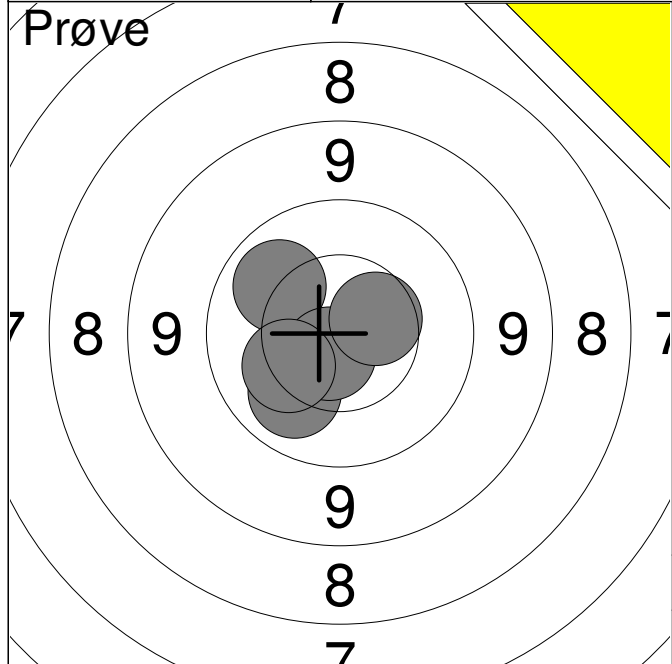

1:	10.1	↗
2:	10.1	↘
3:	10.7x	↘
4:	10.2	↙
5:	10.5	→
Serie		50.0
Total		0.0

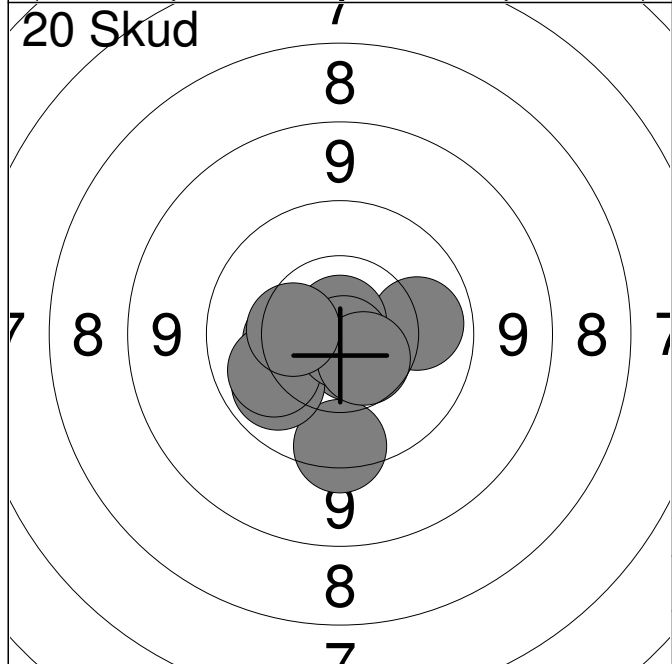

1:	10.7x	↘
2:	10.4	←
3:	9.6	↘
4:	10.0	↙
5:	10.0	→
6:	10.1	↙
7:	10.8x	↑
8:	10.8x	↘
9:	10.6	↘
10:	10.4	←
Serie		99.0
Total		99.0

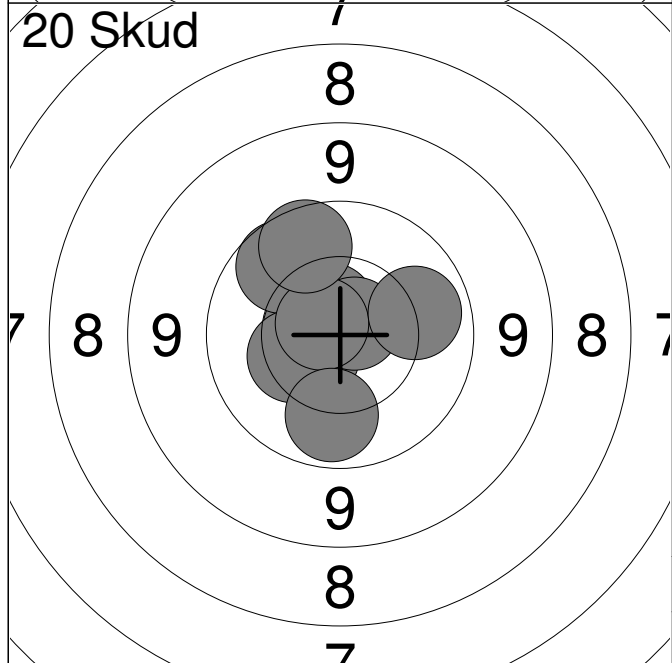

11:	10.6	↙
12:	10.6x	↑
13:	10.7x	↗
14:	10.6x	←
15:	9.9	↗
16:	10.4	↙
17:	10.7x	↗
18:	10.0	↘
19:	10.0	↗
20:	9.8	↑
Serie		98.0
Total		197.0

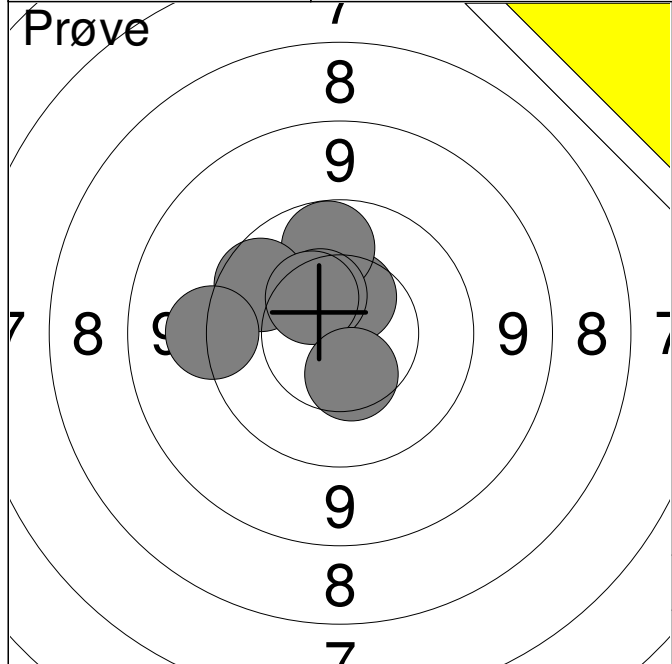

1:	10.5	↑
2:	9.9	↑
3:	10.5	↑
4:	9.9	↑
5:	10.4	↑
6:	9.4	←
7:	10.5	↓
Serie		67.0
Total		0.0

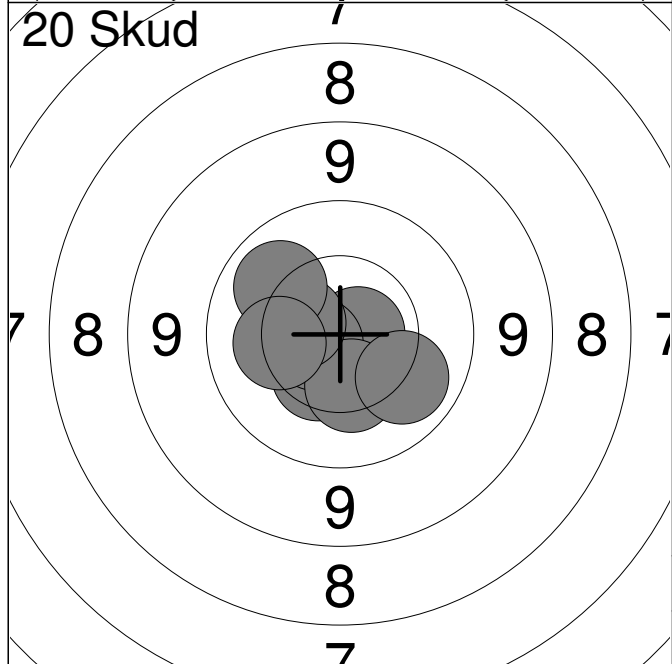

1:	10.8x	↘
2:	10.7x	↘
3:	10.7x	→
4:	10.4	↘
5:	10.7x	←
6:	10.3	↘
7:	10.5	↑
8:	10.1	↑
9:	10.2	←
10:	10.1	↘
Serie		100.0
Total		100.0

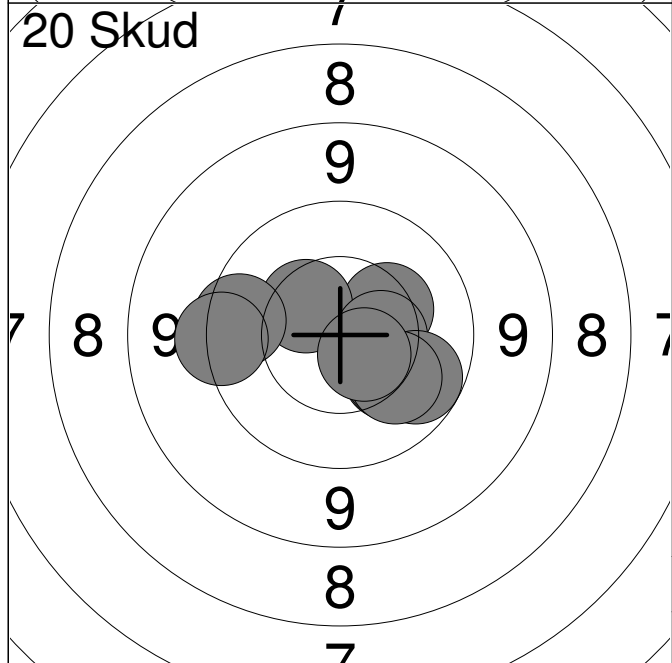

11:	10.2	↘
12:	10.3	→
13:	10.2	↘
14:	10.4	↑
15:	9.8	←
16:	9.5	←
17:	10.5	→
18:	10.0	↘
19:	10.1	↘
20:	10.6x	↘
Serie		98.0
Total		198.0

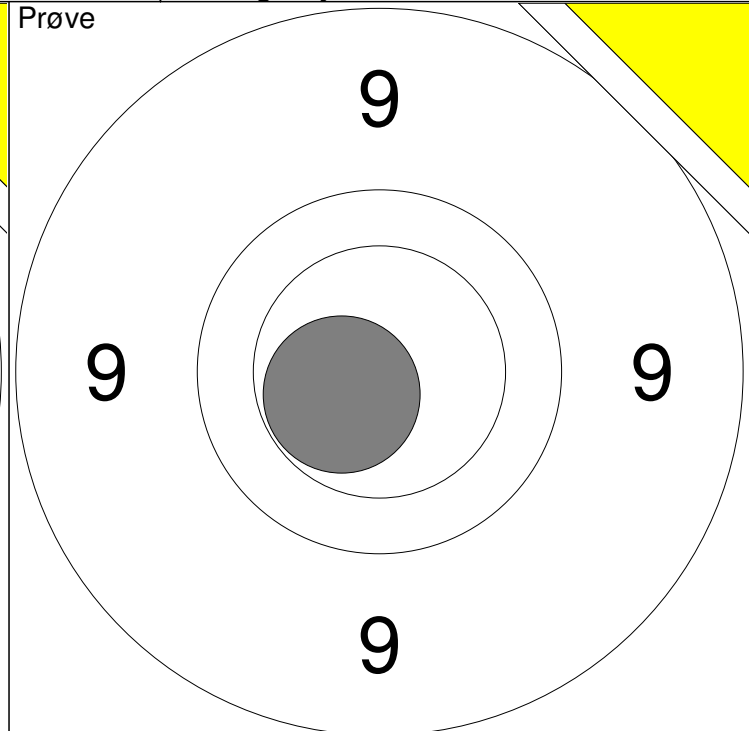
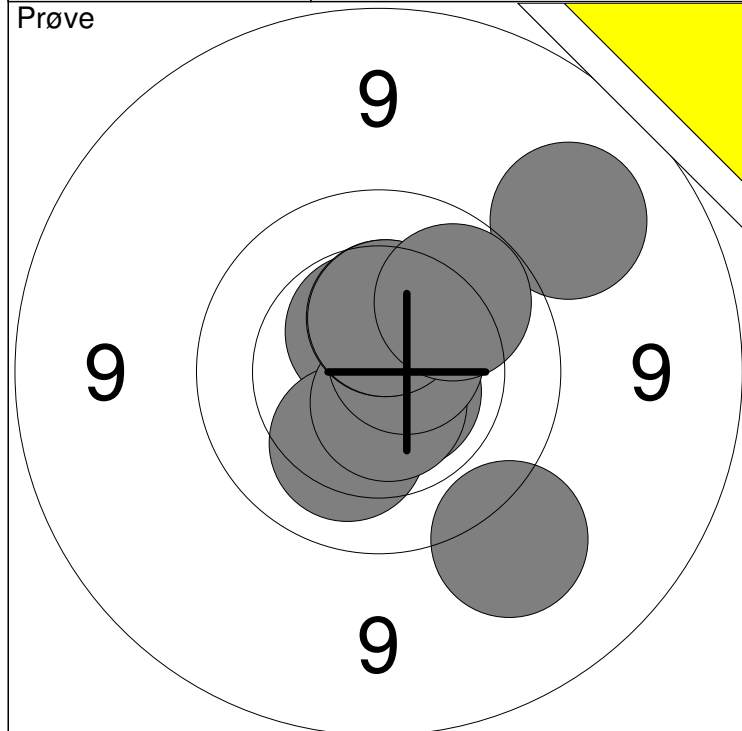

1: 9.4 ↘	6: 10.6x ↓	Serie	98
2: 10.5x ↗	7: 10.6x ↗		
3: 10.2 ↓	8: 10.4 ↑	Total	0
4: 10.6x ↘	9: 10.4 ↑		
5: 9.2 ↗	10: 10.0 ↗		

11: 10.5x ↙		Serie	10
		Total	0

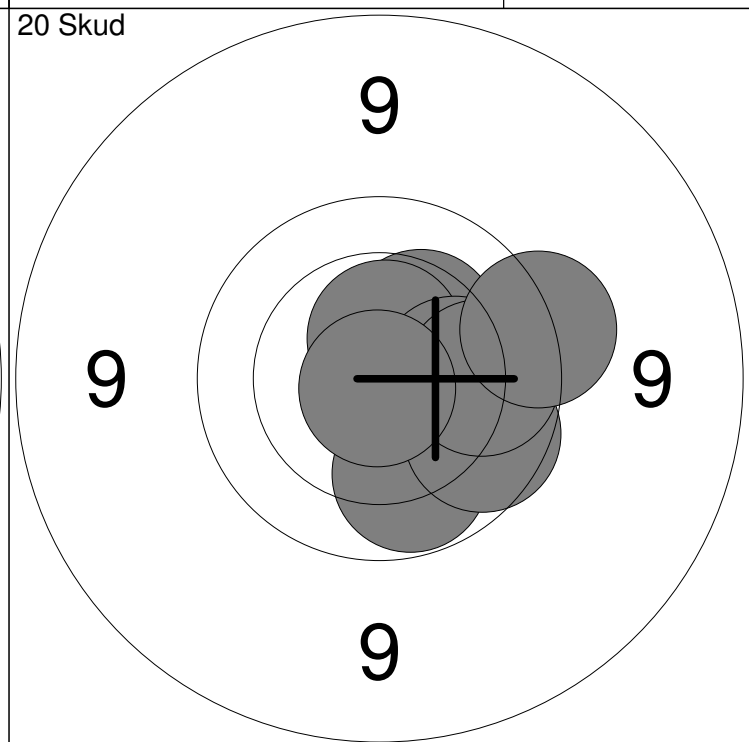
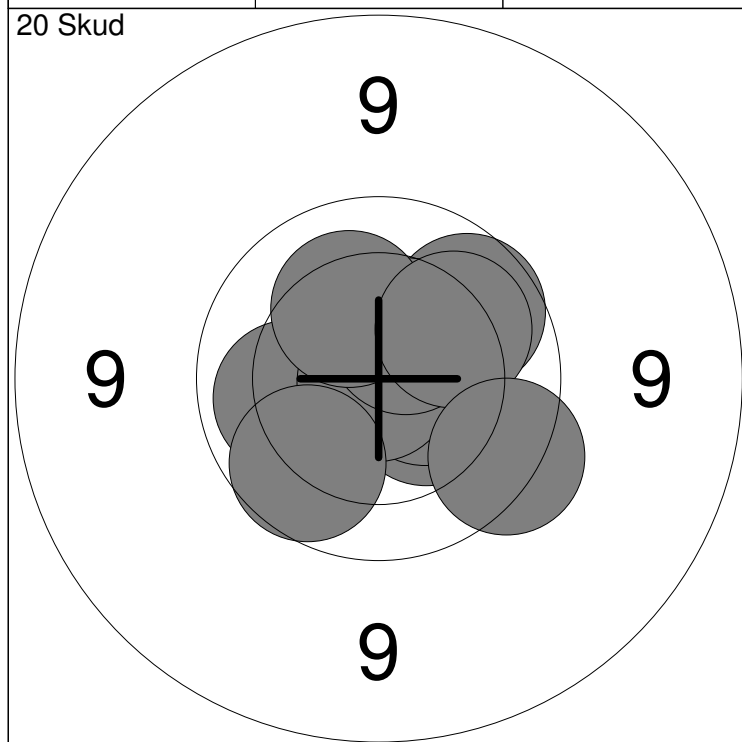

1: 10.4 ↘	6: 10.5 ↗	Serie	97
2: 9.9 ↗	7: 10.2 ↗		
3: 10.1 ←	8: 10.1 ↗	Total	97
4: 10.5x →	9: 9.9 ↓		
5: 10.9x ↙	10: 9.7 ↘		

11: 10.0 ↘	16: 10.2 →	Serie	98
12: 10.2 ↘	17: 9.9 ↘		
13: 10.3 ↗	18: 10.0 →	Total	195
14: 10.0 ↓	19: 10.9x ↓		
15: 10.6x ↑	20: 9.6 →		

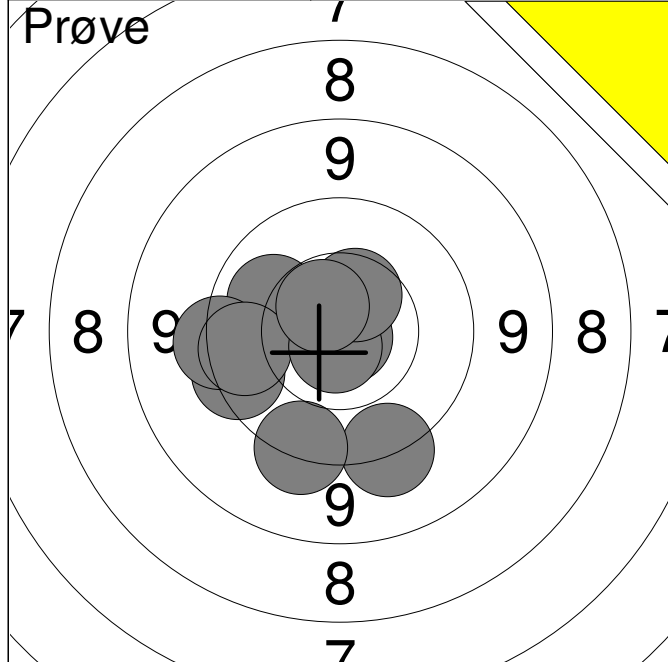

1:	9.4	↓
2:	9.5	↓
3:	10.1	↗
4:	10.9x	↓
5:	9.6	←
6:	9.5	←
7:	9.8	←
8:	10.8x	↓
9:	10.5	↗
10:	10.6x	↗
Serie		95.0
Total		0.0

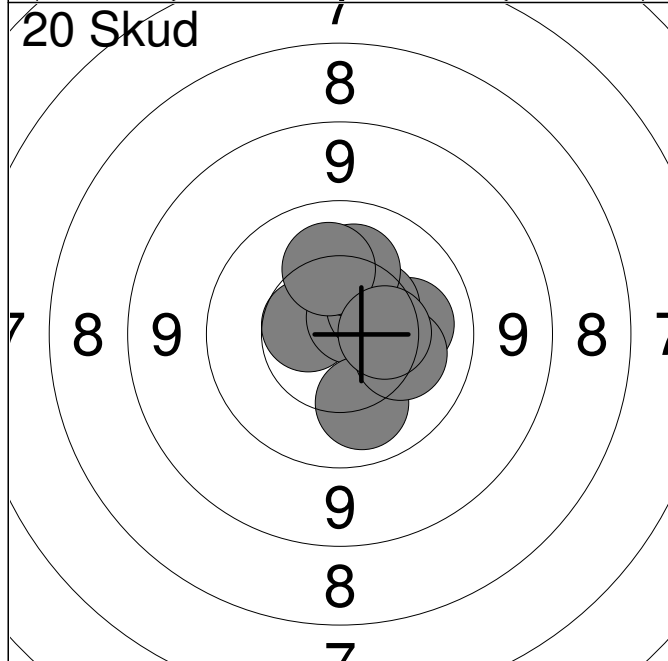

1:	10.2	↑
2:	10.6	←
3:	10.2	→
4:	10.7x	↗
5:	10.1	↓
6:	10.2	→
7:	10.4	↗
8:	10.2	↑
9:	10.2	↑
10:	10.4	→
Serie		100.0
Total		100.0

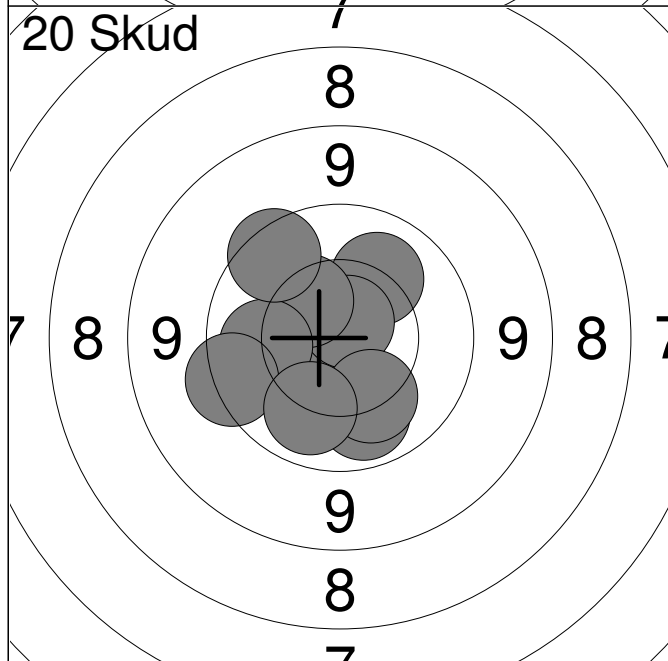

11:	10.6	←
12:	10.1	↗
13:	10.8x	↗
14:	10.0	↓
15:	10.2	↓
16:	10.4	↗
17:	10.1	←
18:	9.7	↗
19:	9.6	←
20:	10.1	↓
Serie		98.0
Total		198.0

Hold	Skive	Erik Skovmand		
84	10	Viborg Skytteforening		M1
24.10.2013	15 meter riffelstævne 2013		Aalborg Skyttekreds	
Prøve		1:	10.6x	↑
		2:	9.9	→
		3:	10.8x	→
		4:	10.4	↓
		5:	10.0	↗
		Serie		49.0
		Total		0.0
20 Skud		1:	10.2	→
		2:	10.2	←
		3:	9.9	↓
		4:	9.9	↓
		5:	10.8x	↗
		6:	10.3	→
		7:	10.1	↗
		8:	10.8x	↗
		9:	10.3	↓
		10:	10.8x	↓
		Serie		98.0
		Total		98.0
20 Skud		11:	9.7	↙
		12:	10.4	↗
		13:	10.3	↓
		14:	10.3	↗
		15:	10.6x	↙
		16:	10.7x	↗
		17:	10.7x	↓
		18:	10.5x	↗
		19:	10.5x	↓
		20:	10.1	↓
		Serie		99.0
		Total		197.0

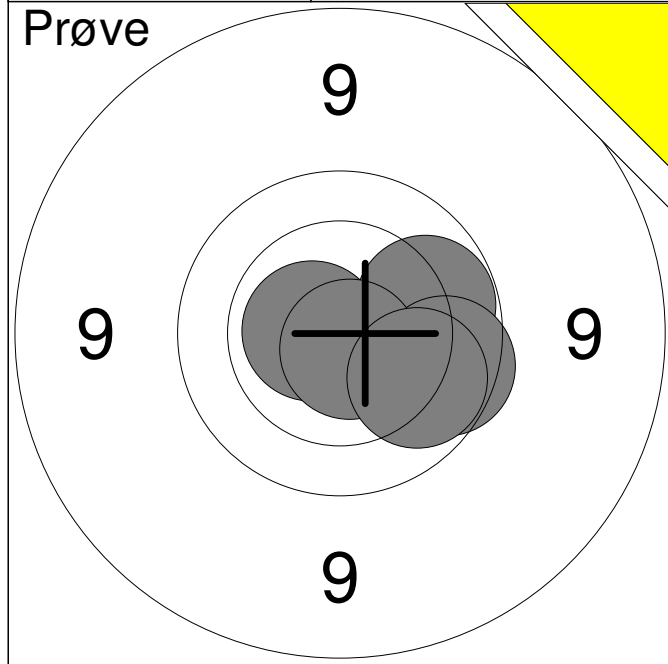

1:	10.0	→
2:	9.8	→
3:	10.6x	←
4:	10.8x	↘
5:	10.0	↘
Serie		49.0
Total		0.0

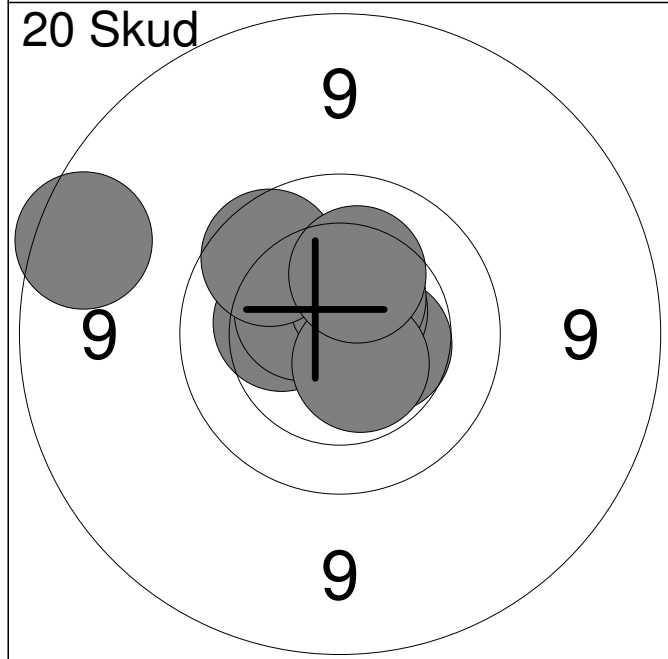

1:	10.5	→
2:	10.8x	↗
3:	10.3	←
4:	10.6x	↗
5:	10.5	↗
6:	8.9	←
7:	10.5x	↗
8:	10.6x	↘
9:	9.9	↗
10:	10.3	↗
Serie		97.0
Total		97.0

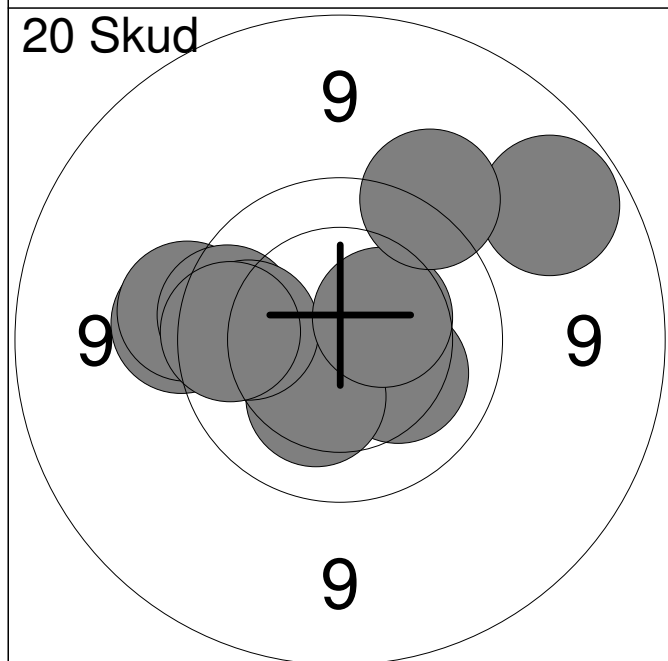

11:	10.2	↘
12:	10.3	↘
13:	9.5	←
14:	9.6	←
15:	9.0	↗
16:	9.8	←
17:	10.0	←
18:	10.4	↗
19:	9.5	↗
20:	9.8	←
Serie		94.0
Total		191.0

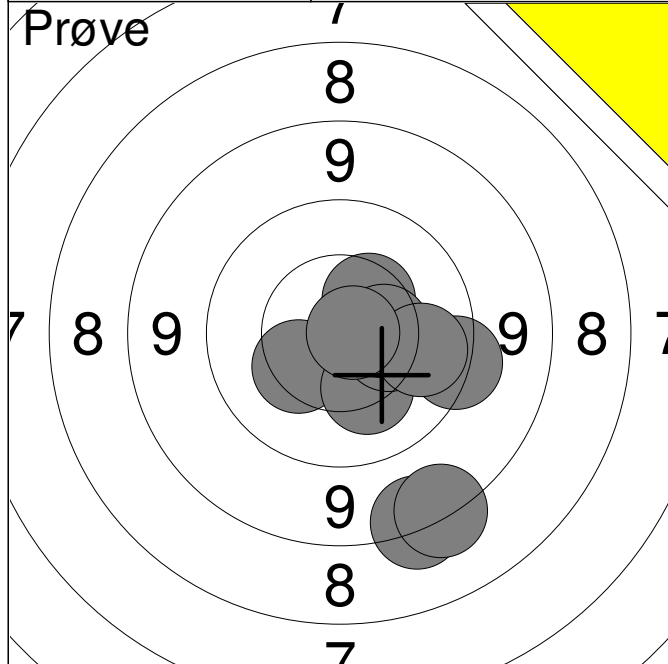

1:	8.5	↘
2:	8.5	↘
3:	10.4	↗
4:	9.5	→
5:	10.3	↖
6:	10.2	↘
7:	10.4	→
8:	10.4	→
9:	10.0	→
10:	10.8x	→
Serie	95.0	
Total	0.0	

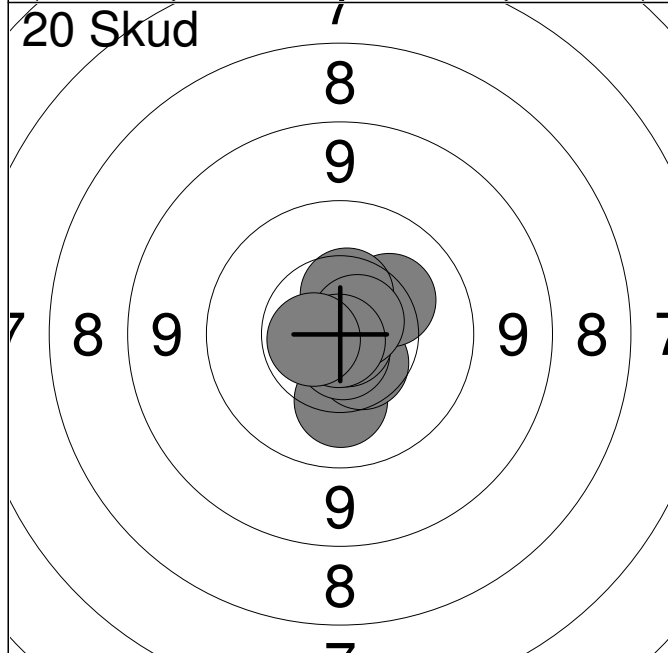

1:	10.6x	↘
2:	10.2	↓
3:	10.5	↘
4:	10.3	↗
5:	10.7x	↘
6:	10.9x	↘
7:	10.5	↑
8:	10.7x	↗
9:	10.9x	↓
10:	10.6x	←
Serie	100.0	
Total	100.0	

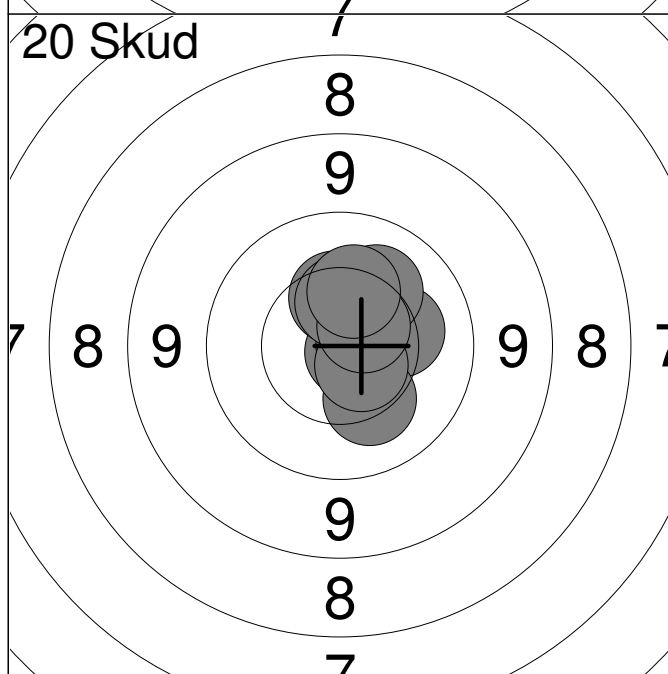

11:	10.8x	↗
12:	10.4	↑
13:	10.7x	→
14:	10.3	→
15:	10.2	↘
16:	10.4	↑
17:	10.6x	↘
18:	10.2	↗
19:	10.6x	↗
20:	10.3	↑
Serie	100.0	
Total	200.0	

Hold 85	Skive 1	Henrik Hyldahl Jensen	
-------------------	-------------------	------------------------------	--

15m	Aalborg Skyttekreds	MÅ1	
-----	---------------------	-----	--

24.10.2013	15 meter riffelstævne 2013	Aalborg Skyttekreds	
------------	----------------------------	---------------------	--

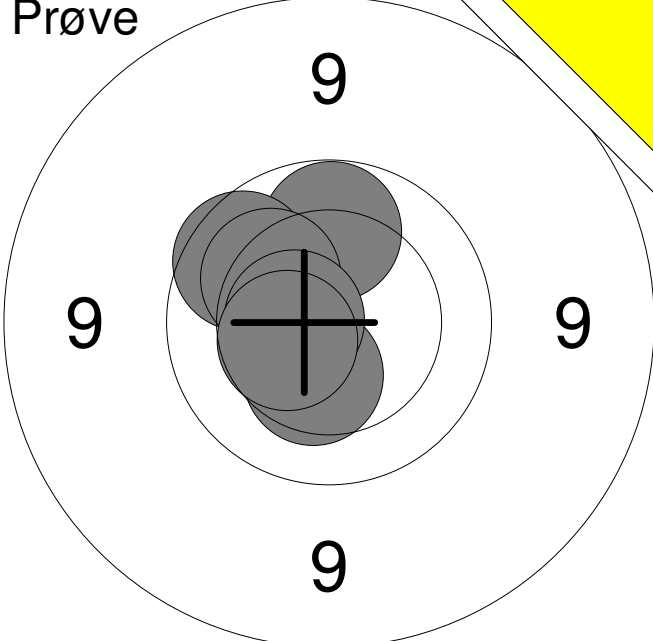
Prøve 	1: 10.0 ↑ 2: 9.9 ↗ 3: 10.4 ↓ 4: 10.2 ↗ 5: 10.6x ← 6: 10.5 ↙
	Serie 59.0 Total 0.0

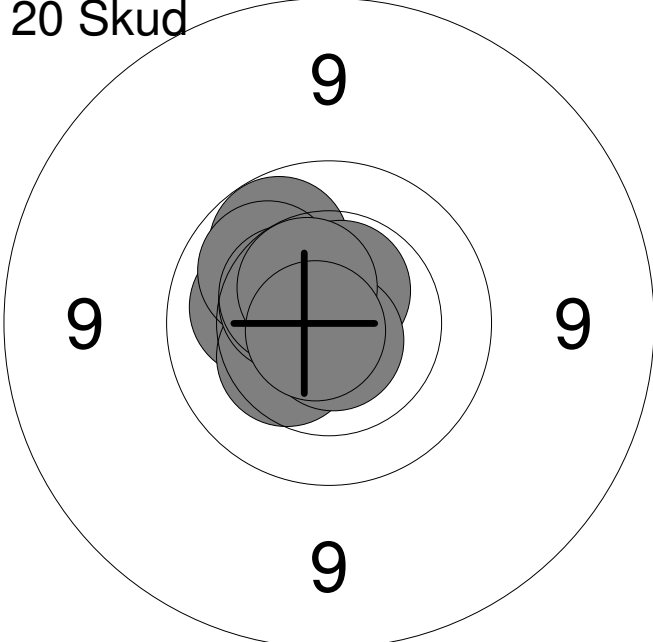
20 Skud 	1: 10.2 ← 2: 10.4 ↙ 3: 10.0 ↗ 4: 10.1 ↗ 5: 10.6x ↑ 6: 10.5 ↗ 7: 10.4 ↗ 8: 10.8x ↓ 9: 10.5x ↑ 10: 10.8x ↙
	Serie 100.0 Total 100.0

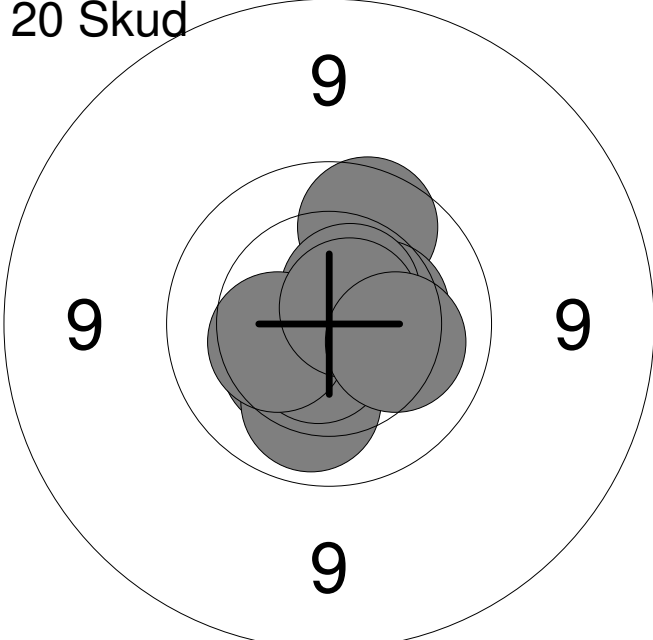
20 Skud 	11: 10.4 ↙ 12: 10.6x → 13: 10.1 ↓ 14: 9.9 ↑ 15: 10.4 → 16: 10.6x ↗ 17: 10.6x ↓ 18: 10.4 ← 19: 10.7x ↗ 20: 10.2 →
	Serie 99.0 Total 199.0

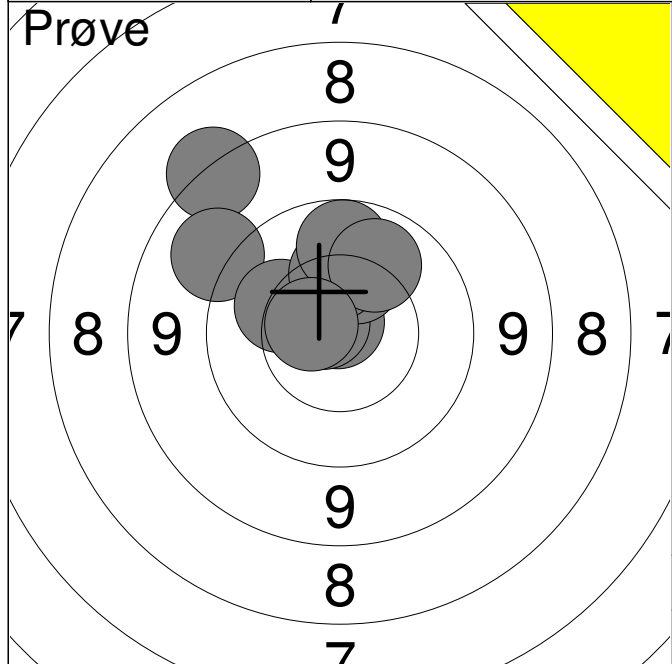

1:	8.5	↗
2:	10.8x	↑
3:	9.2	↗
4:	10.2	↗
5:	10.7x	↗
6:	10.3	↑
7:	10.3	↑
8:	9.9	↑
9:	10.1	↗
10:	10.6x	↖
Serie		96.0
Total		0.0

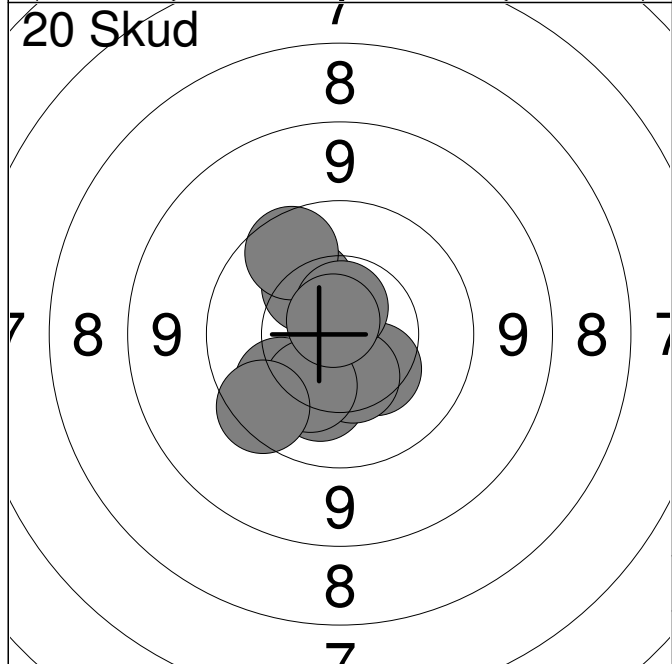

1:	10.2	↘
2:	10.3	↗
3:	9.8	↗
4:	10.4	↘
5:	10.4	↘
6:	10.1	↖
7:	10.3	↘
8:	9.7	↖
9:	10.6x	↑
10:	10.8x	↗
Serie		98.0
Total		98.0

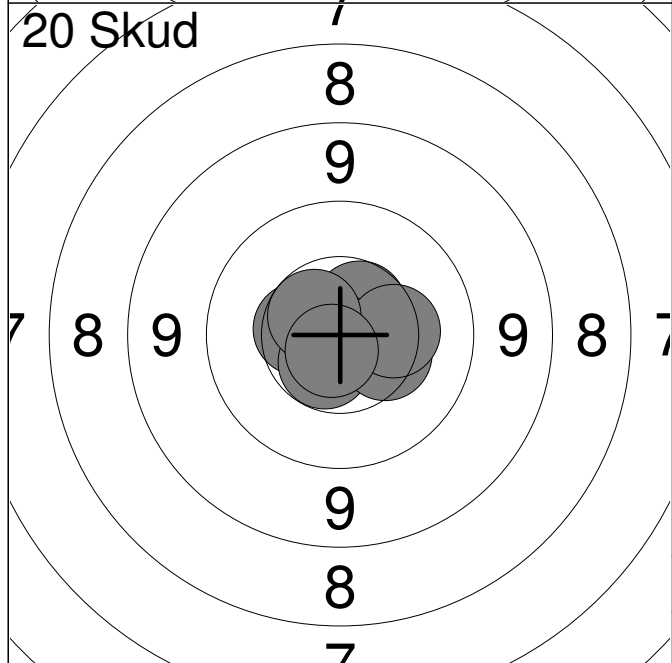

11:	10.9x	↗
12:	10.5	↖
13:	10.6x	↘
14:	10.4	→
15:	10.7x	↗
16:	10.6	↗
17:	10.9x	↖
18:	10.3	→
19:	10.6	↗
20:	10.7x	↘
Serie		100.0
Total		198.0

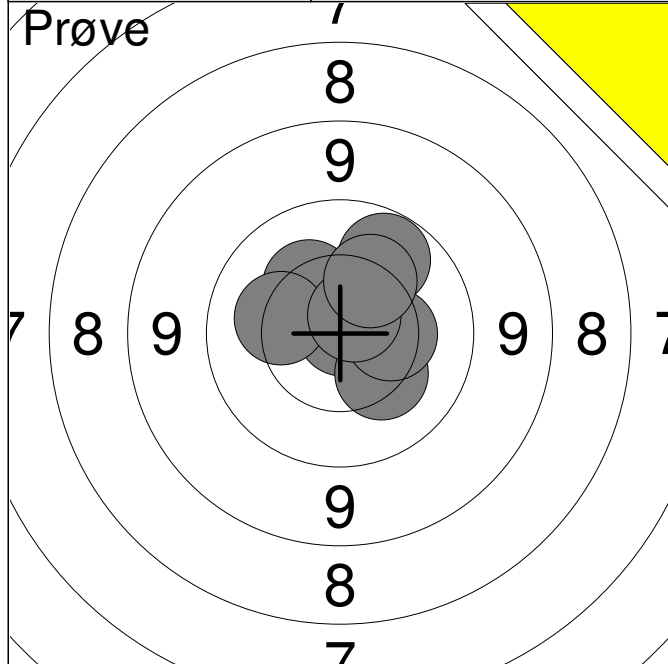

1:	10.9x	↗
2:	10.3	↗
3:	10.0	↗
4:	10.3	↘
5:	10.2	↖
6:	10.4	→
7:	10.7x	↗
8:	10.3	↗
Serie		80.0
Total		0.0

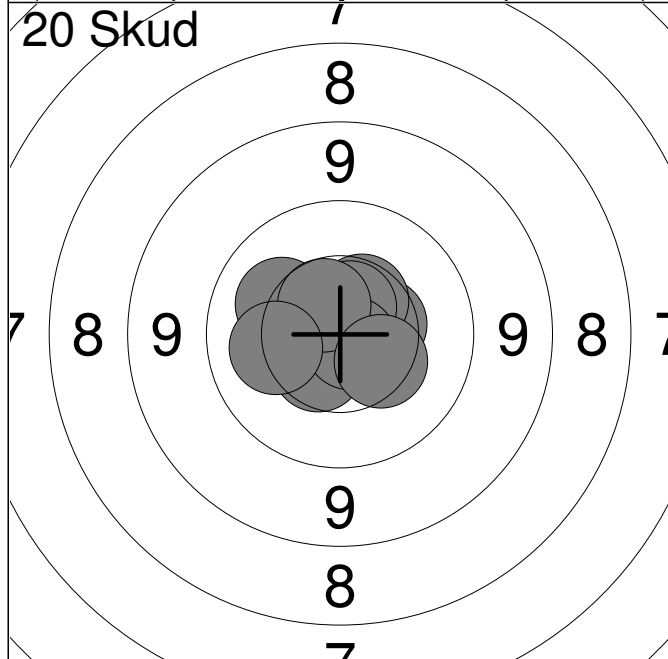

1:	10.2	↖
2:	10.5	→
3:	10.5	↗
4:	10.7x	←
5:	10.6x	↗
6:	10.5	↘
7:	10.8x	↘
8:	10.6	↗
9:	10.2	←
10:	10.4	↘
Serie		100.0
Total		100.0

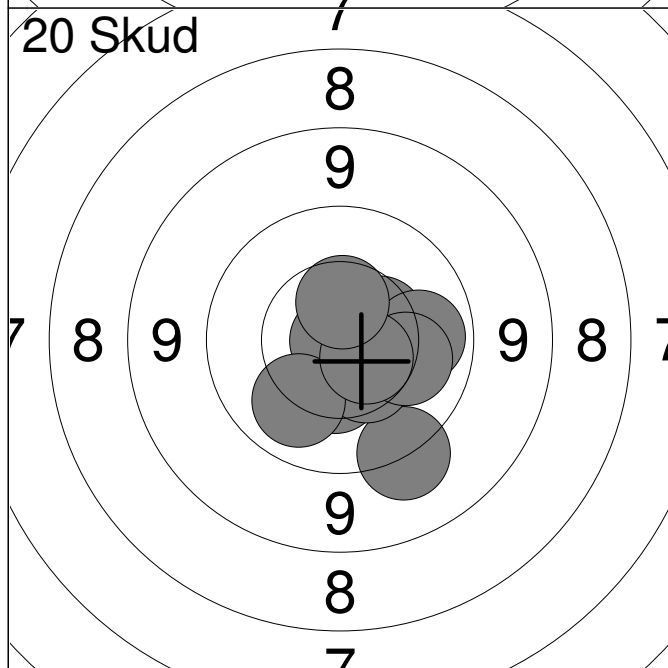

11:	9.4	↘
12:	10.4	↘
13:	10.5	→
14:	10.0	→
15:	10.4	↘
16:	10.2	→
17:	10.9x	←
18:	10.1	↘
19:	10.6	↘
20:	10.5	↑
Serie		99.0
Total		199.0

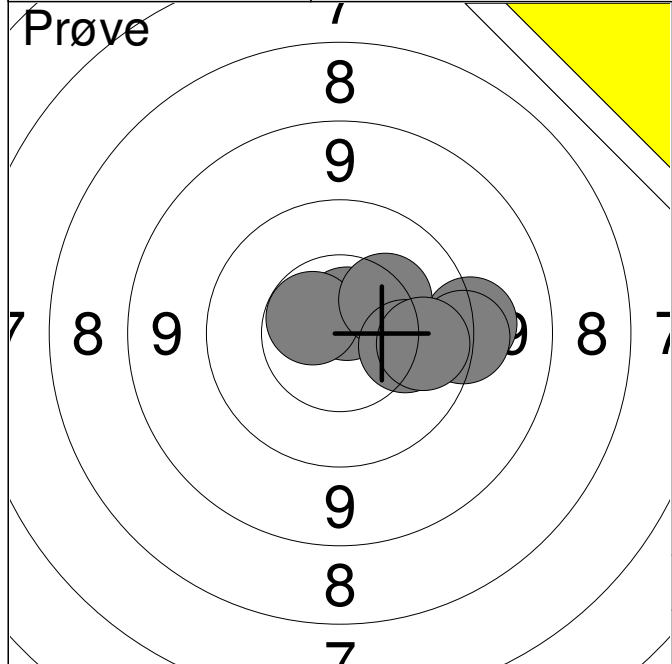

1:	10.7x	↑
2:	10.6x	↖
3:	9.4	→
4:	10.3	↗
5:	10.2	→
6:	9.5	→
7:	10.0	→
Serie		68.0
Total		0.0

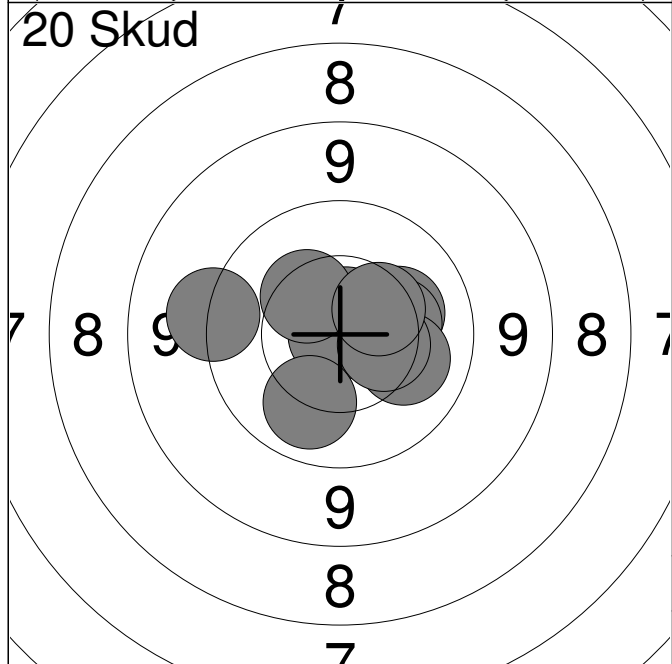

1:	10.2	→
2:	9.4	←
3:	10.7x	↑
4:	10.9x	←
5:	10.1	↙
6:	10.4	↗
7:	10.3	→
8:	10.2	→
9:	10.4	→
10:	10.4	↗
Serie		99.0
Total		99.0

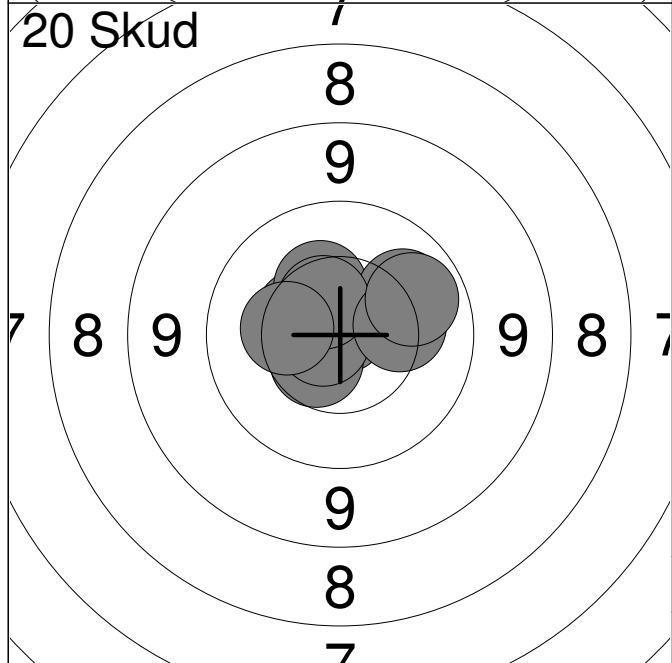

11:	10.5	↖
12:	10.8x	↑
13:	10.4	↑
14:	10.5	↙
15:	10.1	↗
16:	10.7x	←
17:	10.5	↗
18:	10.3	←
19:	10.3	→
20:	10.0	↗
Serie		100.0
Total		199.0

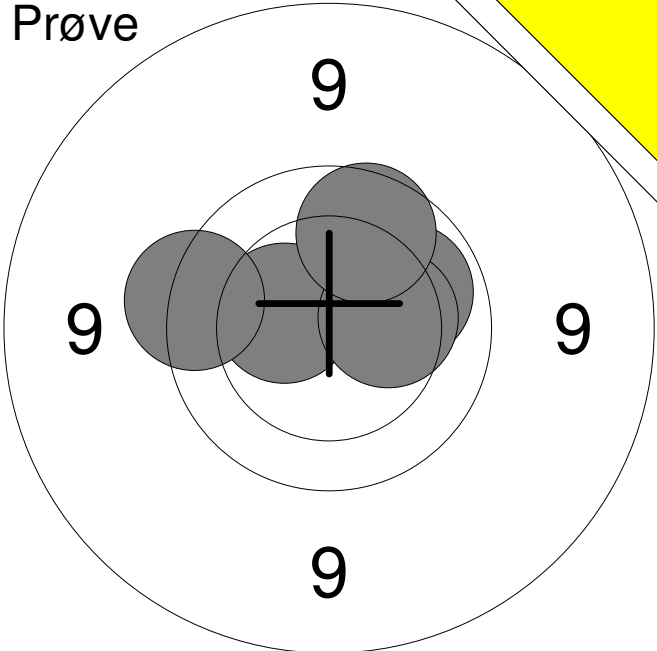
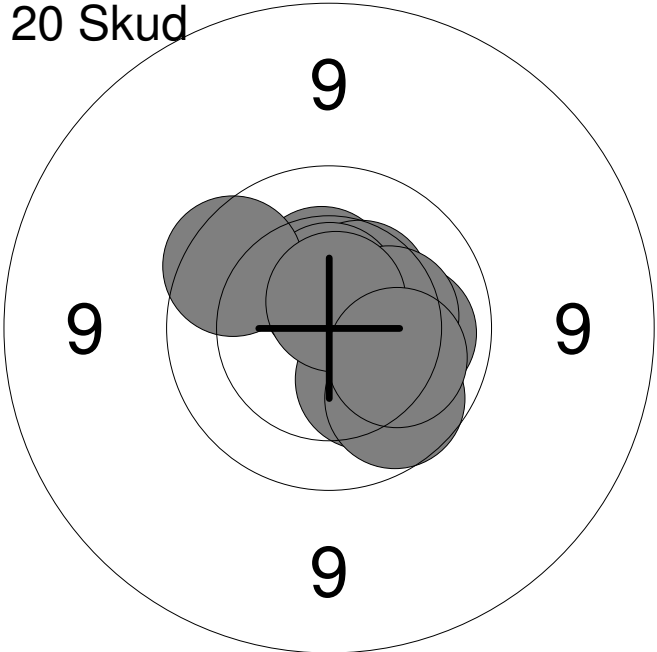
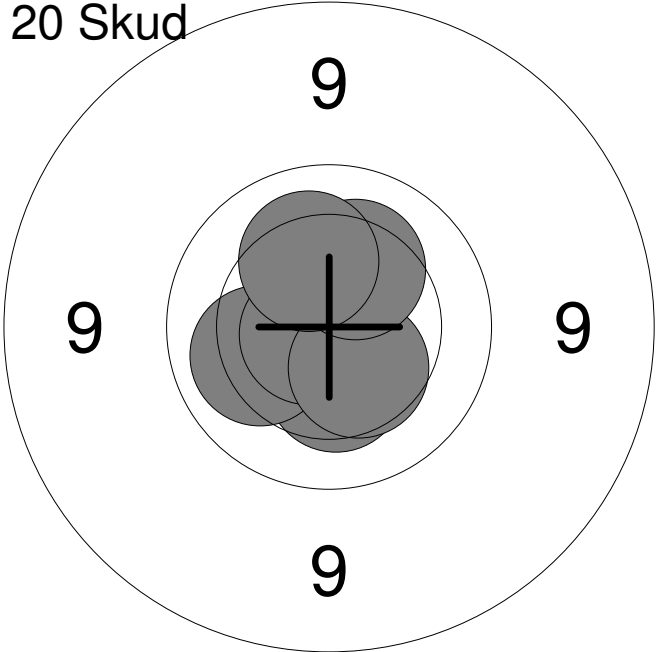
Hold	Skive	Jens Arne Abildgaard	
85	6	15m	Hobro Egnens Skytteforening
24.10.2013	15 meter riffelstævne 2013	Aalborg Skyttekreds	
Prøve		1: 10.4	←
		2: 9.7	←
		3: 10.1	→
		4: 10.3	→
		5: 9.9	↑
	Serie	48.0	
	Total	0.0	
20 Skud		1: 10.4	↑
		2: 10.1	→
		3: 10.4	↗
		4: 10.3	↘
		5: 10.6x	↑
		6: 10.3	→
		7: 9.8	↗
		8: 10.7x	↑
		9: 9.9	↘
		10: 10.2	↘
	Serie	98.0	
	Total	98.0	
20 Skud		11: 10.3	↘
		12: 10.7x	↗
		13: 10.1	←
		14: 10.8x	↗
		15: 10.9x	↘
		16: 10.4	↑
		17: 10.7x	←
		18: 10.4	↘
		19: 10.3	↗
		20: 10.2	↑
	Serie	100.0	
	Total	198.0	

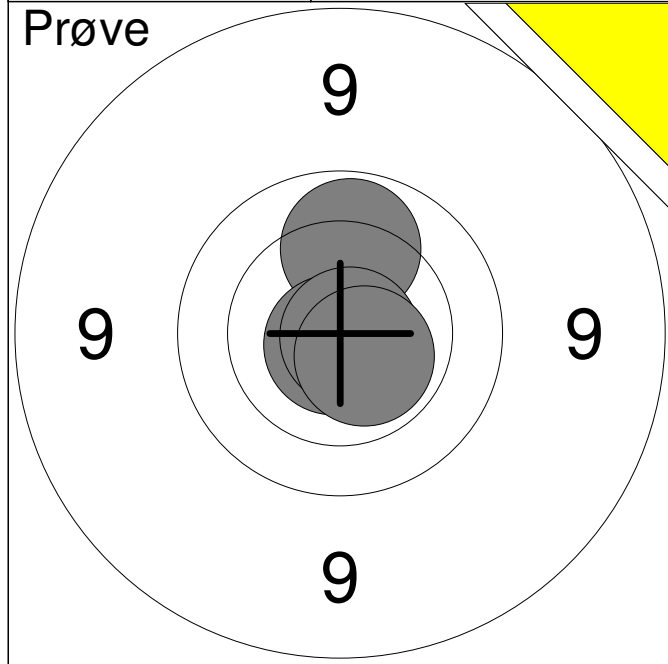

1:	10.0	↑
2:	10.8x	↓
3:	10.8x	→
4:	10.6x	↓
Serie		40.0
Total		0.0

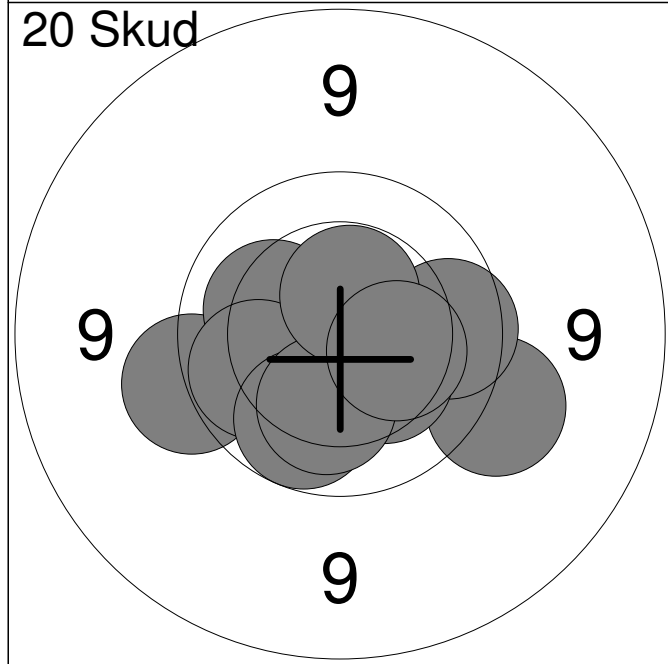

1:	9.5	→
2:	9.9	→
3:	10.3	↓
4:	9.6	←
5:	10.2	↑
6:	10.0	←
7:	9.9	↓
8:	10.2	↓
9:	10.5x	↑
10:	10.3	→
Serie		96.0
Total		96.0

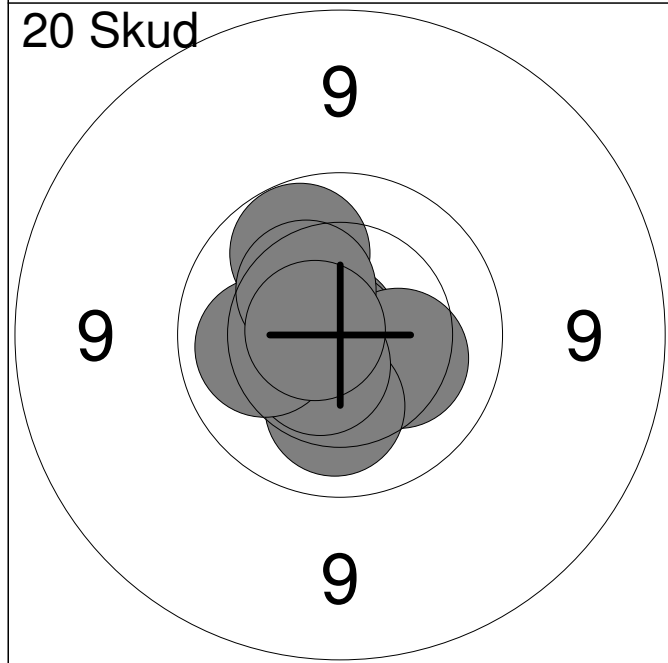

11:	10.8x	←
12:	10.9x	←
13:	10.3	→
14:	10.2	↓
15:	10.0	↑
16:	10.5x	↑
17:	10.6x	↓
18:	10.1	←
19:	10.3	↑
20:	10.7x	←
Serie		100.0
Total		196.0

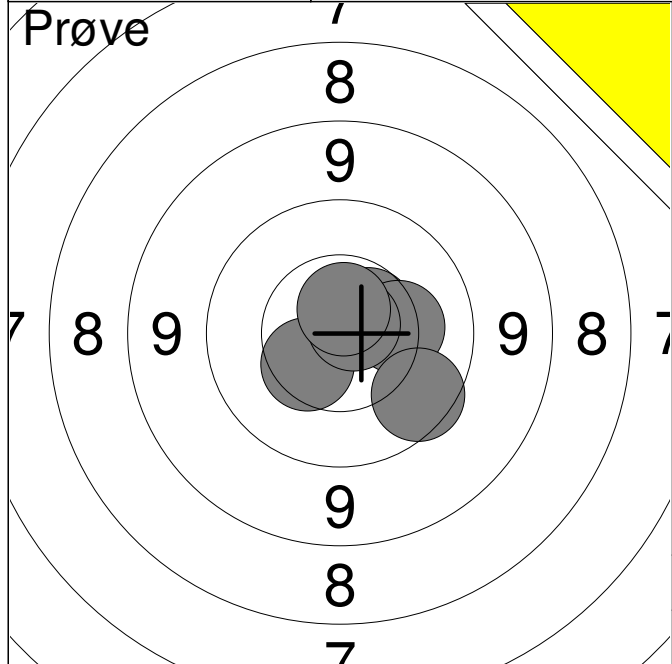

1:	10.4	↙
2:	10.6	↗
3:	10.3	→
4:	10.8x	↗
5:	9.8	↘
6:	10.7x	↑
Serie		59.0
Total		0.0

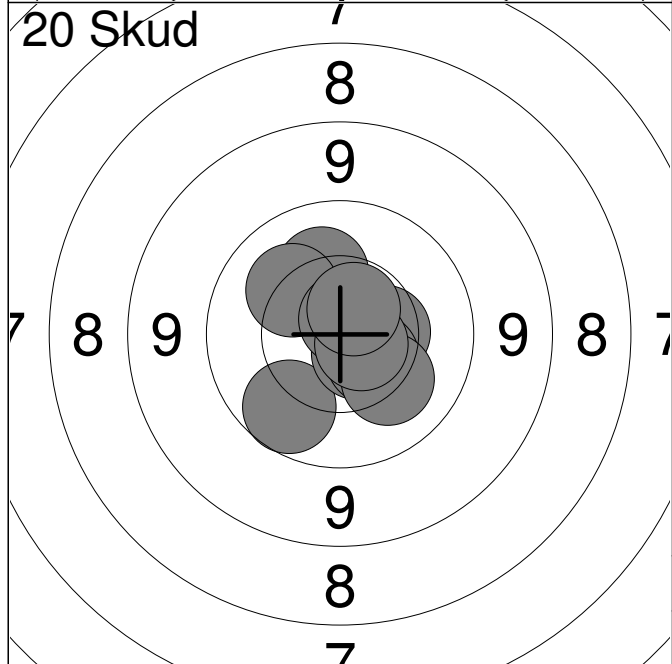

1:	10.2	↑
2:	10.2	↗
3:	9.9	↙
4:	10.6x	↘
5:	10.4	→
6:	10.8x	↑
7:	10.5	↘
8:	10.2	↘
9:	10.7x	→
10:	10.6x	↗
Serie		99.0
Total		99.0

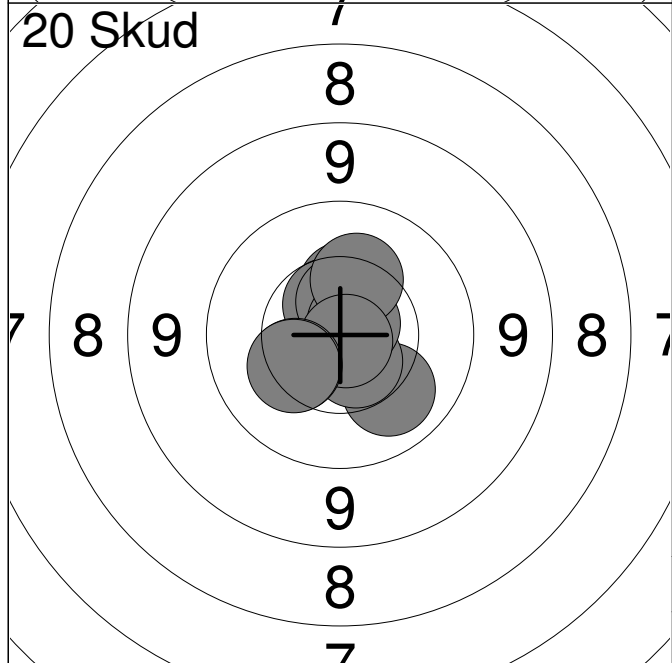

11:	10.1	↘
12:	10.4	↑
13:	10.6x	↘
14:	10.6	↑
15:	10.6	↑
16:	10.7x	↗
17:	10.3	↑
18:	10.9x	↘
19:	10.3	↙
20:	10.3	↙
Serie		100.0
Total		199.0

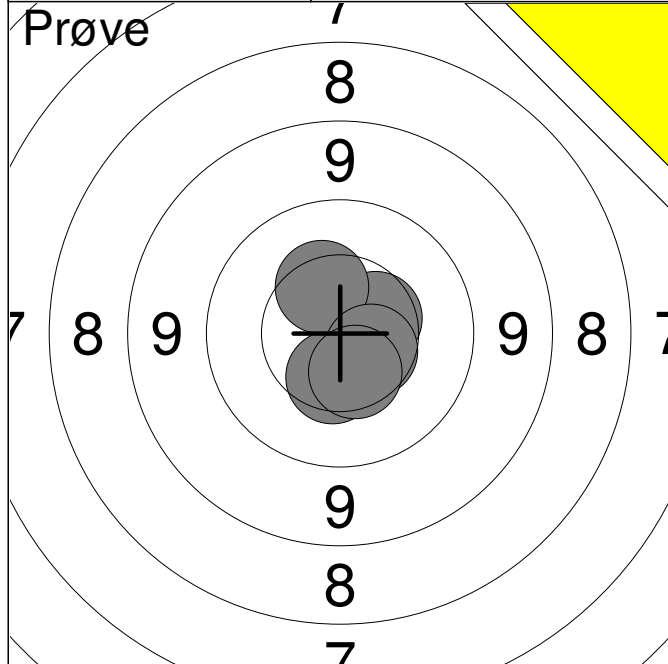

1:	10.4	↓
2:	10.5	→
3:	10.4	↑
4:	10.5	↘
5:	10.5	↓
Serie		50.0
Total		0.0

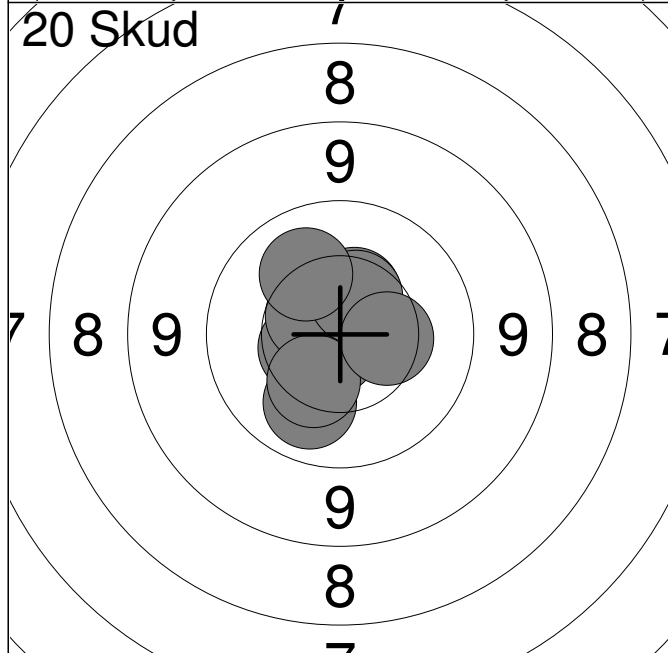

1:	10.8x	↓
2:	10.5	↗
3:	10.5	↑
4:	10.1	↓
5:	10.5	←
6:	10.6	↗
7:	10.5	↑
8:	10.3	↓
9:	10.4	→
10:	10.2	↗
Serie		100.0
Total		100.0

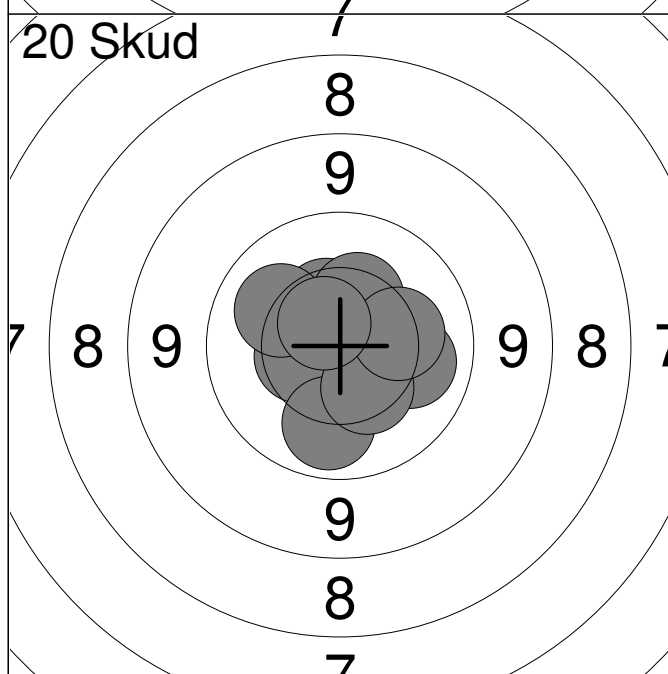

11:	10.6x	→
12:	10.1	→
13:	10.5	←
14:	10.0	↓
15:	10.5	↑
16:	10.4	↓
17:	10.2	↗
18:	10.4	↑
19:	10.3	→
20:	10.6x	↗
Serie		100.0
Total		200.0

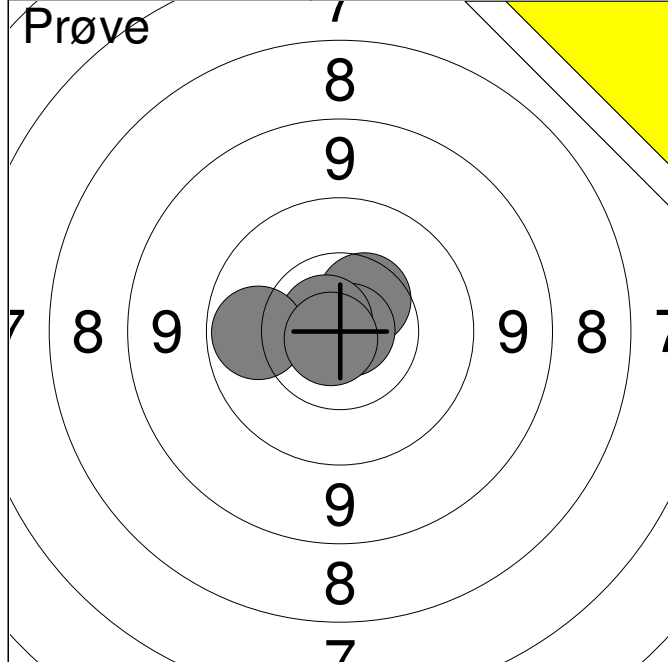

1:	10.5	↗
2:	10.9x	→
3:	10.7x	↖
4:	10.0	←
5:	10.8x	↙
Serie		50.0
Total		0.0

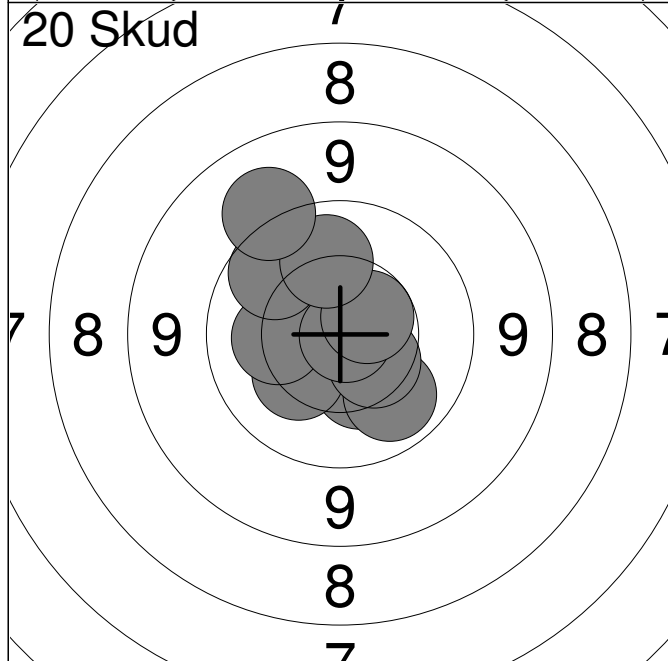

1:	10.3	↘
2:	10.0	↘
3:	10.3	↙
4:	10.2	←
5:	10.4	↘
6:	10.9x	→
7:	10.6	↗
8:	9.9	↗
9:	10.1	↗
10:	9.3	↗
Serie		98.0
Total		98.0

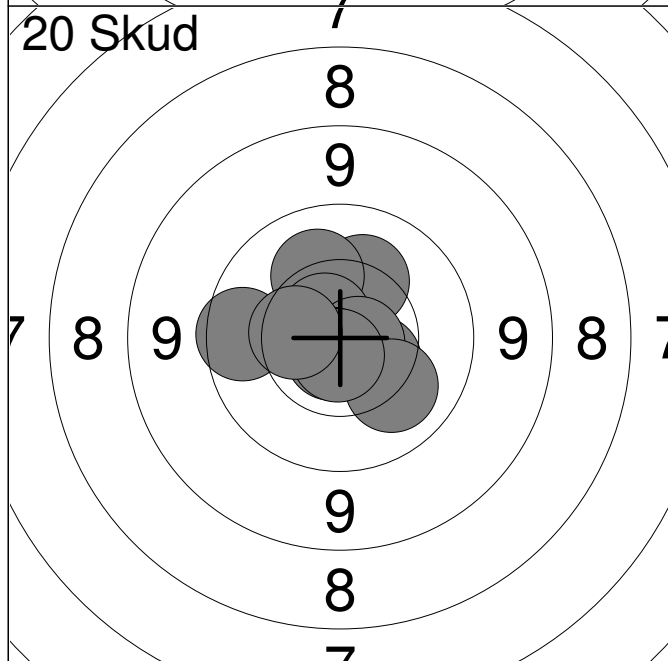

11:	10.2	↗
12:	10.2	↗
13:	10.7x	↗
14:	10.5	↘
15:	10.7x	→
16:	10.7x	↙
17:	10.1	↘
18:	10.7x	↘
19:	9.8	←
20:	10.4	←
Serie		99.0
Total		197.0

Hold 85	Skive 11	Mathias Levinsen
-------------------	--------------------	-------------------------

15m	Vilsted Skf.	MB1
-----	--------------	-----

24.10.2013	15 meter riffelstævne 2013	Aalborg Skyttekreds
------------	----------------------------	---------------------

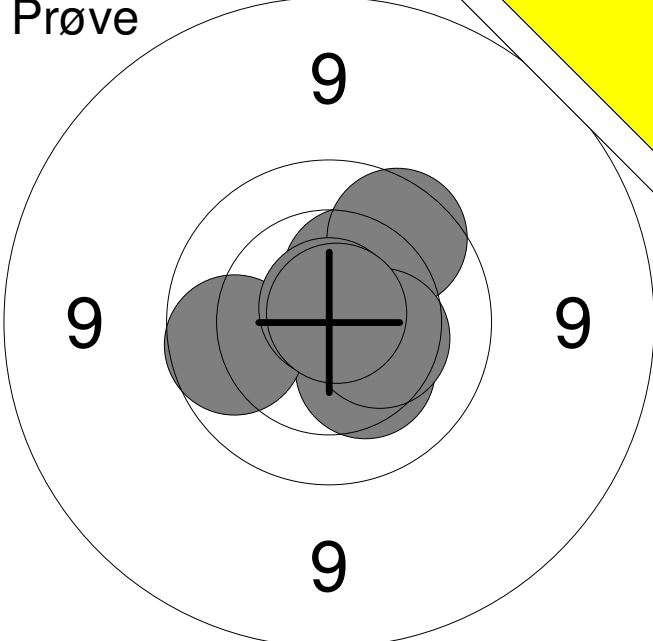
Prøve 	1: 10.3	↘
	2: 9.9	←
	3: 10.4	↗
	4: 9.9	↗
	5: 10.8x	↑
	6: 10.4	→
	7: 10.8x	↗
	Serie	68.0
	Total	0.0

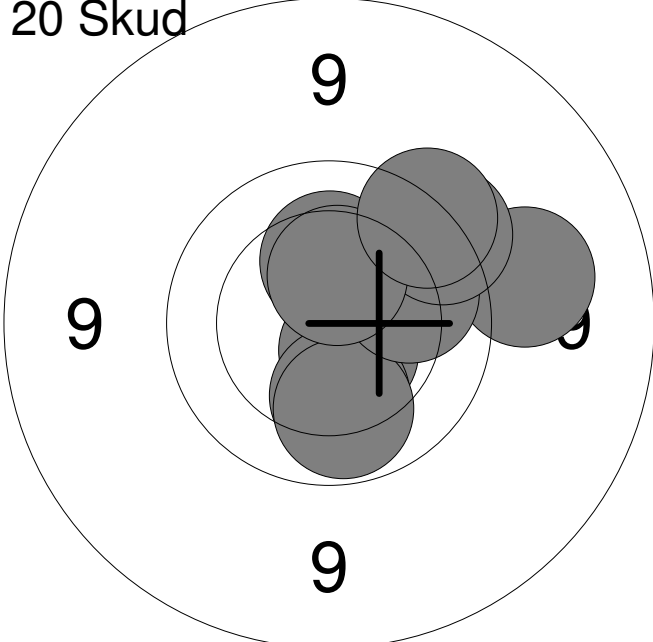
20 Skud 	1: 10.6x	↘
	2: 10.3	↑
	3: 10.2	↗
	4: 10.2	↓
	5: 10.0	↓
	6: 9.3	→
	7: 10.0	↗
	8: 9.6	↗
	9: 10.4	↑
	10: 9.6	↗
	Serie	97.0
	Total	97.0

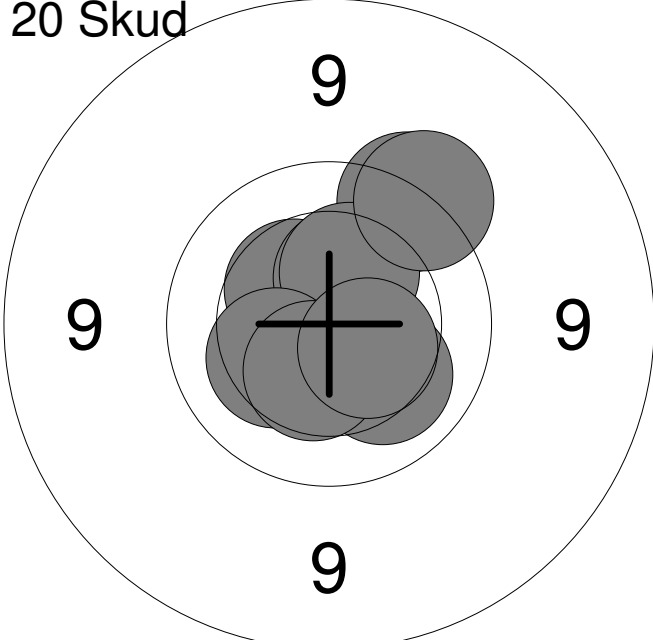
20 Skud 	11: 10.4	↖
	12: 10.4	↑
	13: 10.2	↘
	14: 9.6	↗
	15: 10.7x	↓
	16: 10.3	↑
	17: 10.3	←
	18: 10.4	↓
	19: 10.5	↘
	20: 9.6	↗
	Serie	98.0
	Total	195.0

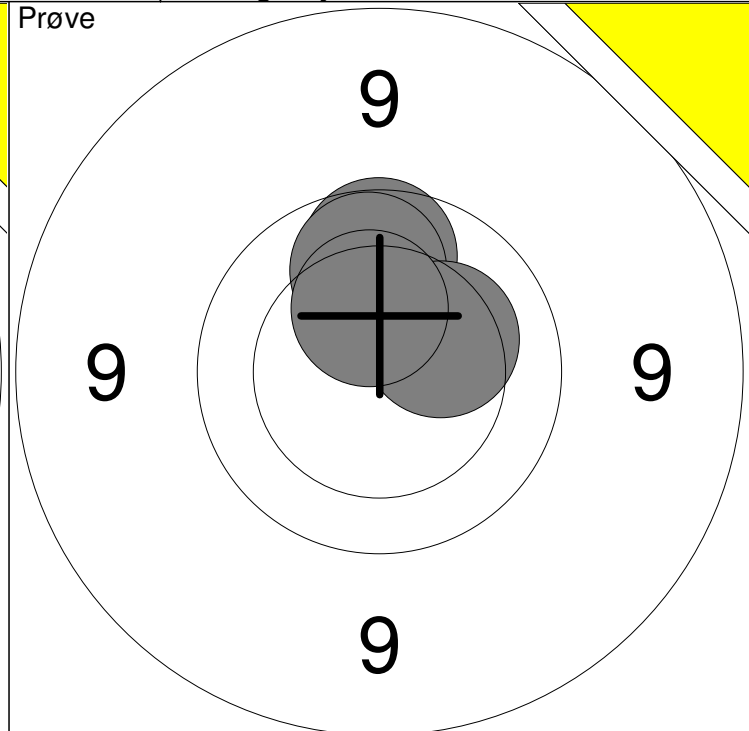
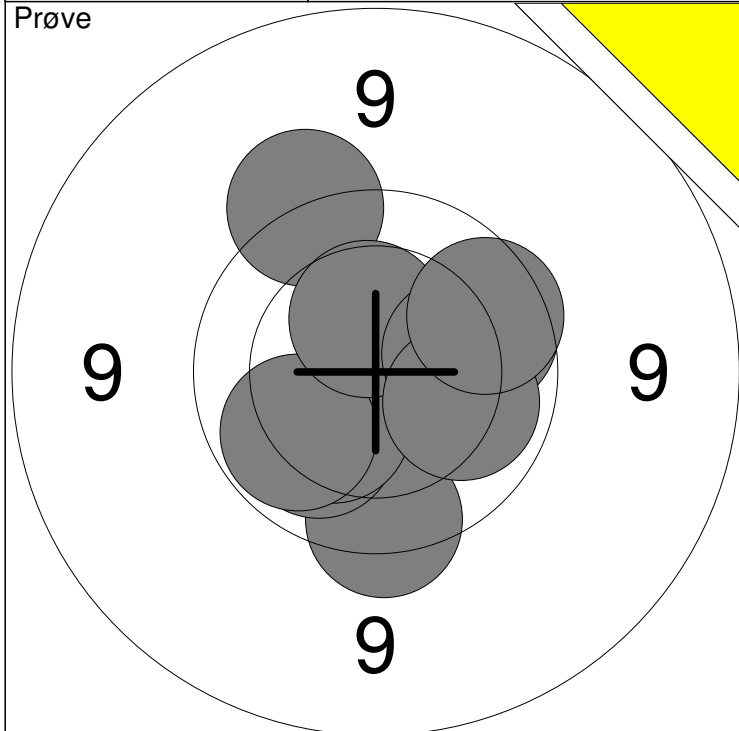

1: 9.7 ↓	6: 9.9 →	Serie	96
2: 10.1 ↙	7: 10.4 ↑		
3: 10.3 ↙	8: 10.1 →	Total	0
4: 10.0 ↙	9: 10.1 →		
5: 9.5 ↑	10: 9.8 →		

11: 9.9 ↑	Serie	39
12: 10.0 ↑		
13: 10.3 →	Total	0
14: 10.3 ↑		

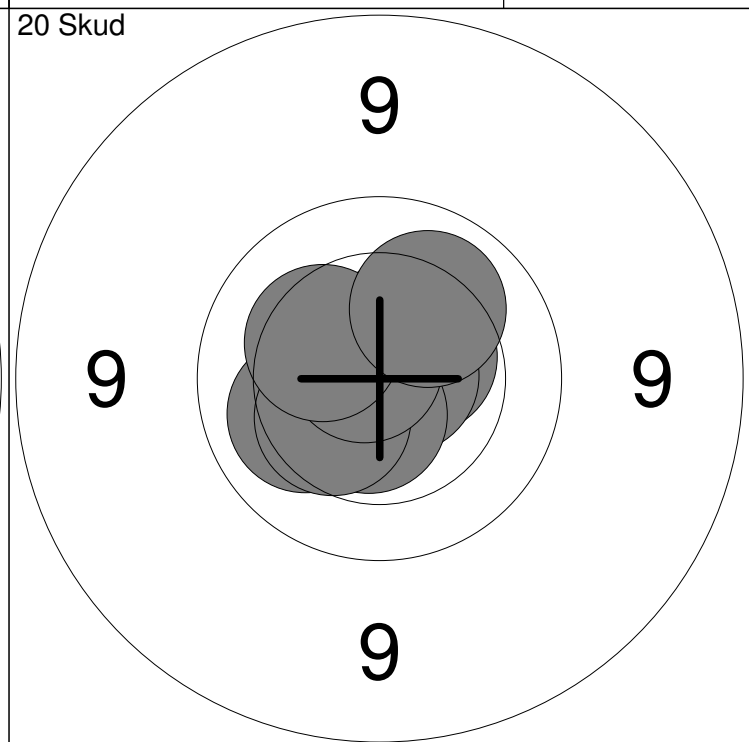
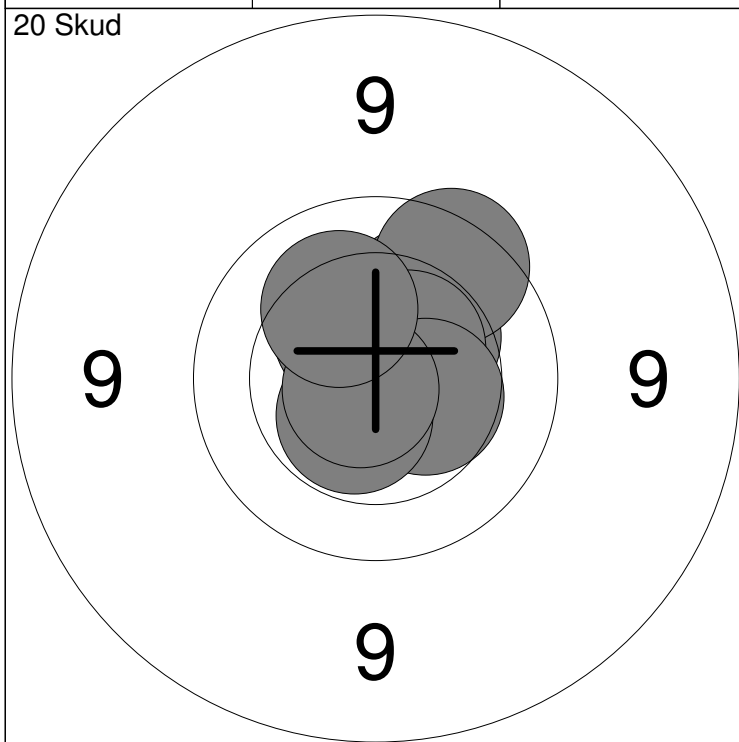

1: 10.5 ↑	6: 10.5x ↗	Serie	99
2: 10.1 ↑	7: 10.4 →		
3: 10.4 ↑	8: 10.5x ↘	Total	99
4: 10.3 ↗	9: 10.8x ↙		
5: 9.8 ↗	10: 10.2 ↑		

11: 10.2 ↙	16: 10.6x ↓	Serie	100
12: 10.5x ↗	17: 10.4 ↙		
13: 10.4 ↑	18: 10.8x ↙	Total	199
14: 10.7x →	19: 10.3 ↙		
15: 10.6x ↙	20: 10.1 ↑		